



US00D722090S

(12) **United States Design Patent**
Jeon et al.

(10) **Patent No.:** **US D722,090 S**
(45) **Date of Patent:** **** Feb. 3, 2015**

- (54) **REFRIGERATOR HANDLE**
- (71) Applicant: **Samsung Electronics Co., Ltd.**,
Suwon-si, Gyeonggi-do (KR)
- (72) Inventors: **Sang-Woon Jeon**, Namyangju-si (KR);
Se-Youn Park, Incheon (KR);
Jae-Moon Lee, Seoul (KR)
- (73) Assignee: **Samsung Electronics Co., Ltd.** (KR)
- (**) Term: **14 Years**
- (21) Appl. No.: **29/466,056**
- (22) Filed: **Sep. 4, 2013**
- (30) **Foreign Application Priority Data**

Mar. 5, 2013 (KR) 30-2013-0011114

- (51) **LOC (10) Cl.** **15-07**
- (52) **U.S. Cl.**
USPC **D15/89**
- (58) **Field of Classification Search**
USPC D15/79-90; 62/3.1, 3.6, 3.63, 3.64,
62/246-255; 312/400-409, 236, 352, 116,
312/128; D8/300-302, 305, 313-321;
D6/633; D7/393, 394, 402, 405
See application file for complete search history.

(56) **References Cited**
U.S. PATENT DOCUMENTS

D210,561 S *	3/1968	Roberts et al.	D15/89
D562,361 S *	2/2008	Kwak	D15/89
D579,310 S *	10/2008	Suh et al.	D8/315
D587,730 S *	3/2009	Yang et al.	D15/89

D588,172 S *	3/2009	Yang et al.	D15/89
D610,173 S *	2/2010	Kim	D15/89
D610,594 S *	2/2010	Martin et al.	D15/89
D610,595 S *	2/2010	Baker et al.	D15/89
D612,677 S *	3/2010	Jeon	D7/402
D614,012 S *	4/2010	Saubert et al.	D8/317
D614,013 S *	4/2010	Saubert et al.	D8/317
D629,023 S *	12/2010	Jeon et al.	D15/89

* cited by examiner

Primary Examiner — Stella Reid
Assistant Examiner — Khawaja Anwar
(74) *Attorney, Agent, or Firm* — Cantor Colburn LLP

(57) **CLAIM**
We claim, the ornamental design for a refrigerator handle, as shown and described.

DESCRIPTION

FIG. 1 is a perspective view of a refrigerator handle, showing our new design;
FIG. 2 is a front elevation view thereof;
FIG. 3 is a rear elevation view thereof;
FIG. 4 is a side elevation view thereof;
FIG. 5 is a another side elevation view thereof;
FIG. 6 is a top plan view thereof;
FIG. 7 is a bottom plan view thereof;
FIG. 8 is a perspective view thereof, showing a refrigerator handle in use condition; and,
FIG. 9 is an enlarged cross-sectional view thereof, as taken along the lines 9-9 in FIG. 2.
The broken lines in FIG. 8 of the drawings show environment only and form no part of the claimed design.

1 Claim, 6 Drawing Sheets

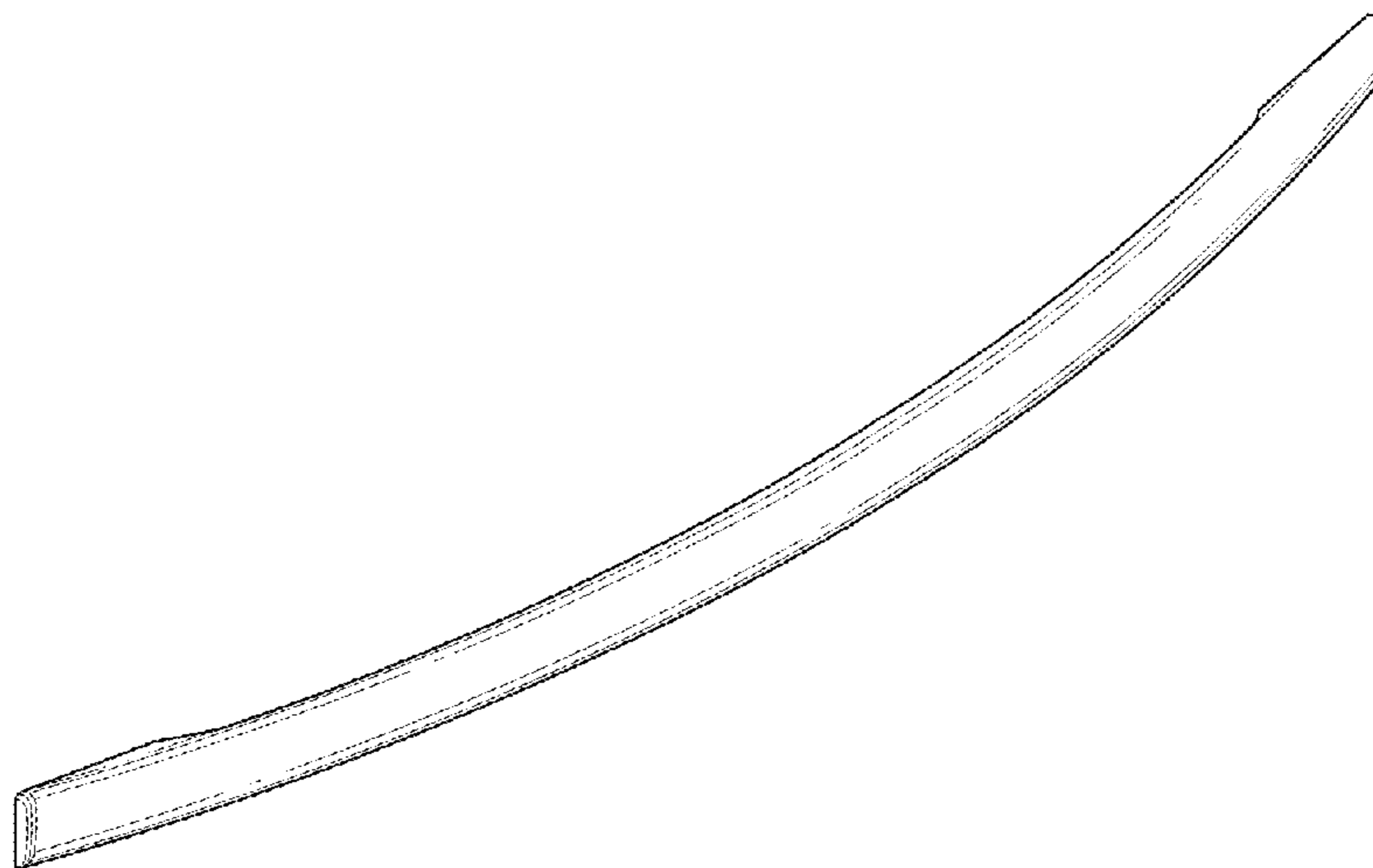

FIG. 1

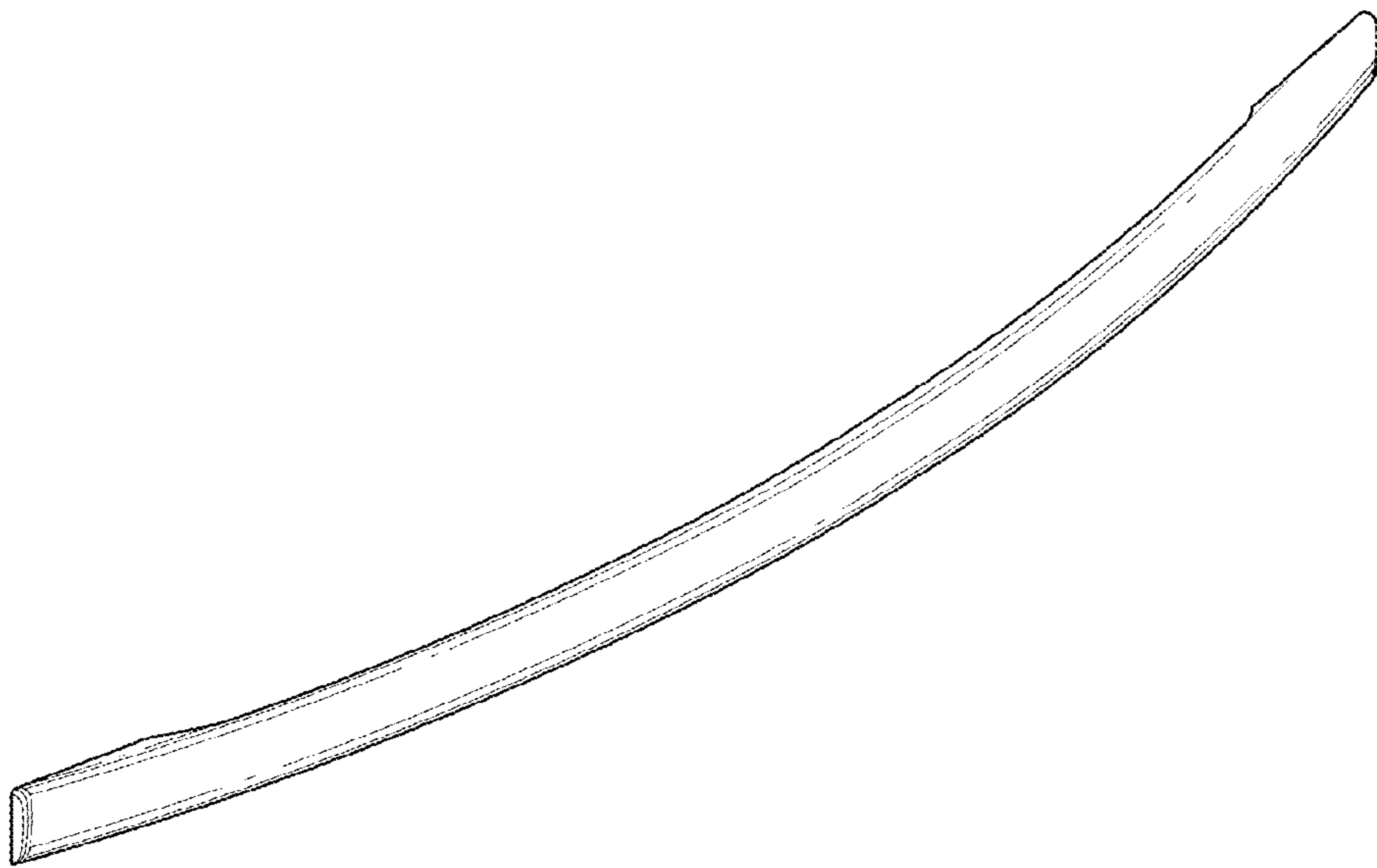

FIG. 2

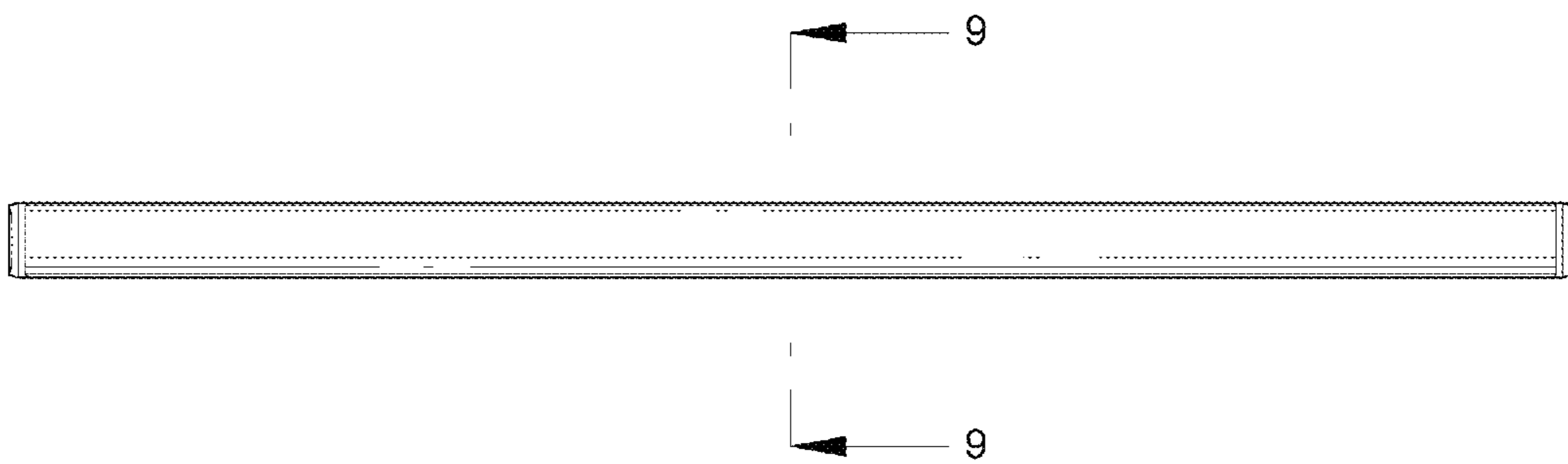

FIG. 3

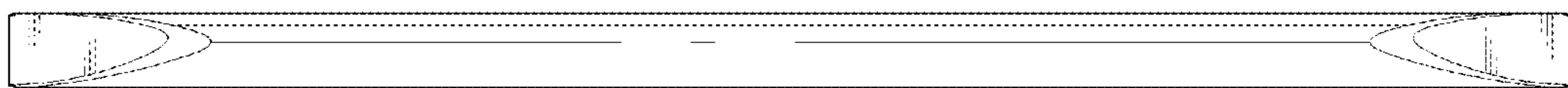

FIG. 4

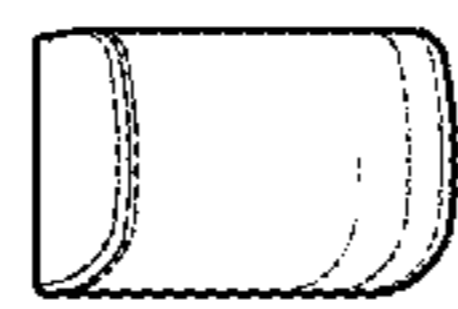

FIG. 5

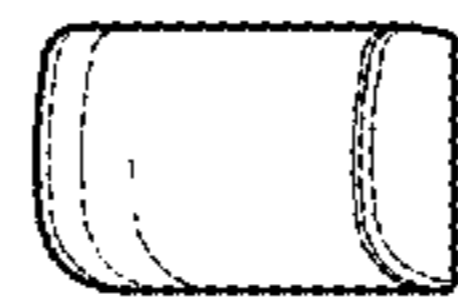

FIG. 6

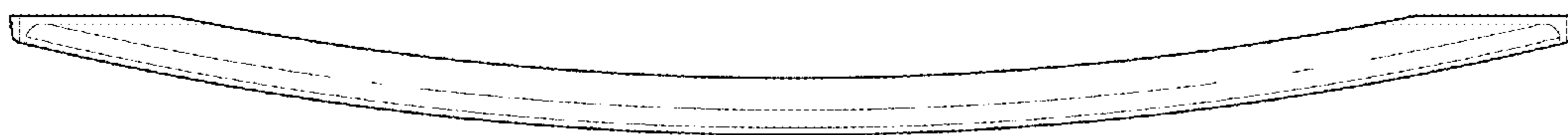

FIG. 7

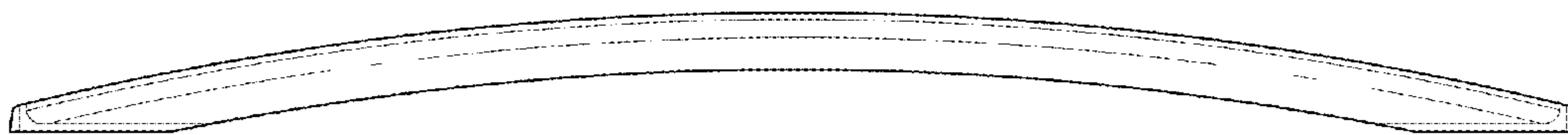

FIG. 8

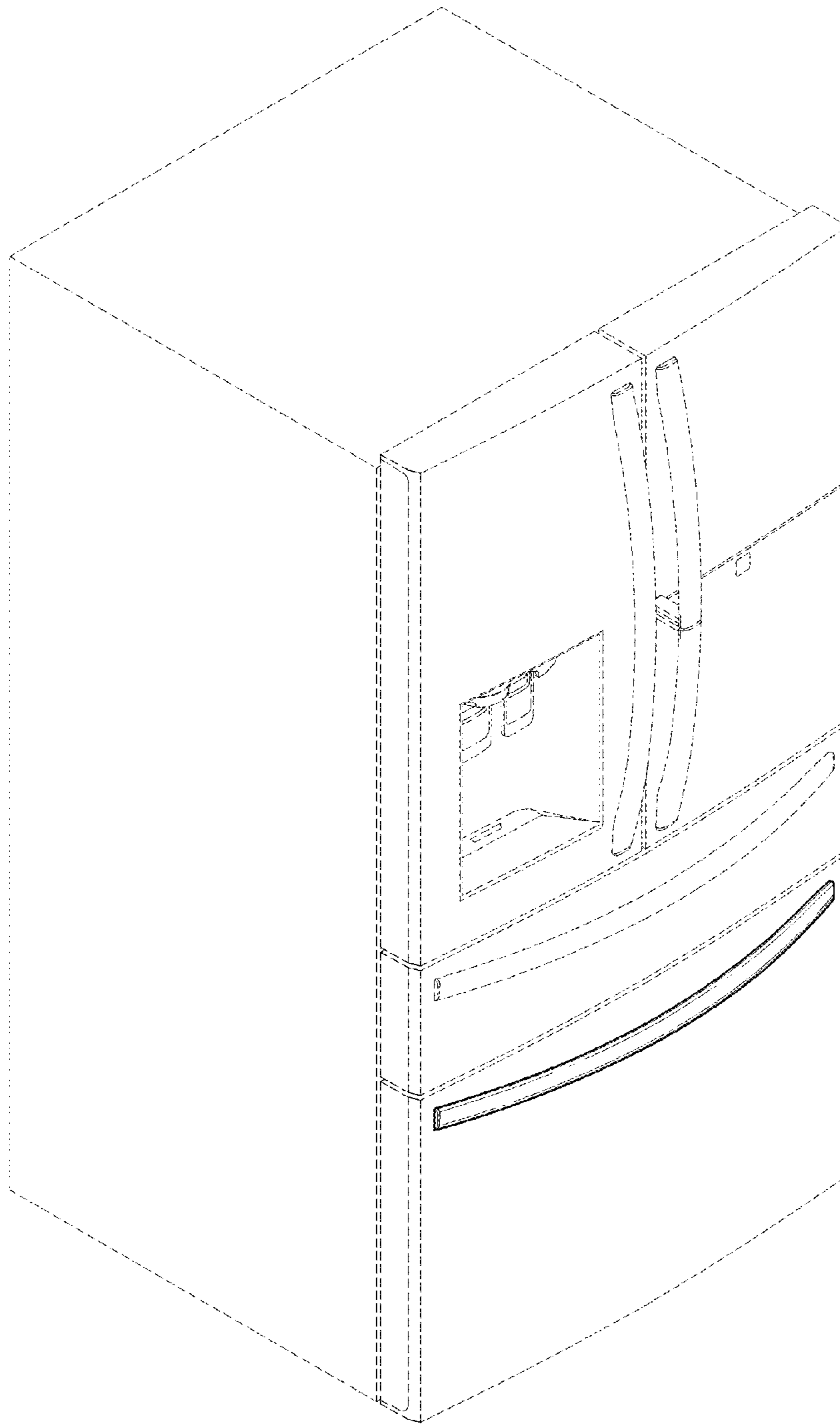

FIG. 9

