



US00D721987S

(12) **United States Design Patent**  
**Burgh**

(10) **Patent No.:** **US D721,987 S**  
(45) **Date of Patent:** **\*\* Feb. 3, 2015**

(54) **HEADER ORNAMENT**

(71) Applicant: **Stuart Edward Burgh**, Richmond, VA  
(US)

(72) Inventor: **Stuart Edward Burgh**, Richmond, VA  
(US)

(\*\*) Term: **14 Years**

(21) Appl. No.: **29/446,328**

(22) Filed: **Feb. 22, 2013**

(51) **LOC (10) Cl.** ..... **11-02**

(52) **U.S. Cl.**  
USPC ..... **D11/134**

(58) **Field of Classification Search**  
USPC ..... D11/131-134, 164; 428/542.2, 542.4,  
428/542.6; 434/295, 296, 297; D12/172,  
D12/197-201

See application file for complete search history.

(56) **References Cited**

**U.S. PATENT DOCUMENTS**

D119,636	S	*	3/1940	McPeak	.....	D11/134
D183,776	S	*	10/1958	Tickacek	.....	D11/134
3,319,922	A	*	5/1967	Christensen	.....	40/800
4,464,440	A	*	8/1984	Dotzman	.....	428/542.4
D287,344	S	*	12/1986	Hinnen	.....	D11/134
4,717,626	A	*	1/1988	Badger	.....	428/542.4
4,971,865	A	*	11/1990	Nowlan	.....	428/542.4
5,015,532	A	*	5/1991	Knight	.....	428/542.4
D355,390	S	*	2/1995	Culbertson	.....	D11/132
5,472,765	A	*	12/1995	Green	.....	428/99
D407,993	S	*	4/1999	Sprinkle	.....	D11/134
6,828,035	B1	*	12/2004	Goettl	.....	428/542.4

D608,686	S		1/2010	St. Ama	
D611,875	S	*	3/2010	Walker	..... D11/134
D639,703	S	*	6/2011	Walker	..... D11/134
D700,863	S	*	3/2014	Paragamian	..... D11/134

**OTHER PUBLICATIONS**

<http://fineartamerica.com/featured/deer-auto-antlers-8-point-truegearhead-team.html> Oct. 22, 2012.\*  
<https://www.kickstarter.com/projects/853956659/auto-antlers> Oct. 22, 2012.\*  
<http://www.lavenderbrocante.com/2011/01/urban-rustic-charm.html> Jan. 24, 2011.\*

\* cited by examiner

*Primary Examiner* — T. Chase Nelson  
*Assistant Examiner* — Michelle E Wilson  
(74) *Attorney, Agent, or Firm* — The Marbury Law Group, PLLC

(57) **CLAIM**

The ornamental design for a header ornament, as shown and described.

**DESCRIPTION**

FIG. 1 is a front/left side perspective view of the header ornament design.  
FIG. 2 is a front view of the header ornament design.  
FIG. 3 is a back view of the header ornament design.  
FIG. 4 is a left side view of the header ornament design.  
FIG. 5 is a right side view of the header ornament design.  
FIG. 6 is a top view of the header ornament design; and,  
FIG. 7 is a bottom view of the header ornament design.

**1 Claim, 6 Drawing Sheets**

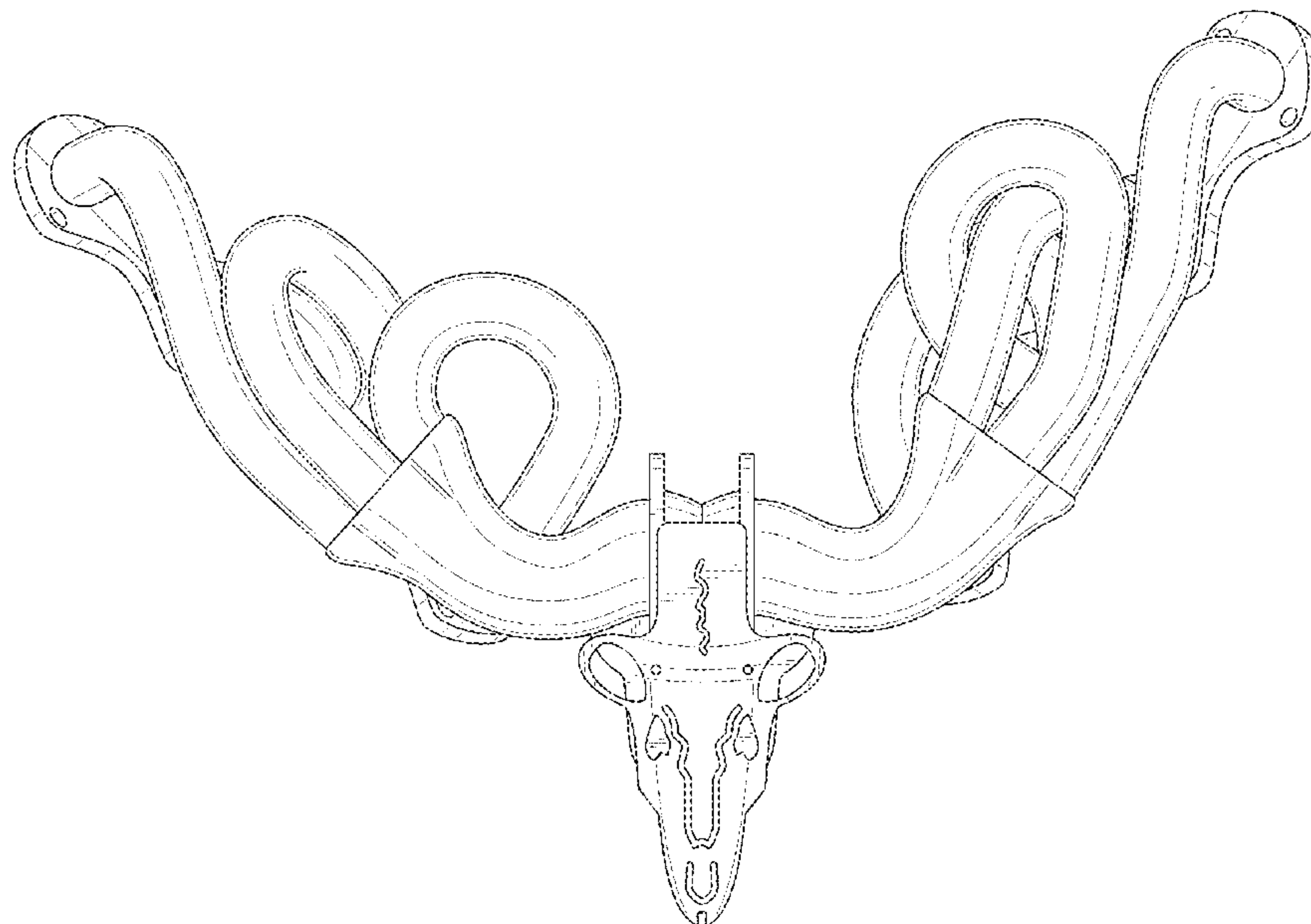



FIG. 1

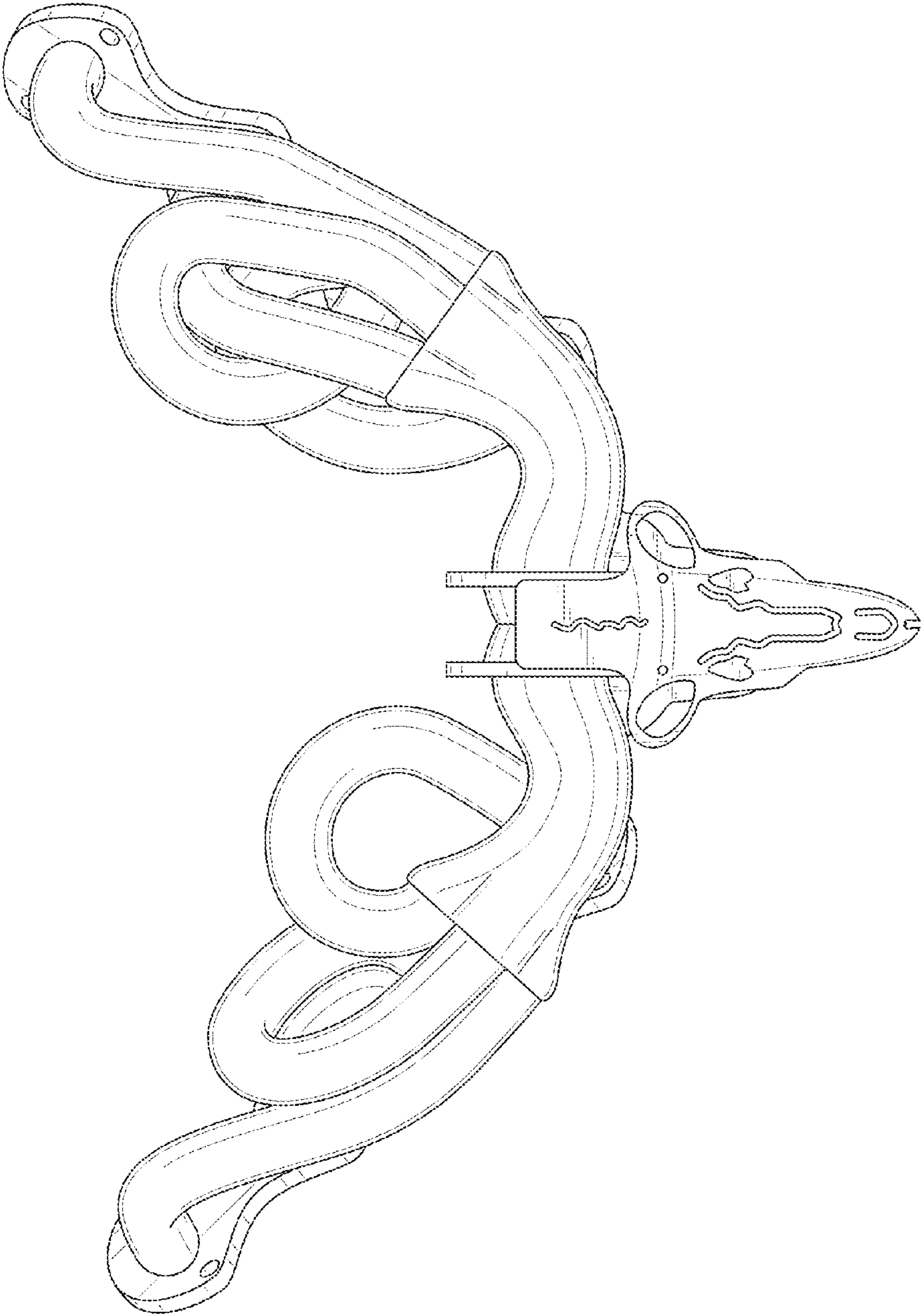

FIG. 2

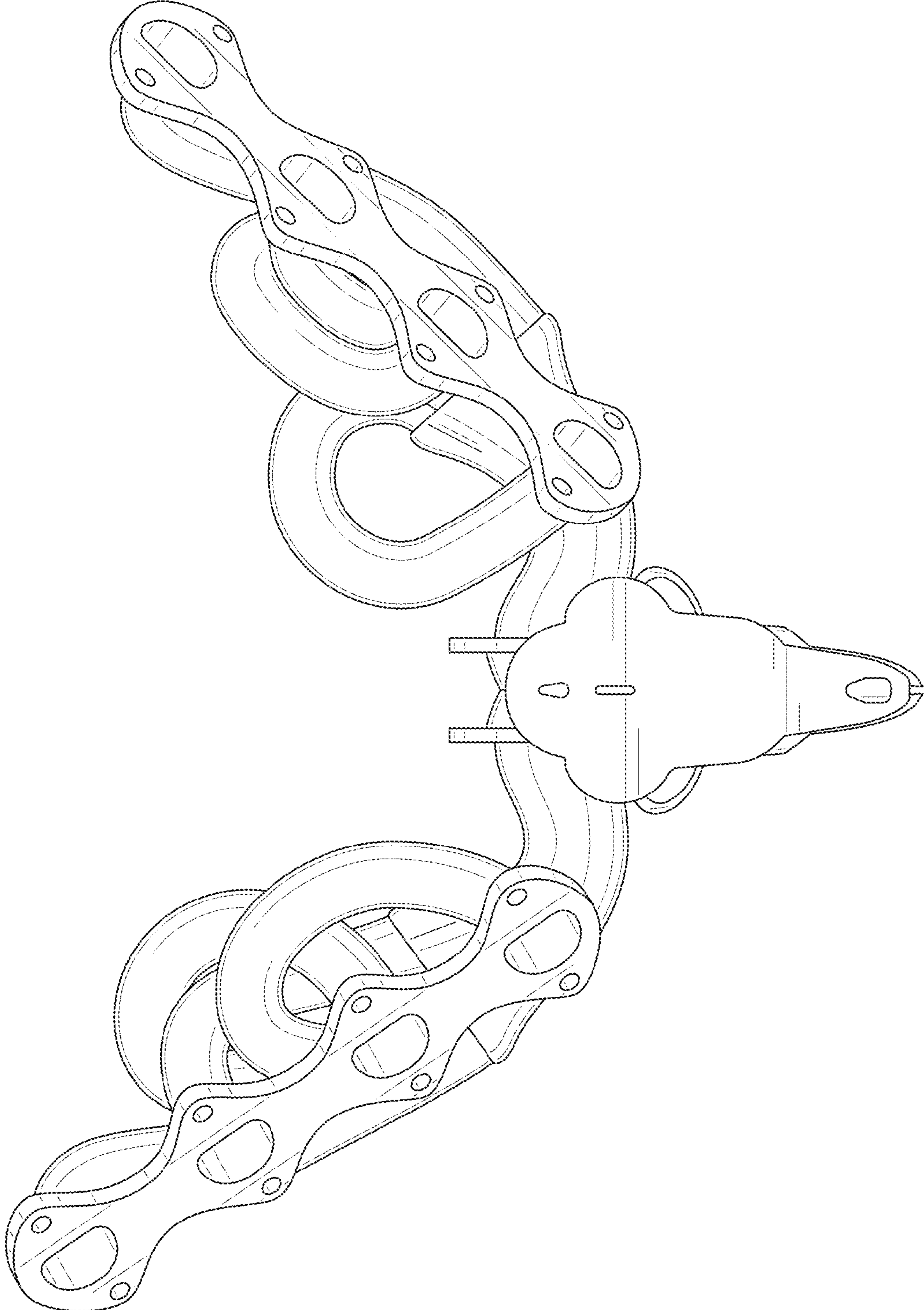

FIG. 3



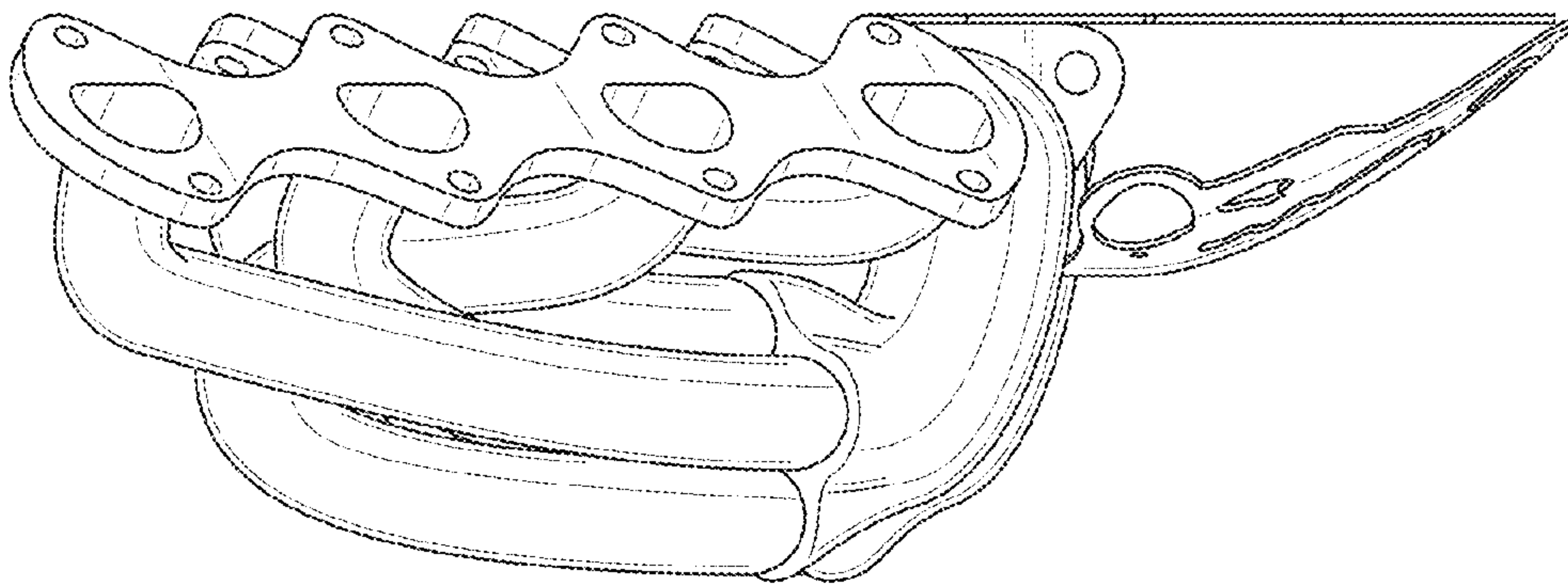

FIG. 5

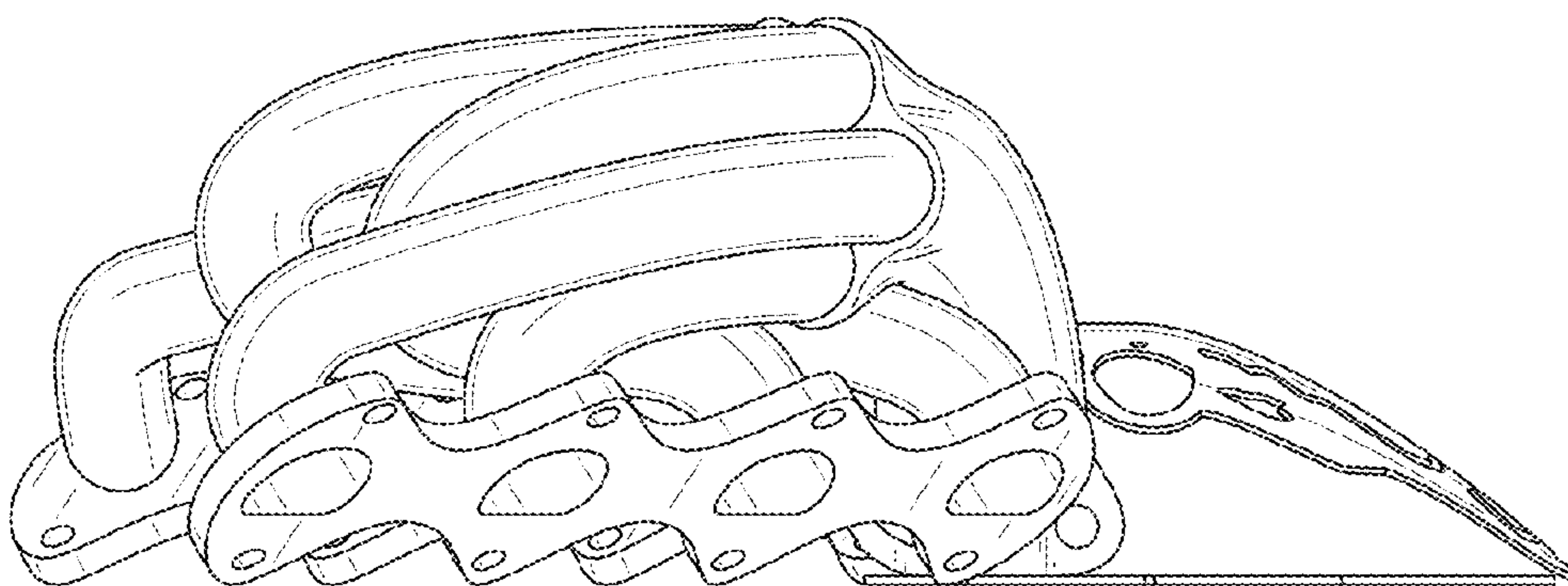

FIG. 4

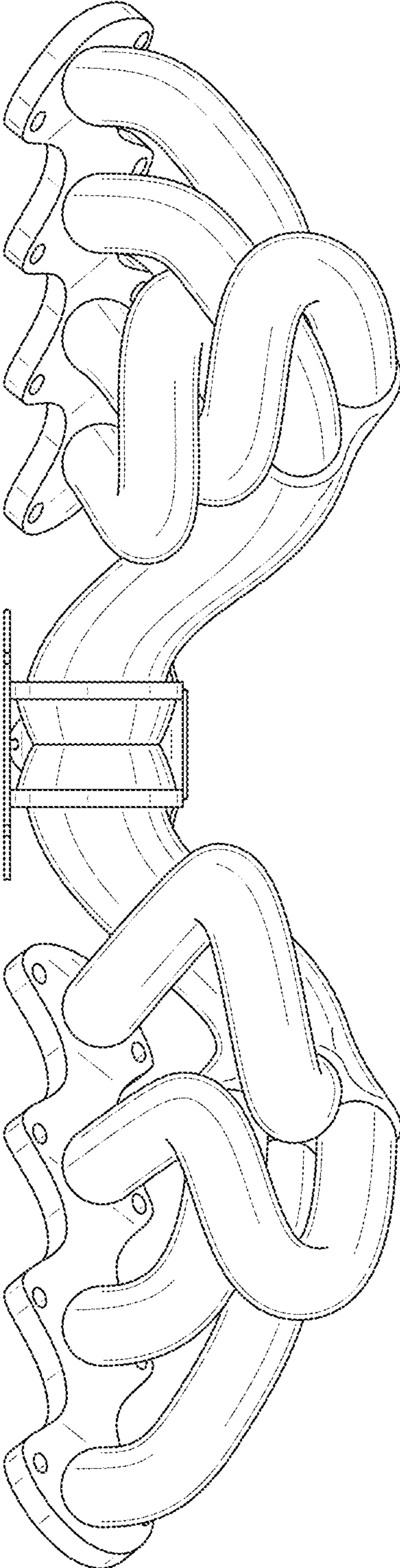

FIG. 6

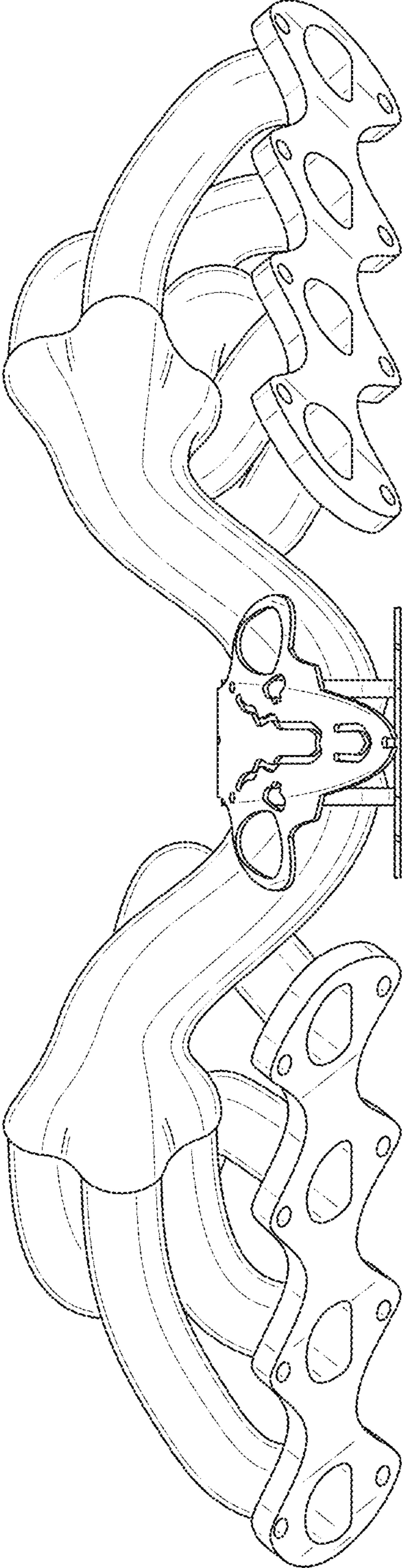

FIG. 7