



US00D721973S

(12) **United States Design Patent**
Das et al.

(10) **Patent No.:** **US D721,973 S**
(45) **Date of Patent:** **** Feb. 3, 2015**

- (54) **BOTTLE**
 - (75) Inventors: **Rajarshi Das**, Cary, IL (US); **Neil Enciso**, Palatine, IL (US); **Marc T. Wiescinski**, Chicago, IL (US)
 - (73) Assignee: **Tropicana Products, Inc.**, Bradenton, FL (US)
 - (**) Term: **14 Years**
 - (21) Appl. No.: **29/423,842**
 - (22) Filed: **Jun. 5, 2012**
 - (51) **LOC (10) Cl.** **09-01**
 - (52) **U.S. Cl.**
USPC **D9/542**
 - (58) **Field of Classification Search**
USPC D9/501, 516, 517, 538, 541–546,
D9/549–553, 555, 556, 566, 682–684;
220/660, 669, 643, 675; 215/200, 382,
215/384
- See application file for complete search history.

D149,617 S	5/1948	Conman	
D178,808 S	9/1956	Rosenak	
D192,942 S	5/1962	Du Pree	
3,323,668 A *	6/1967	Hills	215/10
D208,332 S	8/1967	Marona	
D212,463 S	10/1968	Vanderhyde	
3,403,804 A	10/1968	Colombo	
D212,672 S	11/1968	Weckman	
D213,038 S *	12/1968	Pettengill	D9/558
D213,767 S *	4/1969	Fuerst	D9/542
D216,459 S	1/1970	Viitanen	
D216,540 S	2/1970	Douglas	
D217,803 S	6/1970	Douglas	
D232,079 S	7/1974	Luedtke	
D233,828 S	12/1974	Leary	

(Continued)

FOREIGN PATENT DOCUMENTS

CA	106315	3/2006
GB	4000790	12/2006
GB	4005313	11/2007

Primary Examiner — Prabhakar Deshmukh
(74) *Attorney, Agent, or Firm* — Banner & Witcoff, Ltd.

(57) **CLAIM**
The ornamental design for a bottle, as shown and described.

DESCRIPTION

FIG. 1 is a top, front, right perspective view of a bottle showing our new design;
FIG. 2 is a front view thereof;
FIG. 3 is a right side view thereof;
FIG. 4 is a rear view thereof;
FIG. 5 is a left side view thereof;
FIG. 6 is a top view thereof; and,
FIG. 7 is a bottom view thereof.
The broken lines immediately adjacent to the shaded areas indicate unclaimed boundaries of the claimed design. The remaining broken lines indicate unclaimed portions of the claimed design. None of the broken lines form part of the claimed design.

1 Claim, 6 Drawing Sheets

(56) **References Cited**
U.S. PATENT DOCUMENTS

D29,673 S	11/1898	Nightingale
D51,893 S	3/1918	Temple
D56,983 S	1/1921	Lewis
D74,502 S	12/1926	Ginter
D84,239 S	5/1931	Furest
D86,280 S	2/1932	Smith
D86,816 S	4/1932	Von Till
D90,649 S	7/1933	Fleisch
D93,630 S	8/1933	Merolle
D97,465 S	3/1935	Conner
D103,987 S	4/1937	Ennever
D109,518 S	1/1938	Meier
D111,962 S	11/1938	Frank
D113,133 S	1/1939	De Nero
D115,430 S	6/1939	Street
D119,303 S	3/1940	Deletzke
D136,438 S	3/1943	Tatro

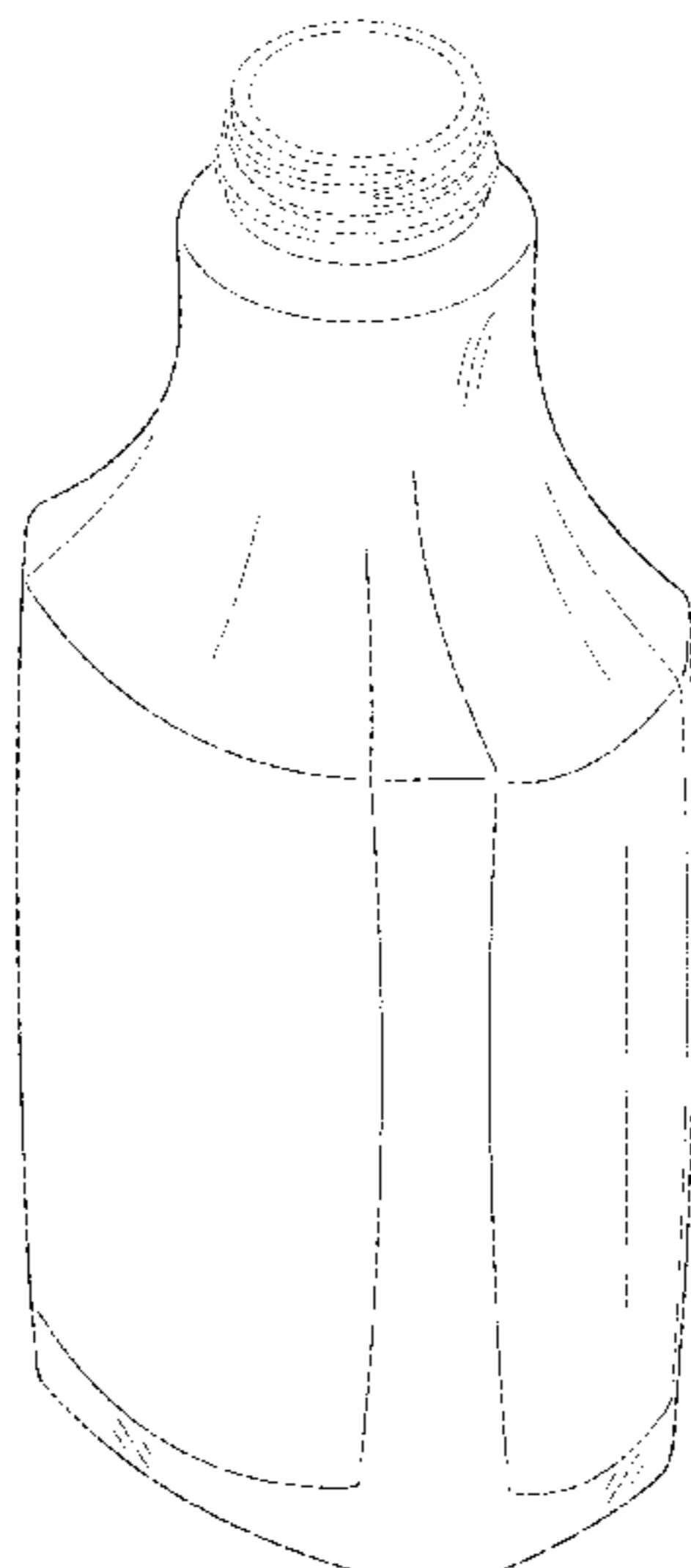

(56)

References Cited

U.S. PATENT DOCUMENTS

D236,587 S	9/1975	Kretz		D526,209 S	8/2006	Beard et al.	
D261,104 S	10/1981	Cohen		D526,210 S	8/2006	Beard et al.	
D263,562 S	3/1982	Cincala		D526,905 S	8/2006	Beard et al.	
D265,550 S	7/1982	Young et al.		D530,217 S	10/2006	Krause	
D292,380 S	10/1987	Smith		D531,042 S	10/2006	Venkataraman et al.	
D308,483 S *	6/1990	Weckman	D9/542	D533,408 S	12/2006	Jackson et al.	
4,993,565 A *	2/1991	Ota et al.	215/384	D534,808 S	1/2007	Haubert, III et al.	
D315,293 S	3/1991	Moglia		D535,189 S	1/2007	Pitman et al.	
5,037,684 A	8/1991	Dundas et al.		D536,257 S	2/2007	Weber	
D322,213 S	12/1991	Maginnis		D538,464 S	3/2007	Chen	
D325,347 S	4/1992	Doering		D539,158 S	3/2007	Miller et al.	
5,123,554 A *	6/1992	Arvidson et al.	215/12.2	D539,159 S	3/2007	Slat et al.	
D328,245 S	7/1992	Noble		D542,656 S	5/2007	Szczesniak	
D329,868 S	9/1992	Sakaguchi et al.		D542,669 S	5/2007	Arthur et al.	
5,261,544 A *	11/1993	Weaver, Jr.	215/384	D544,364 S	6/2007	Archeny et al.	
D343,793 S *	2/1994	Crawford	D9/529	D547,198 S	7/2007	Eaton et al.	
D346,548 S	5/1994	Maddox		D547,665 S	7/2007	Lepoitevin	
D352,461 S	11/1994	Flanagan et al.		D547,670 S	7/2007	Heisner	
D352,891 S	11/1994	Lalique		D548,092 S	8/2007	Klemm	
D356,506 S	3/1995	Kornick et al.		D555,500 S	11/2007	Johnston et al.	
D356,871 S	3/1995	Dunn		D560,508 S	1/2008	Lepoitevin	
D362,799 S *	10/1995	Noble	D9/717	D566,570 S	4/2008	Pence et al.	
D365,752 S	1/1996	Flanagan-Boos et al.		D567,098 S	4/2008	Sequeira	
D375,900 S	11/1996	DeVore		D568,754 S	5/2008	Sequeira	
D384,890 S *	10/1997	Goldman	D9/520	D569,261 S	5/2008	Sequeira	
D387,670 S	12/1997	Larkin		D573,031 S	7/2008	Hestehave	
D411,740 S	6/1999	Kim		D577,593 S	9/2008	Hestehave	
D413,265 S	8/1999	Hestehave et al.		D578,007 S	10/2008	Hestehave	
D413,511 S	9/1999	Guthrie et al.		D578,399 S	10/2008	Hestehave	
D422,493 S	4/2000	Clarke		D578,889 S	10/2008	Sadiq	
D425,793 S	5/2000	Walker		D579,338 S	10/2008	Hestehave	
D427,513 S	7/2000	Boisset		D583,236 S	12/2008	Fuchs	
D437,226 S	2/2001	Sadeghi et al.		D584,635 S	1/2009	Montgomery	
D442,089 S	5/2001	Sadeghi et al.		D588,463 S	3/2009	Forget	
D443,513 S	6/2001	Goettner		D594,331 S	6/2009	Herb et al.	
D447,698 S	9/2001	Kaufman		D594,748 S	6/2009	Herb et al.	
D452,650 S	1/2002	Moore et al.		D596,488 S	7/2009	Chupak	
D456,272 S	4/2002	Sadeghi et al.		D596,942 S	7/2009	Britto	
D457,437 S	5/2002	Sadeghi et al.		D606,401 S	12/2009	Kamath et al.	
D458,145 S	6/2002	Sadeghi et al.		D608,201 S	1/2010	Fuchs	
D458,146 S	6/2002	Sadeghi et al.		D610,017 S	2/2010	Howell	
D458,147 S	6/2002	Sadeghi et al.		D610,913 S	3/2010	Lesueur	
D458,148 S	6/2002	Sadeghi et al.		D611,356 S	3/2010	Kaminski et al.	
D460,695 S	7/2002	Sadeghi et al.		D612,256 S	3/2010	Wurster et al.	
D463,281 S	9/2002	Druitt		D612,257 S	3/2010	Wurster et al.	
D463,287 S	9/2002	Moore et al.		D613,162 S	4/2010	Druitt	
D465,730 S	11/2002	Druitt		D613,175 S	4/2010	Delbon	
D468,213 S	1/2003	Moore et al.		D616,745 S	6/2010	Stull et al.	
D477,066 S	7/2003	Lonczak et al.		D616,746 S	6/2010	Stull et al.	
D480,315 S	10/2003	Sadeghi et al.		D616,747 S	6/2010	Stull et al.	
D480,644 S	10/2003	Druitt		D617,191 S	6/2010	Stull et al.	
D483,675 S	12/2003	Lindsay et al.		D617,203 S	6/2010	Yourist	
D488,060 S	4/2004	Yourist		D619,014 S	7/2010	Jensen et al.	
D489,991 S	5/2004	Deubel et al.		D623,070 S	9/2010	Jamison et al.	
D491,068 S	6/2004	Heliste et al.		D623,528 S	9/2010	Brandt	
6,783,014 B2	8/2004	Luker		D623,530 S	9/2010	Ungrady	
D496,282 S *	9/2004	Heliste et al.	D9/542	D623,531 S	9/2010	Ungrady et al.	
D500,677 S	1/2005	Druitt		D624,422 S	9/2010	Caldwell et al.	
D510,026 S	9/2005	Nelson et al.		D624,823 S	10/2010	Brown	
D510,523 S	10/2005	Pitman et al.		D629,305 S	12/2010	Arnell et al.	
6,997,336 B2	2/2006	Yourist et al.		D631,349 S	1/2011	Arnell et al.	
D525,141 S	7/2006	Beard et al.		D643,291 S	8/2011	Haskins	
D525,529 S	7/2006	Oguchi et al.		D655,198 S	3/2012	Finlay et al.	
				D671,416 S *	11/2012	Nukuto et al.	D9/542
				2005/0006334 A1	1/2005	Luker	

* cited by examiner

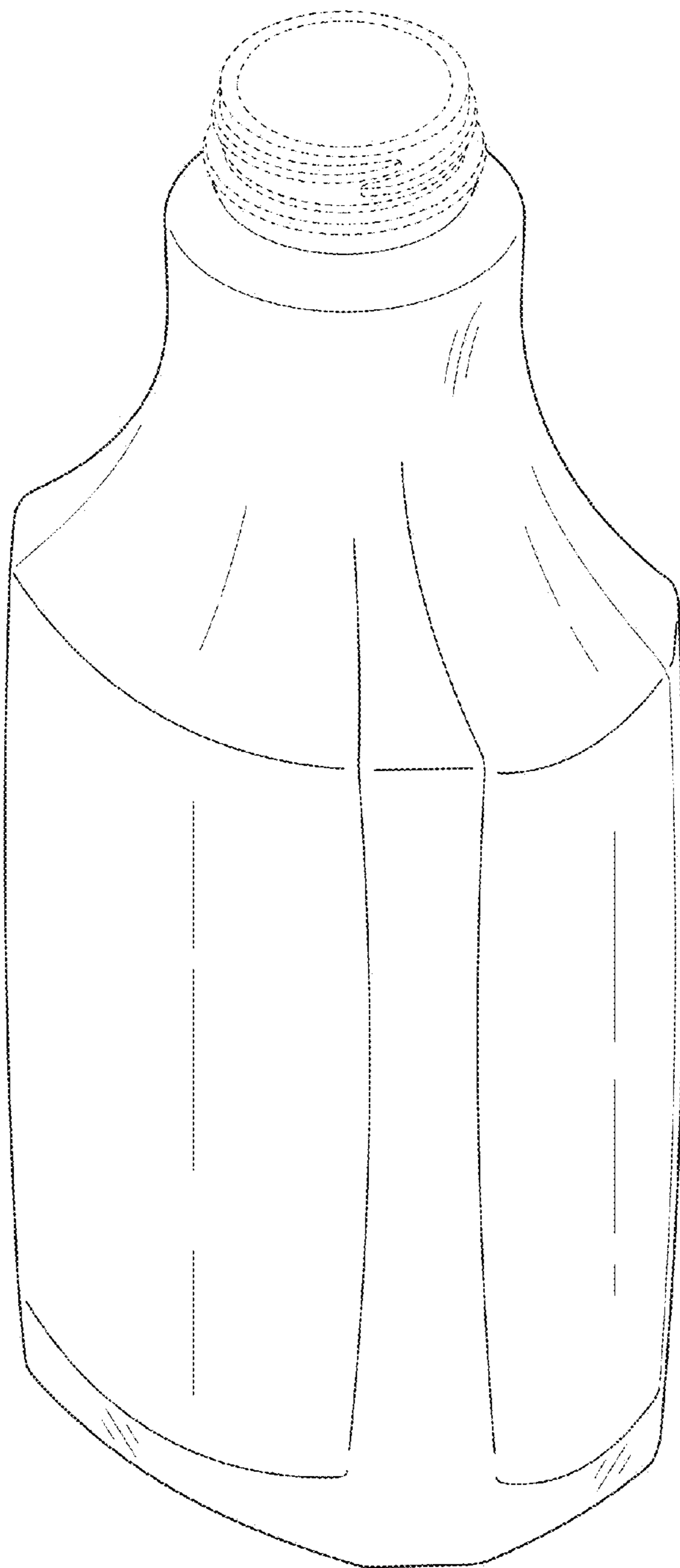

FIG. 1

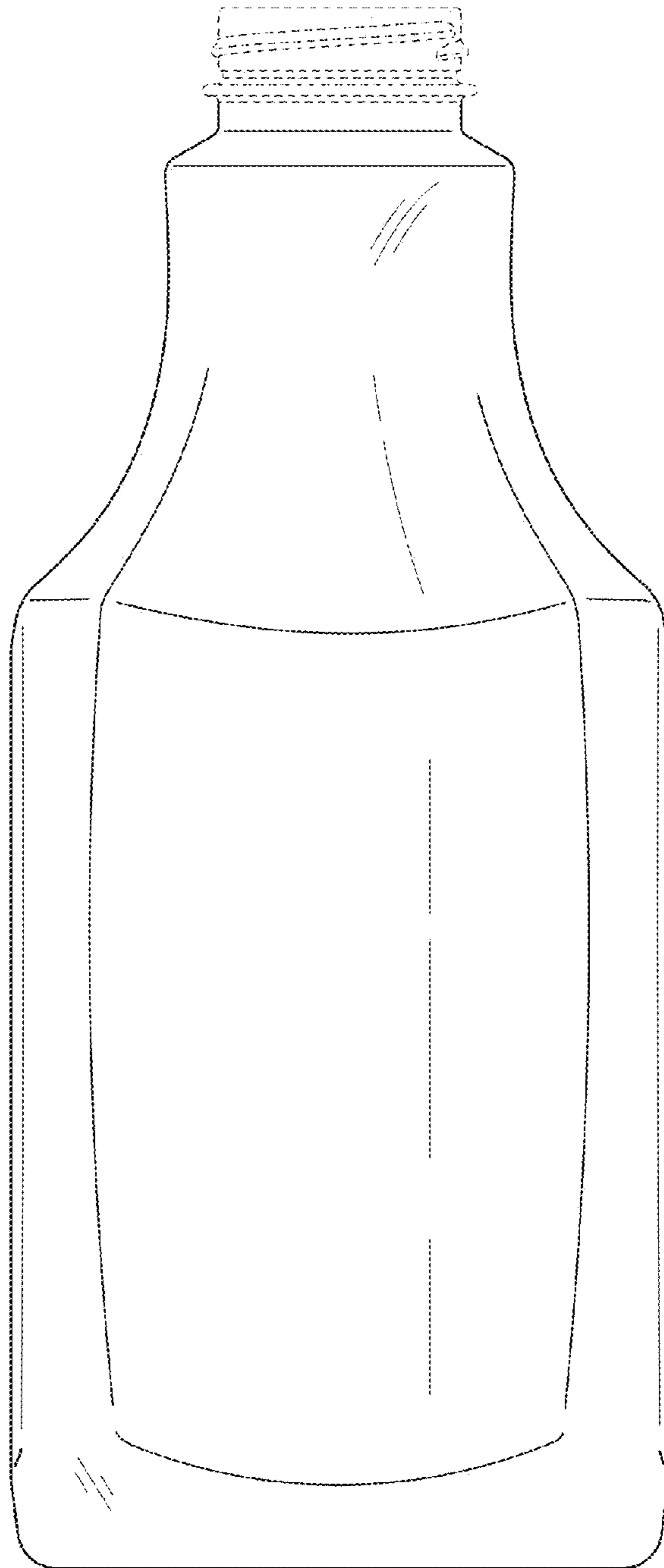

FIG. 2

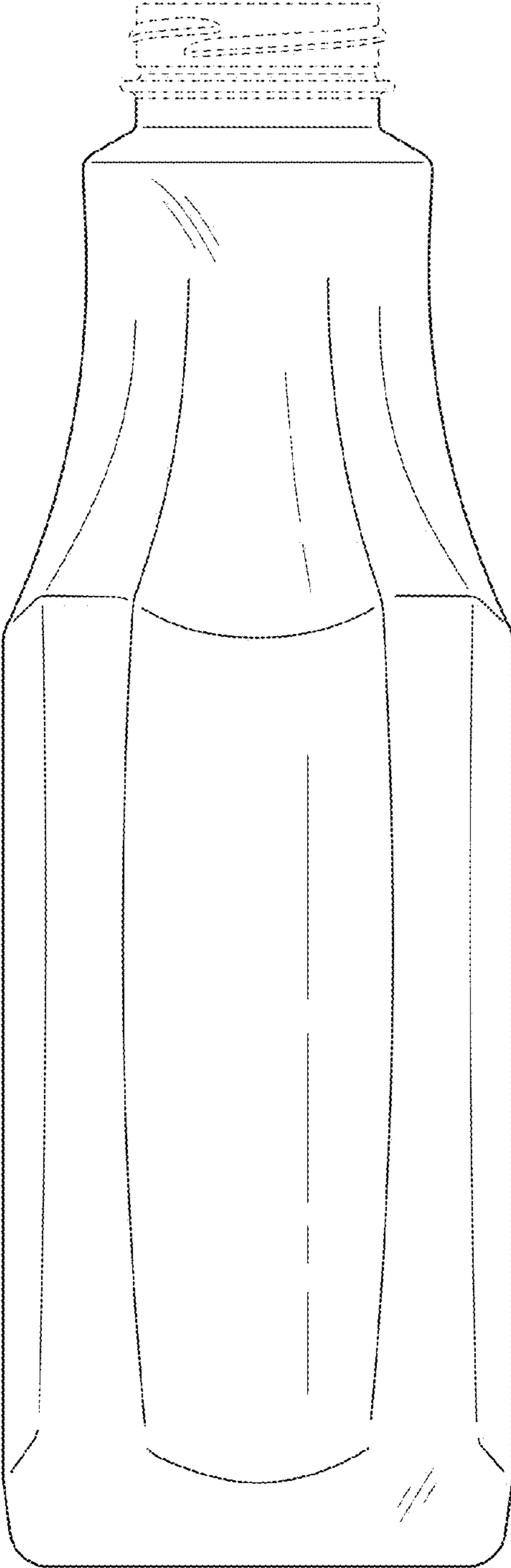

FIG. 3

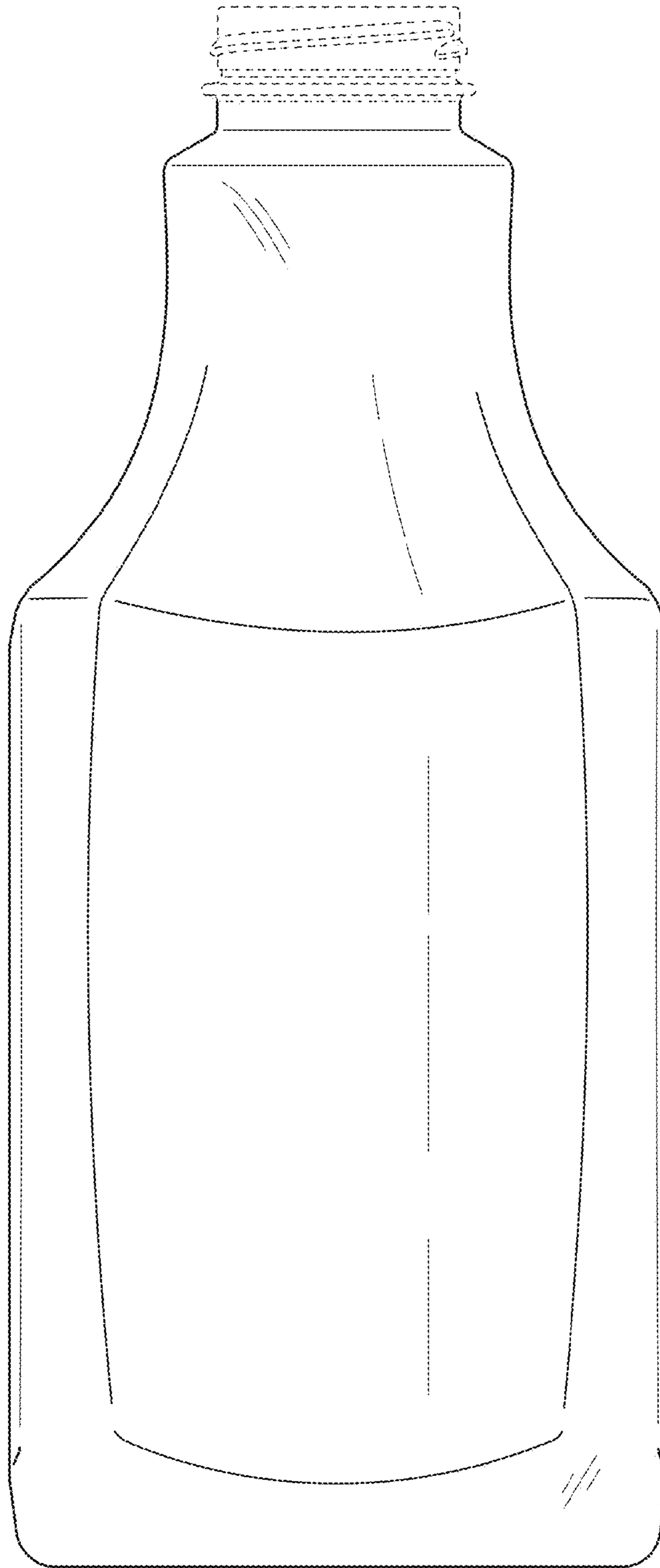

FIG. 4

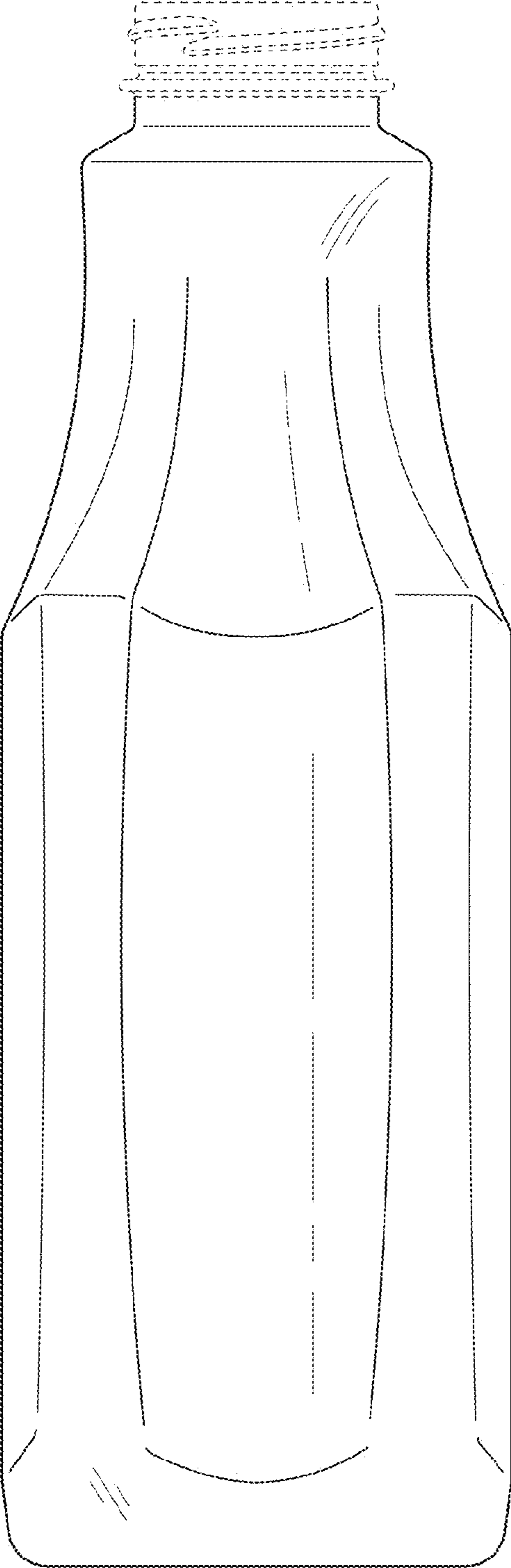

FIG. 5

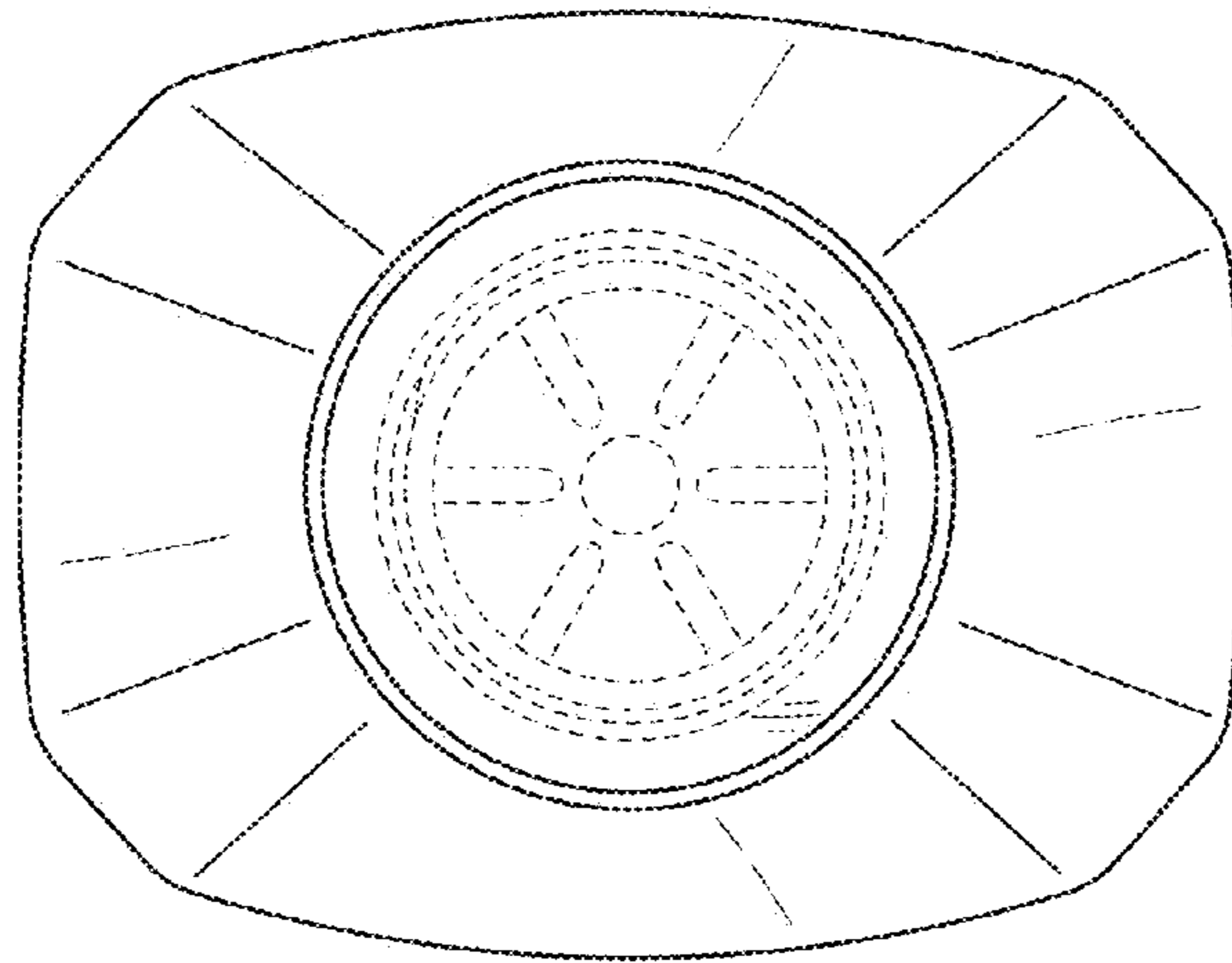

FIG. 6

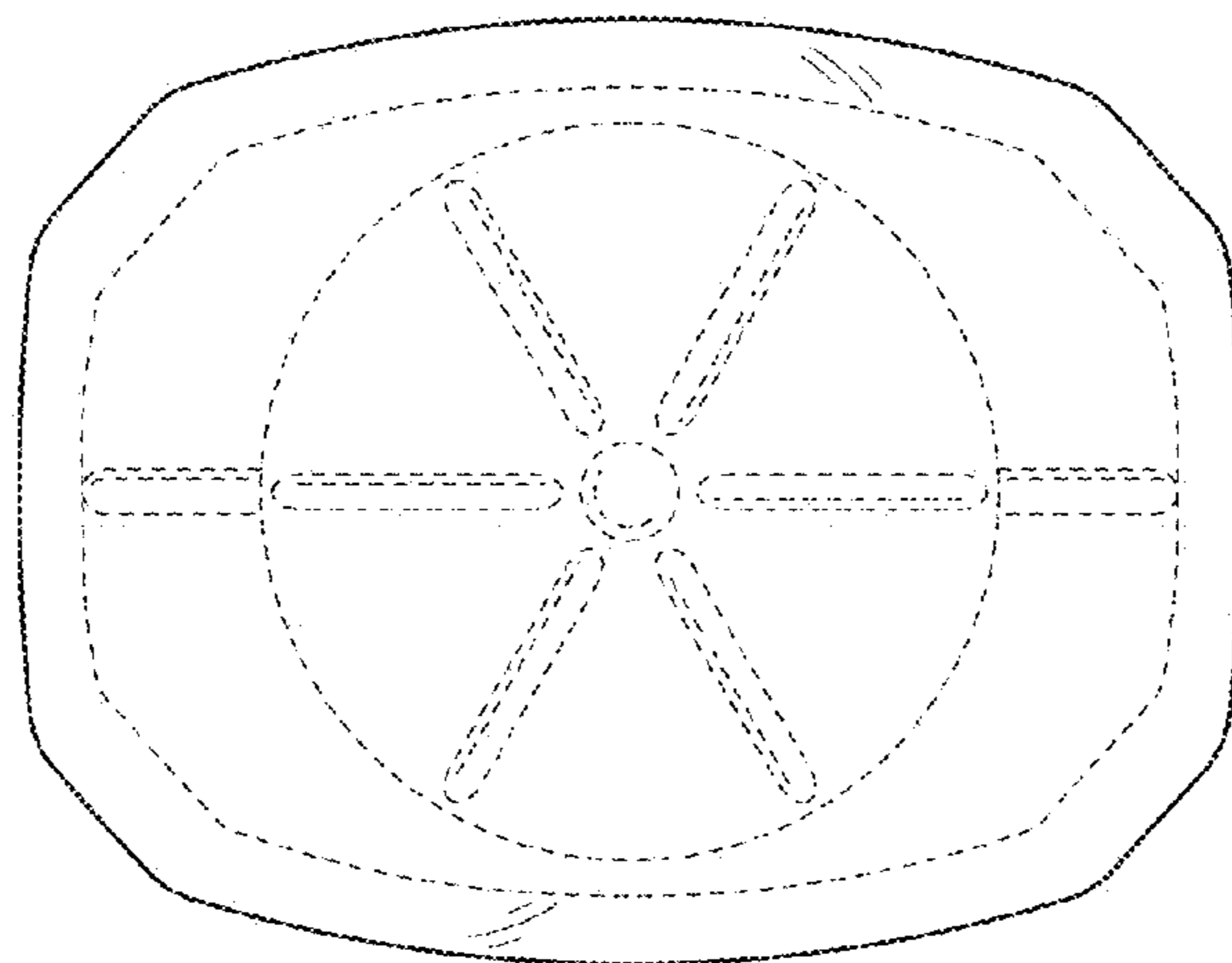

FIG. 7