



US00D721858S

(12) **United States Design Patent**
Haigh

(10) **Patent No.:** **US D721,858 S**
(45) **Date of Patent:** **** Jan. 27, 2015**

(54) **MAGNETIC WRIST RESTRAINT AND TETHER**

(76) Inventor: **Andrew J. Haigh**, Massapequa Park, NY (US)

(**) Term: **14 Years**

(21) Appl. No.: **29/431,952**

(22) Filed: **Sep. 12, 2012**

(51) **LOC (10) Cl.** **08-07**

(52) **U.S. Cl.**
USPC **D29/120.2**

(58) **Field of Classification Search**
USPC D29/120.1, 120.2, 113; 2/16, 17, 170;
24/16 PB; 70/14-19; 119/770; 128/869,
128/878

See application file for complete search history.

(56) **References Cited**

U.S. PATENT DOCUMENTS

1,883,502	A	10/1932	Blake	
4,226,036	A *	10/1980	Krug	40/633
5,221,393	A *	6/1993	Heutschi	156/191
5,349,725	A	9/1994	Levy	
D373,446	S	9/1996	Kim et al.	
D375,186	S *	11/1996	Kim	D29/101.3
5,642,739	A *	7/1997	Fareed	128/881
6,958,048	B2 *	10/2005	Bonutti	602/4
7,595,733	B2 *	9/2009	Spagna	340/572.8
8,196,588	B1 *	6/2012	Krenzel	128/869
2003/0229974	A1	12/2003	Zemer et al.	
2007/0084255	A1	4/2007	Otto	

* cited by examiner

Primary Examiner — Randall Gholson

(74) *Attorney, Agent, or Firm* — Robert C. Montgomery;
Montgomery Patent & Design

(57) **CLAIM**

The ornamental design for a magnetic wrist restraint and tether, as shown and described.

DESCRIPTION

FIG. 1 is a perspective view of a magnetic wrist restraint depicted in a magnetically attached state, showing my new design;

FIG. 2 is an exploded perspective view of the magnetic wrist restraint depicted in a detached state;

FIG. 3 is perspective view of a magnetic wrist restraint in a flattened position;

FIG. 4 is an enlarged front view of the magnetic wrist restraint of FIG. 3;

FIG. 5 is an enlarged rear view of the magnetic wrist restraint of FIG. 3;

FIG. 6 is a left side view of the magnetic wrist restraint of FIG. 3 with a right side view being a mirror image;

FIG. 7 is a top view of the magnetic wrist restraint of FIG. 3;

FIG. 8 is a bottom view of the magnetic wrist restraint of FIG. 3;

FIG. 9 is a perspective view of the magnetic wrist restraint and tether depicted in a magnetically attached state;

FIG. 10 is an exploded perspective view of the magnetic wrist restraint and tether depicted in a detached state;

FIG. 11 is a front view of a tether of FIG. 10;

FIG. 12 is a rear view of the tether of FIG. 10;

FIG. 13 is a left side view of the tether of FIG. 10;

FIG. 14 is a right side view of the tether of FIG. 10; and,

FIG. 15 is a top view of the tether of FIG. 10 with a bottom view being a mirror image.

The magnetic wrist restraint and tether are shown separately and together for ease of illustration.

The broken line showing of an additional magnetic wrist restraint shown in FIG. 1 and of fasteners in FIGS. 1 through 10 is for the purpose of illustrating environment and forms no part of the claimed design.

1 Claim, 13 Drawing Sheets

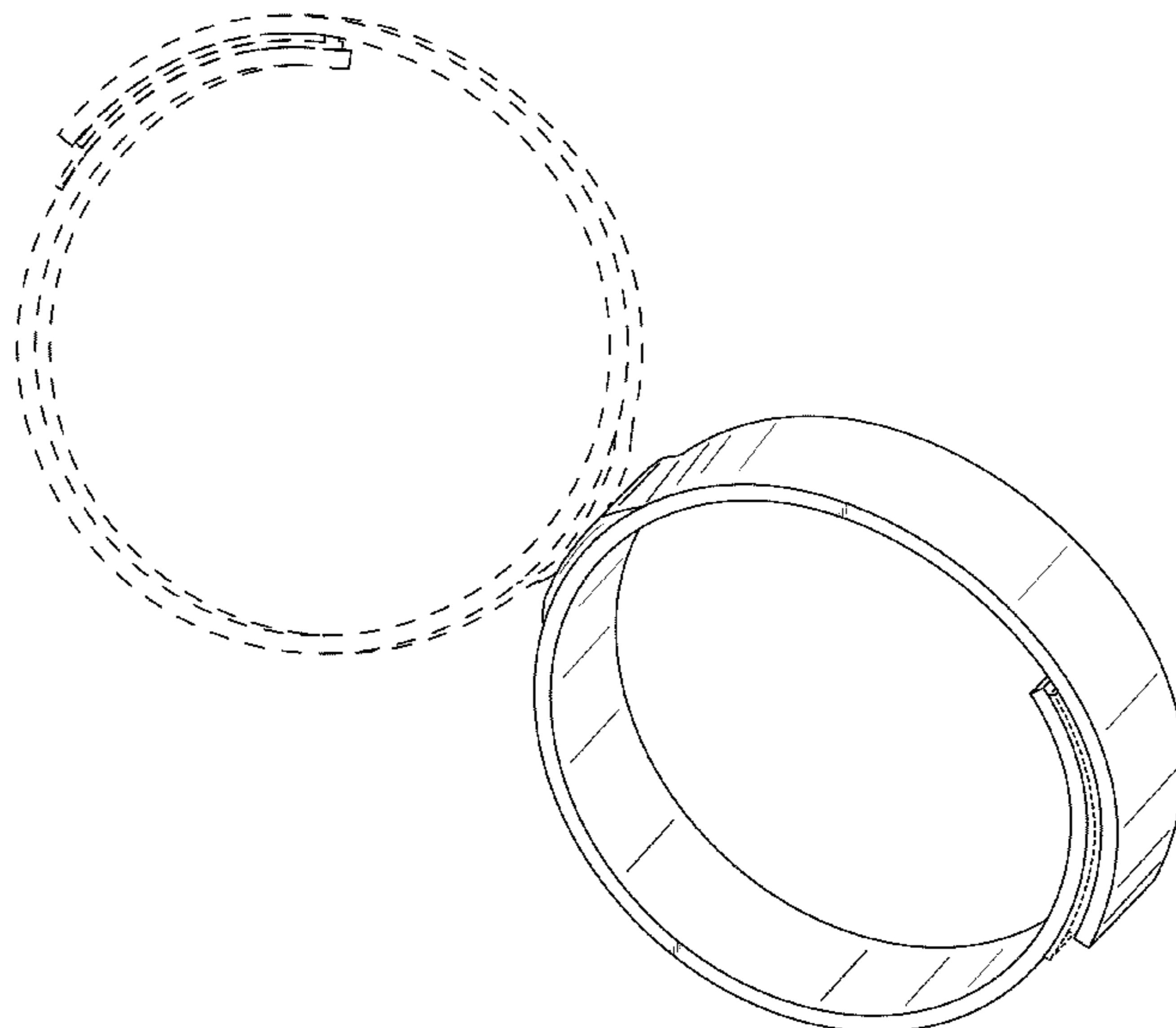

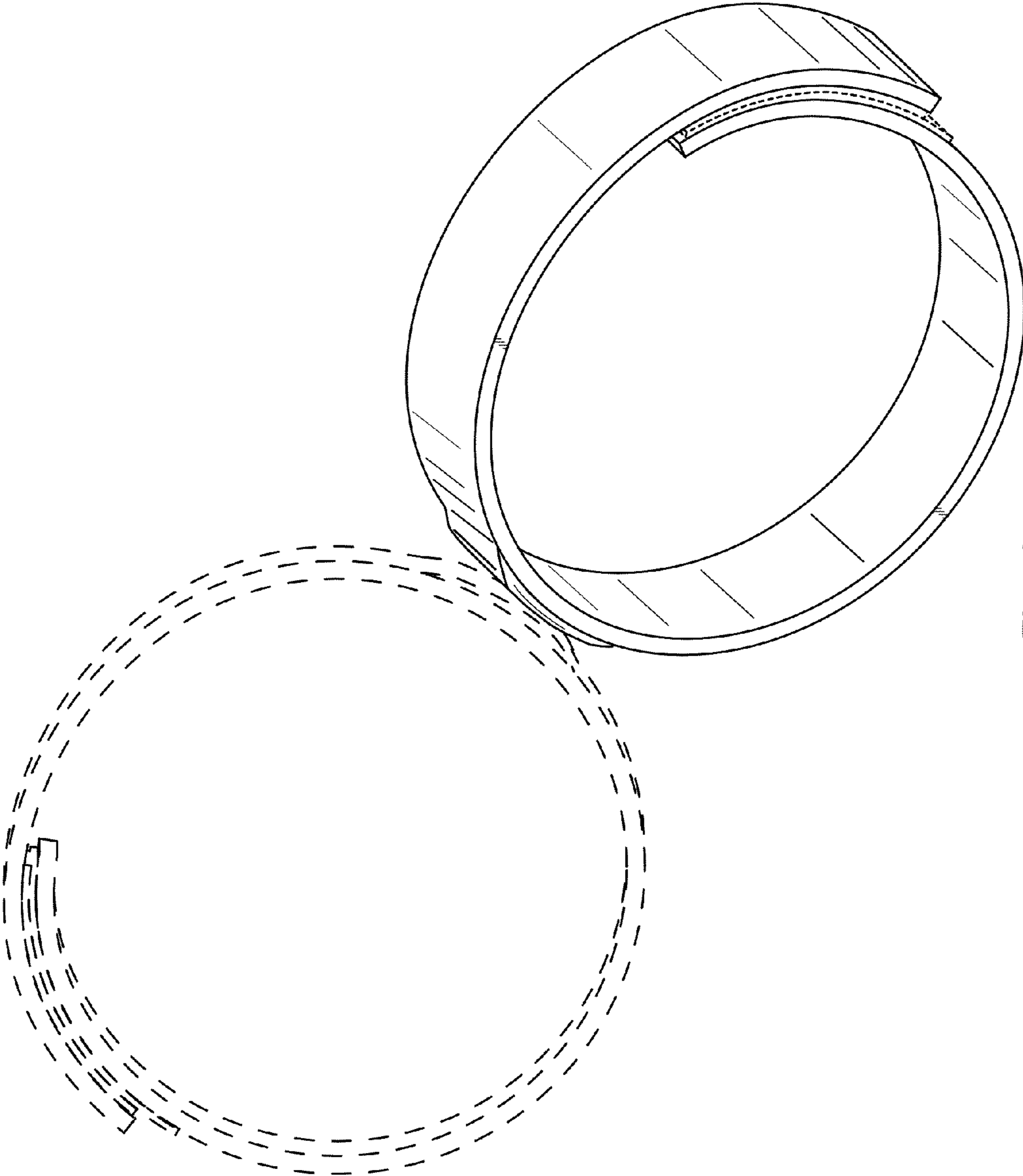

Fig. 1

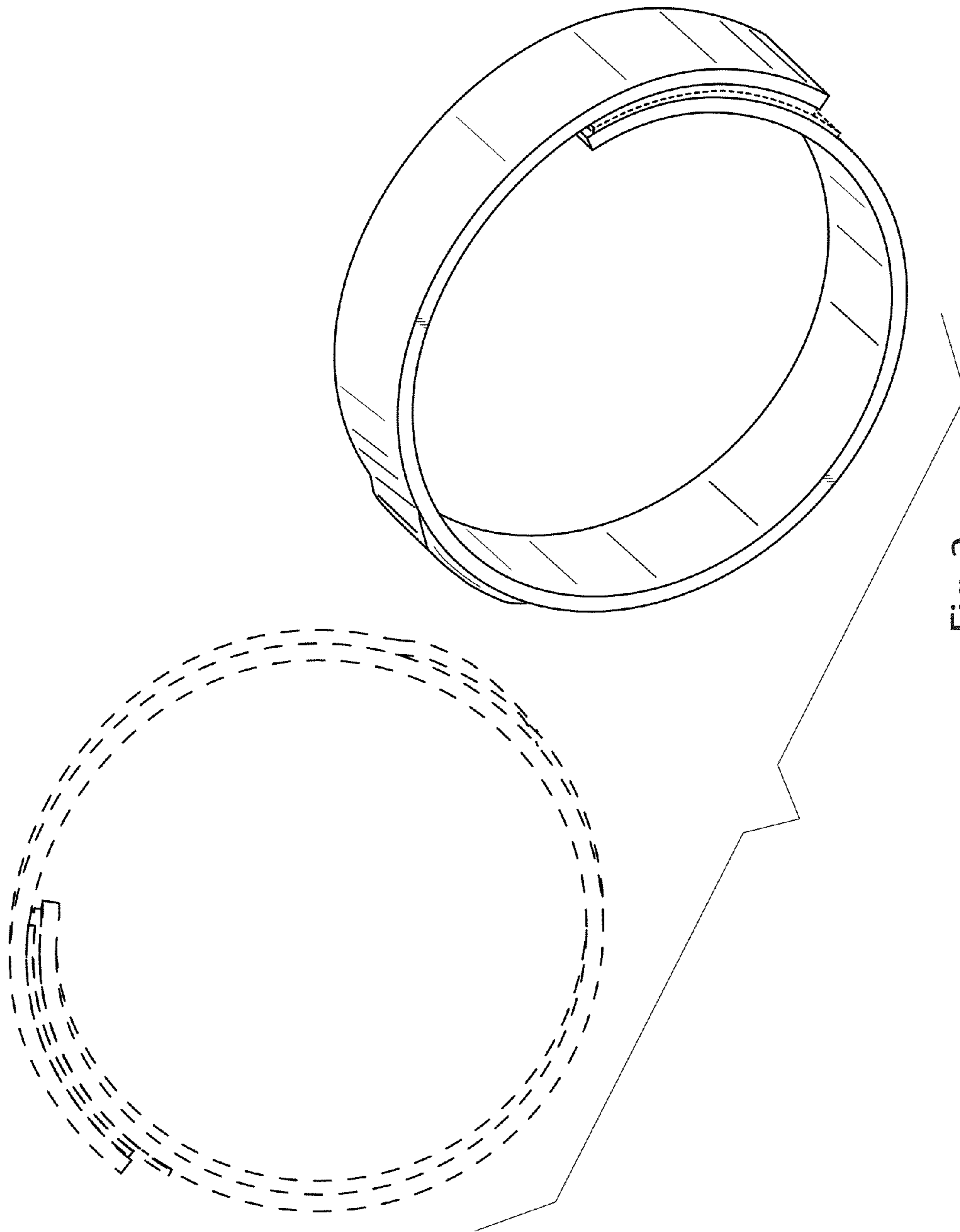

Fig. 2

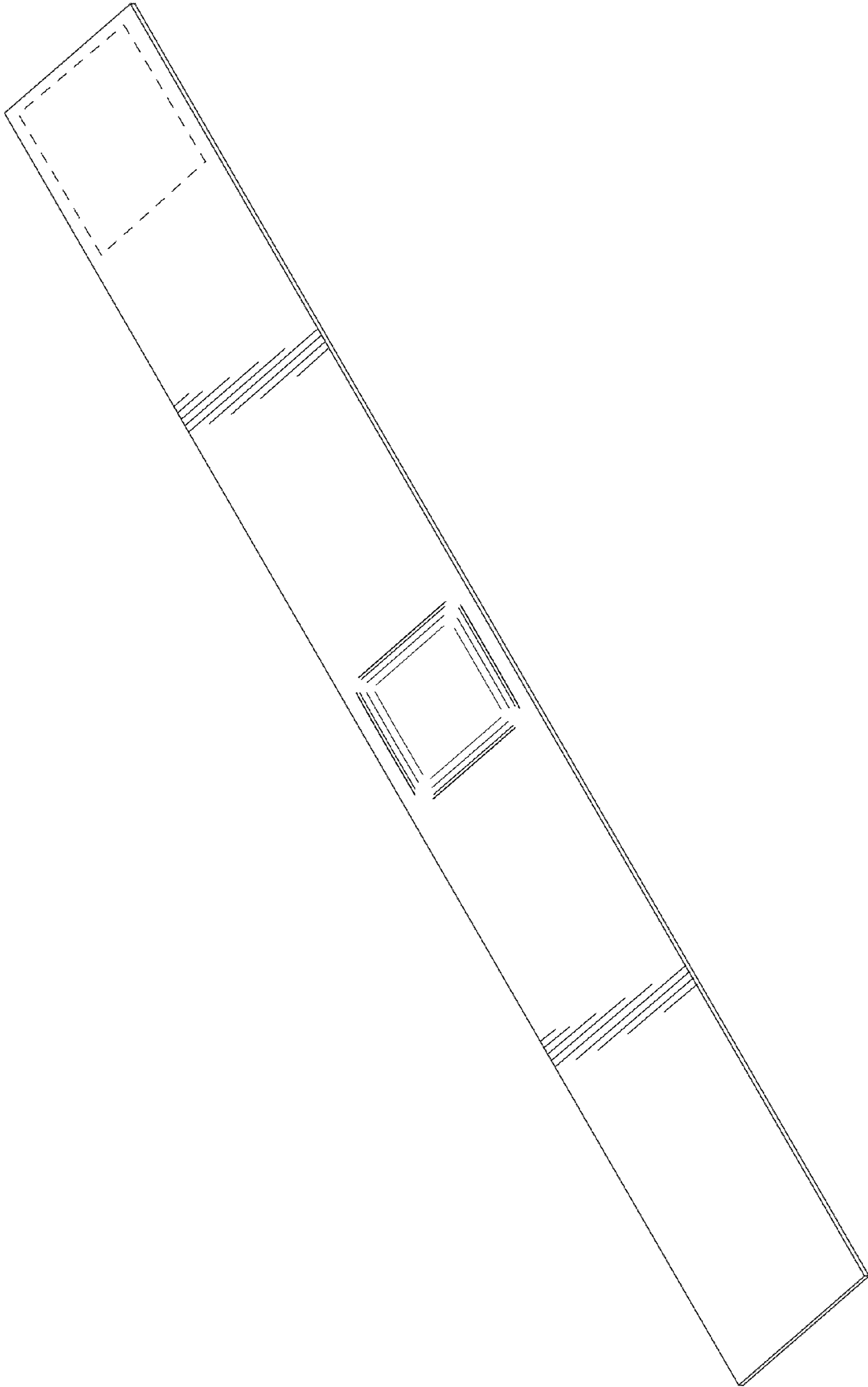

Fig. 3

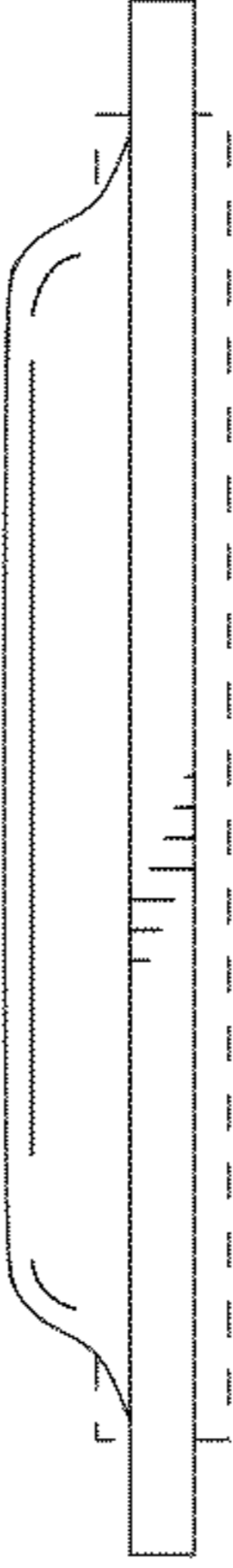

Fig. 4

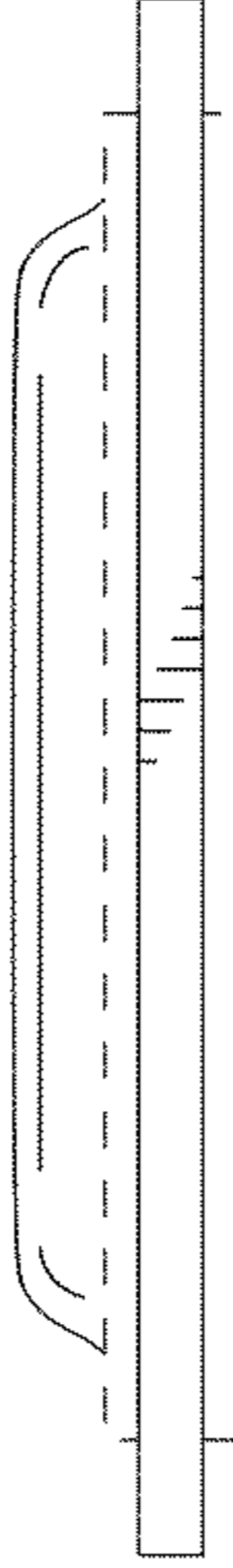

Fig. 5

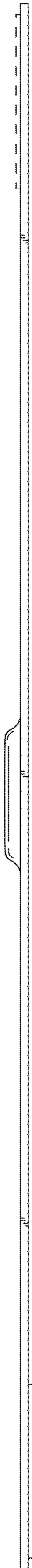

Fig. 6

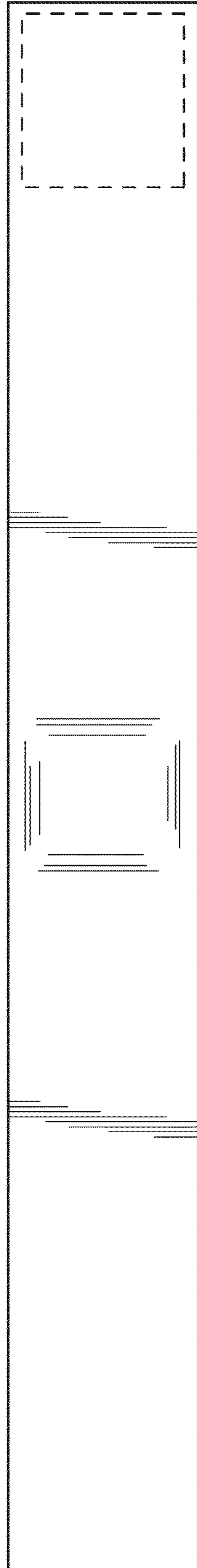

Fig. 7

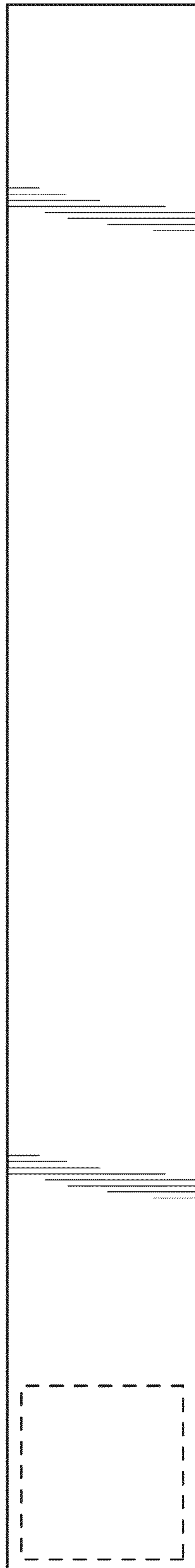

Fig. 8

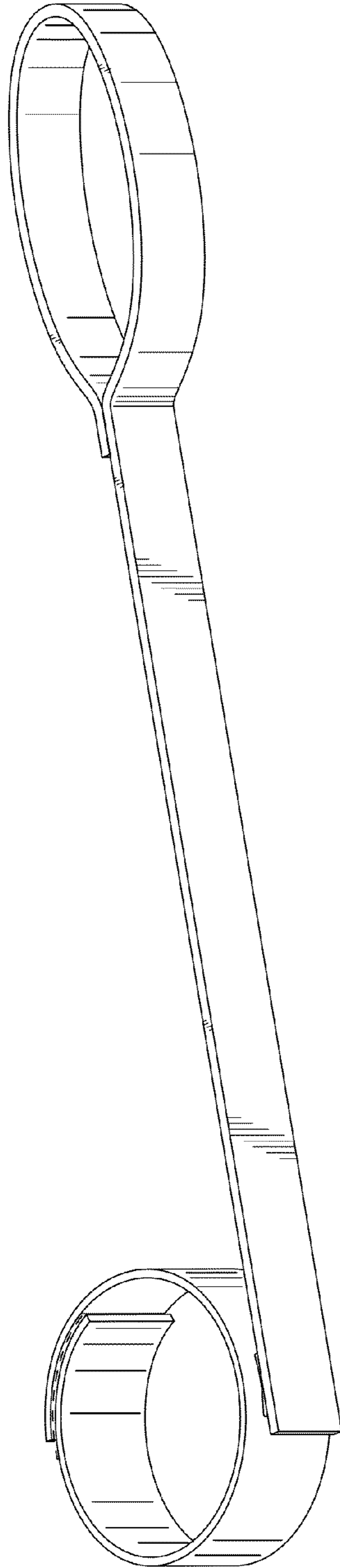

Fig. 9

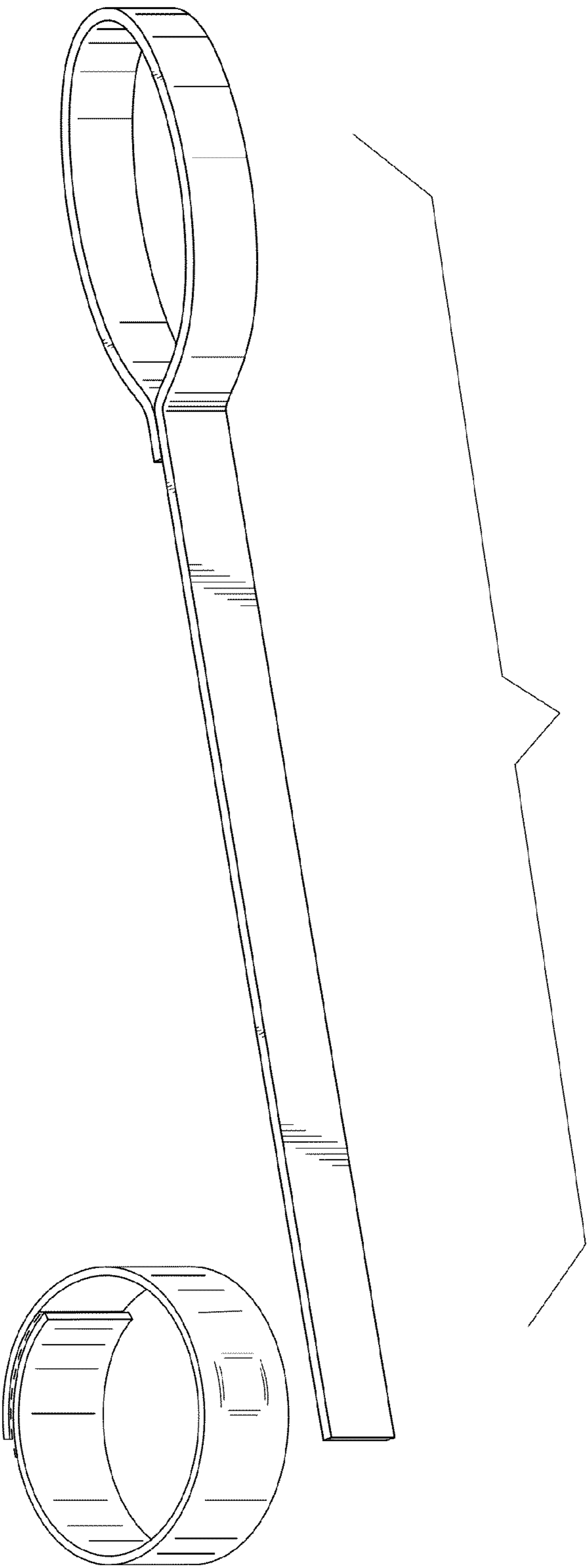

Fig. 10

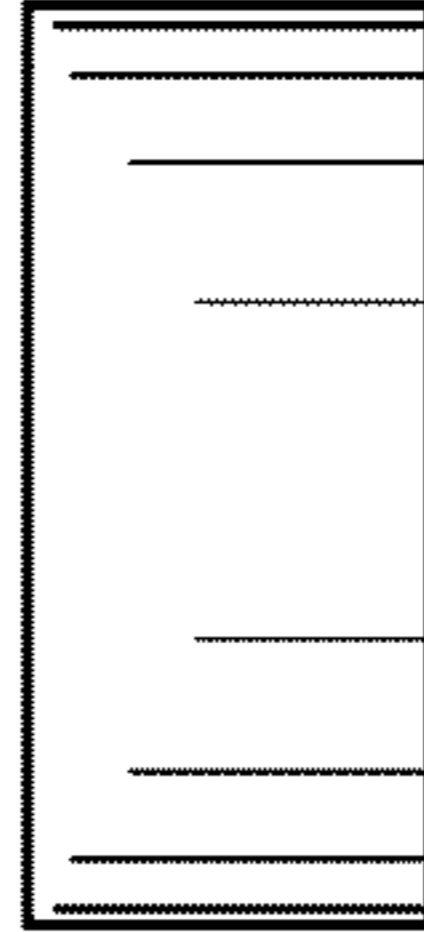

Fig. 12

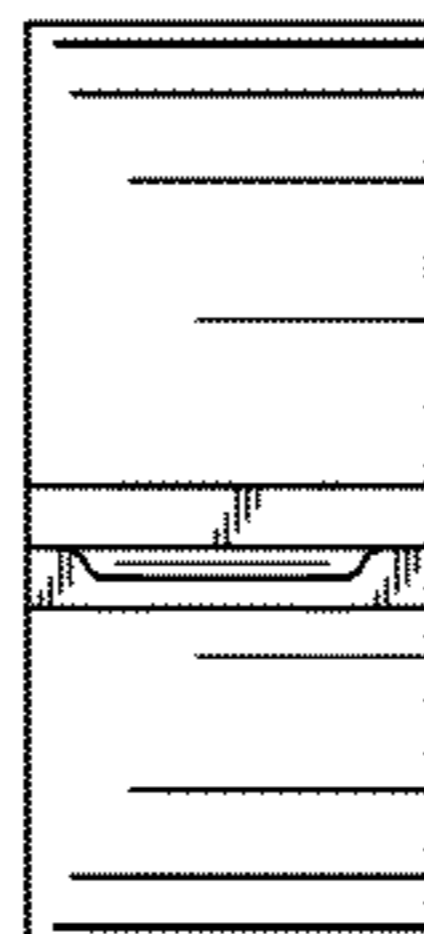

Fig. 11

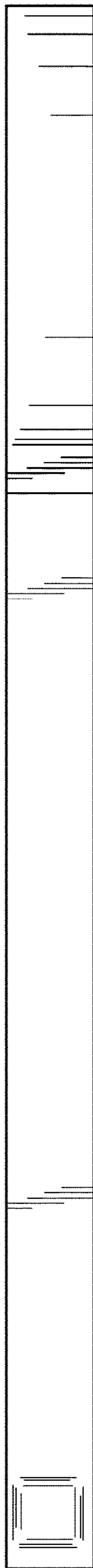

Fig. 13

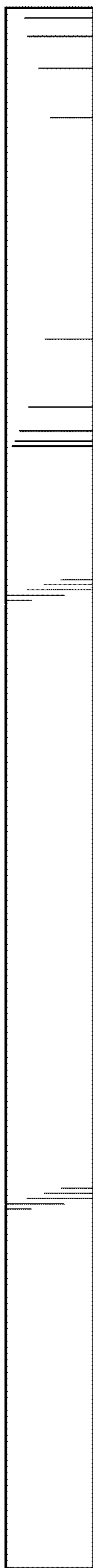

Fig. 14

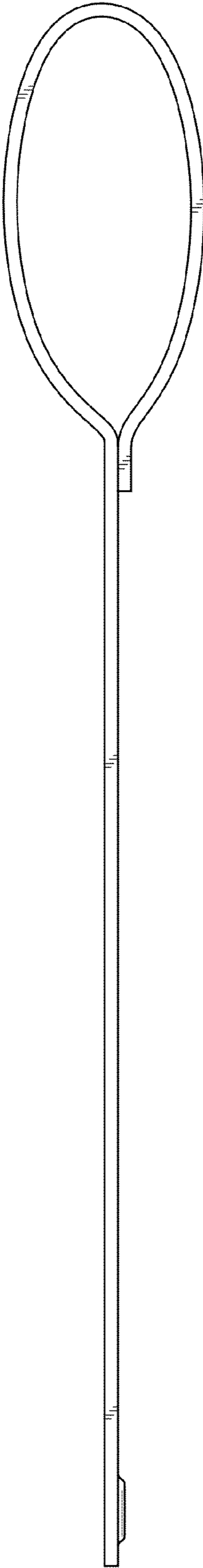

Fig. 15