



US00D721838S

(12) **United States Design Patent**  
**Dubosc**

(10) **Patent No.:** **US D721,838 S**  
(45) **Date of Patent:** **\*\* Jan. 27, 2015**

(54) **LIGHTING UNIT FOR A VEHICLE**

(56) **References Cited**

(71) Applicant: **Valeo Vision**, Bobigny Cedex (FR)

U.S. PATENT DOCUMENTS

(72) Inventor: **Christophe Dubosc**, Villemomble (FR)

D623,782 S *	9/2010	Futschik et al.	.....	D26/28
D637,746 S *	5/2011	Kong et al.	.....	D26/28
D641,505 S *	7/2011	Futschik et al.	.....	D26/28
D667,975 S *	9/2012	Evrard et al.	.....	D26/28

(73) Assignee: **Valeo Vision**, Bobigny (FR)

\* cited by examiner

(\*\*) Term: **14 Years**

*Primary Examiner* — Marcus Jackson

(21) Appl. No.: **29/450,471**

(74) *Attorney, Agent, or Firm* — Oblon, Spivak, McClelland, Maier & Neustadt, L.L.P.

(22) Filed: **Mar. 18, 2013**

(57) **CLAIM**

The ornamental design for a lighting unit for a vehicle, as shown and described.

(30) **Foreign Application Priority Data**

**DESCRIPTION**

Sep. 18, 2012 (EM) ..... 002104919-0004

FIG. 1 is a front, top, and right side perspective view of a lighting unit for a vehicle;

(51) **LOC (10) Cl.** ..... **26-06**

FIG. 2 is a front elevational view thereof;

(52) **U.S. Cl.**  
USPC ..... **D26/28**

FIG. 3 is a rear elevational view thereof;

(58) **Field of Classification Search**  
USPC ..... D26/28-36; 362/459-468, 475-478,  
362/485-487

FIG. 4 is a top plan view thereof;

FIG. 5 is a bottom plan view thereof;

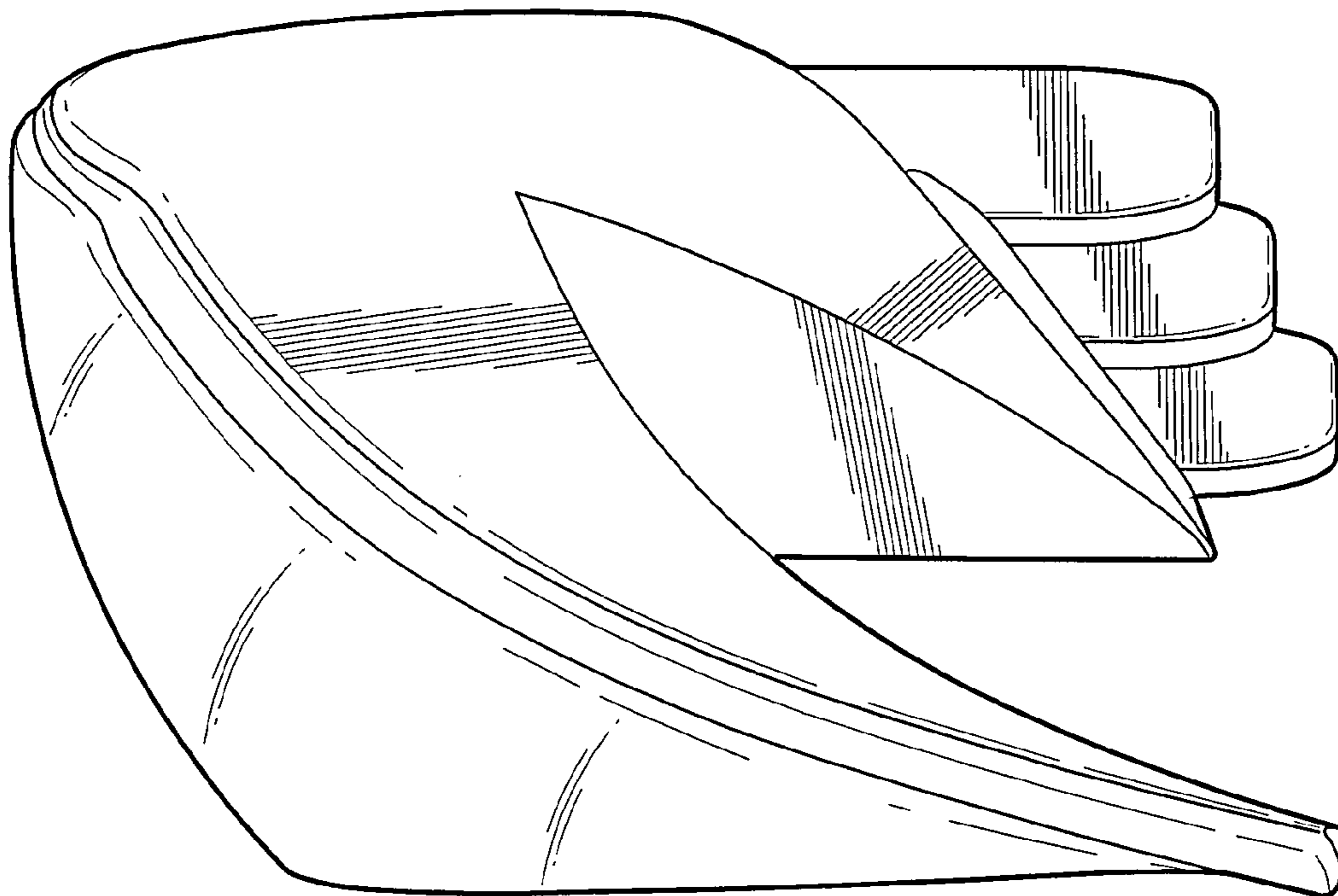
FIG. 6 is a left side elevational view thereof; and,

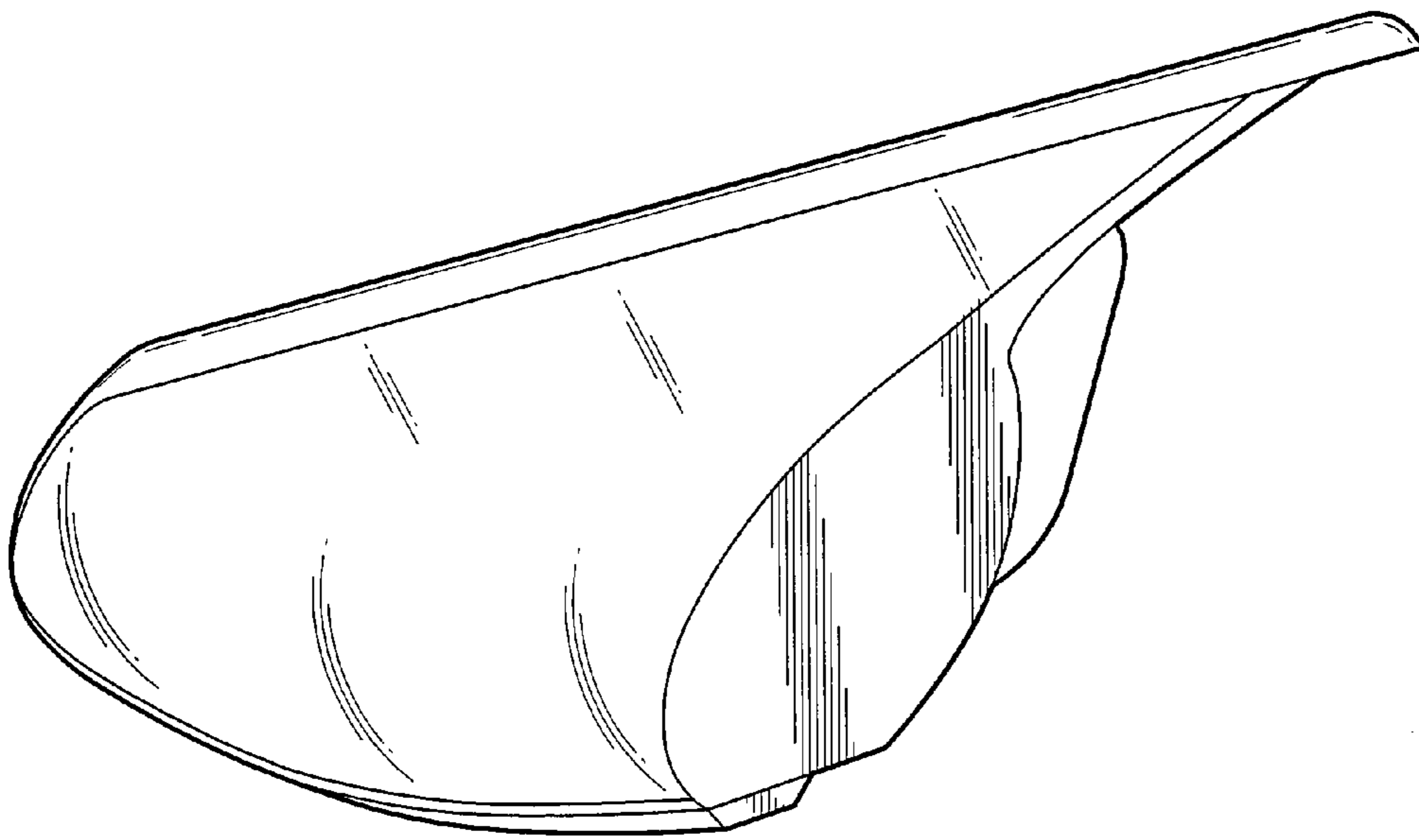
FIG. 7 is a right side elevational view thereof.

The broken lines in the drawings depict environmental subject matter only and form no part of the claimed design.

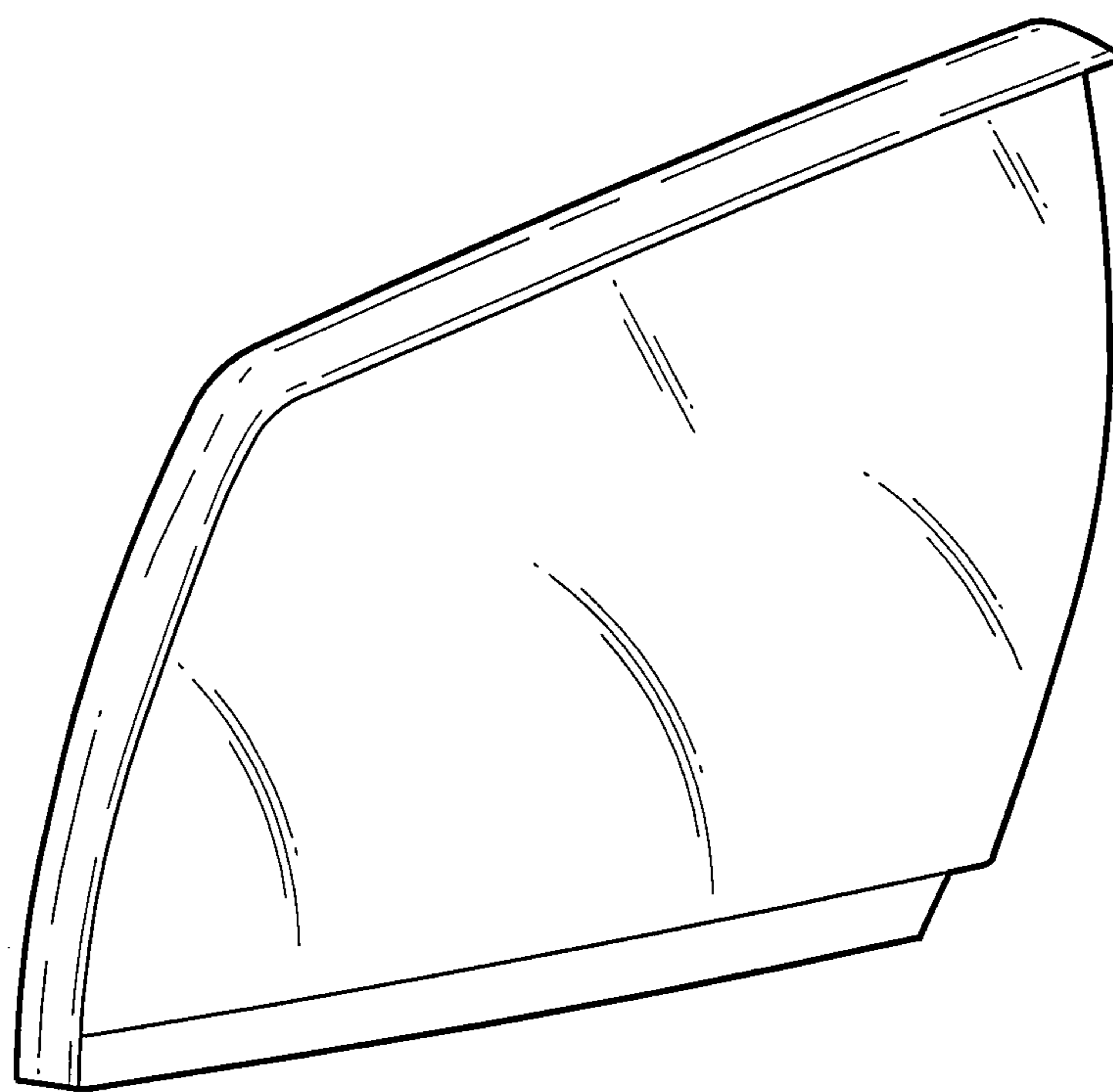
See application file for complete search history.

**1 Claim, 7 Drawing Sheets**

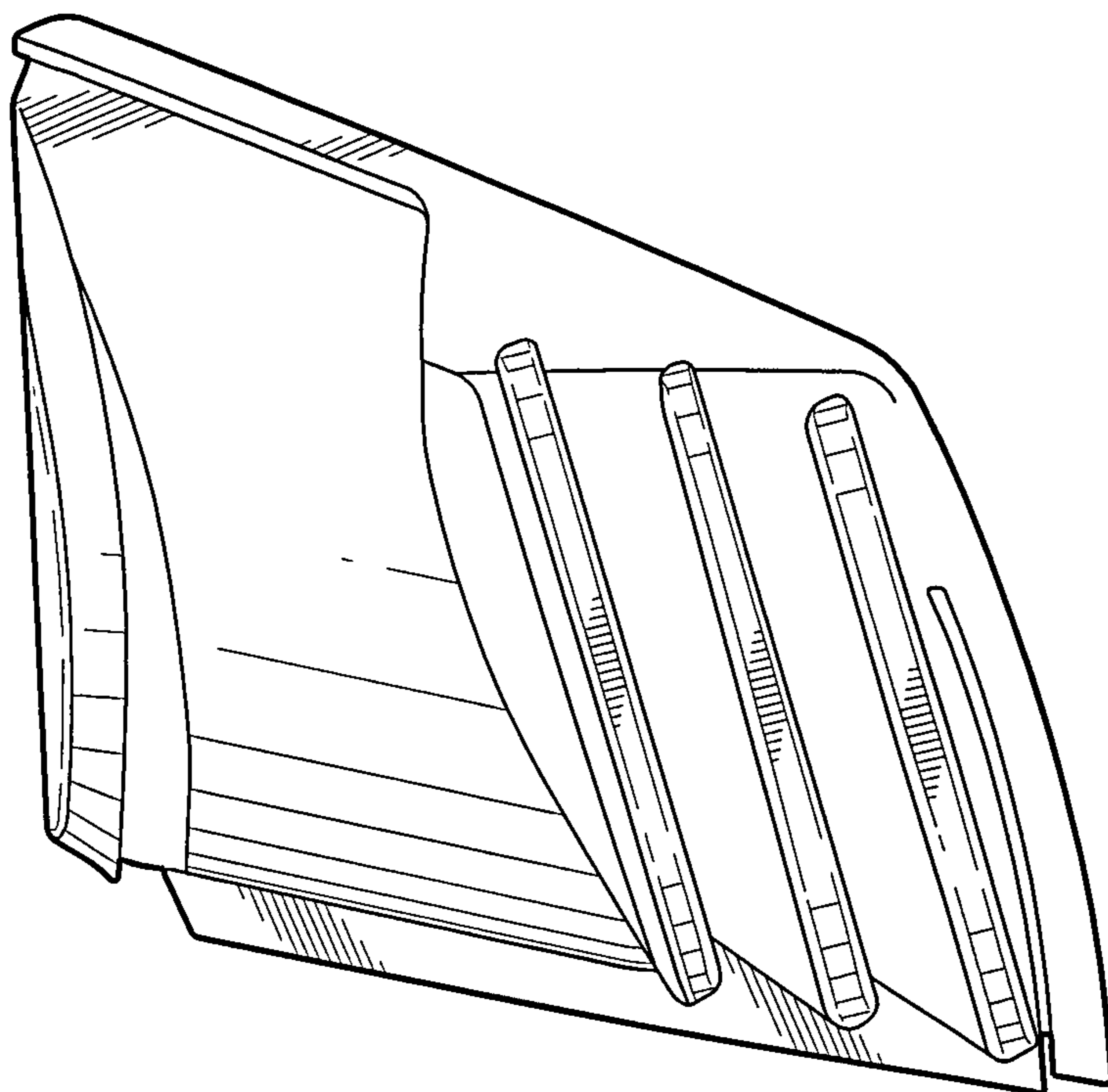




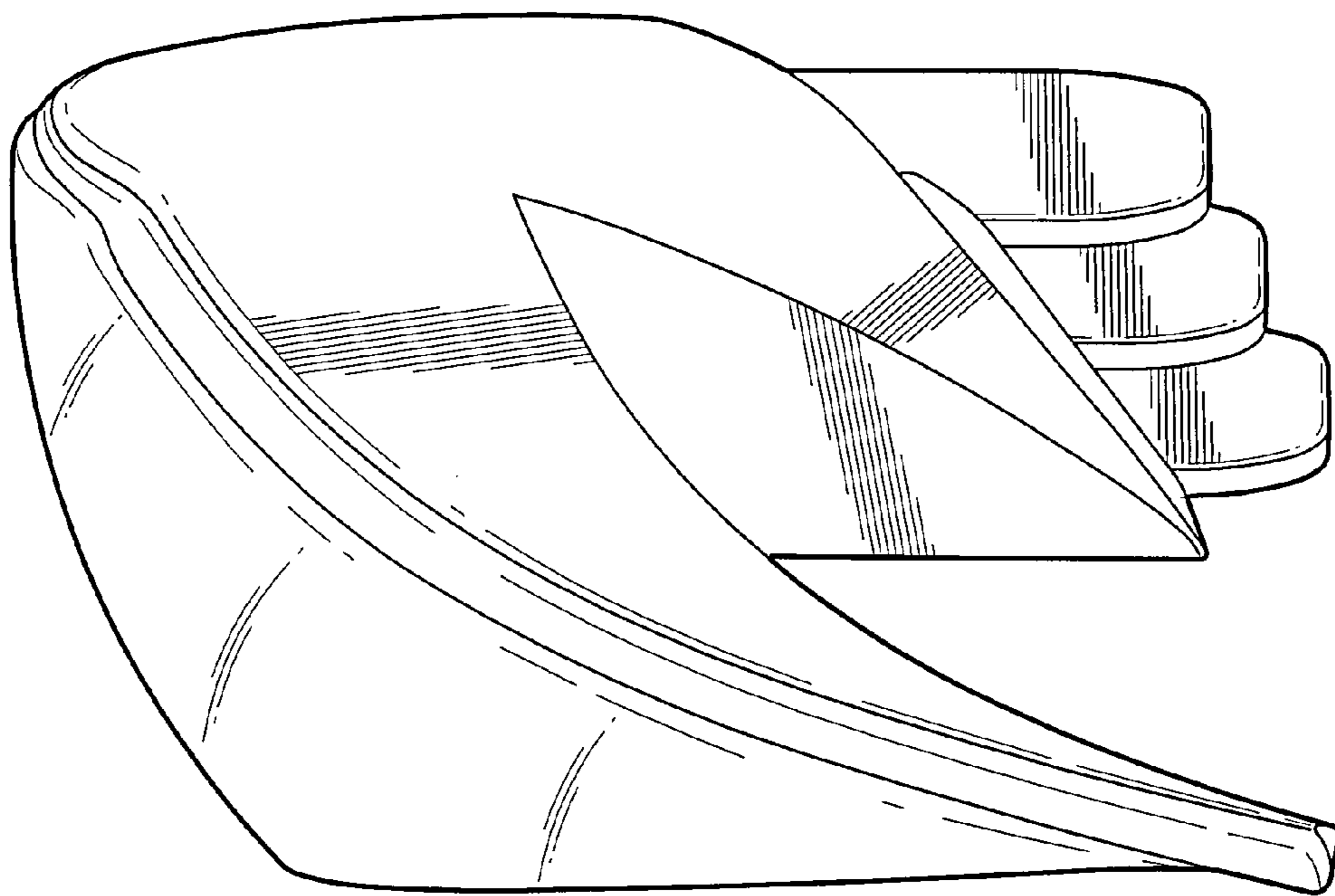
***Fig. 1***



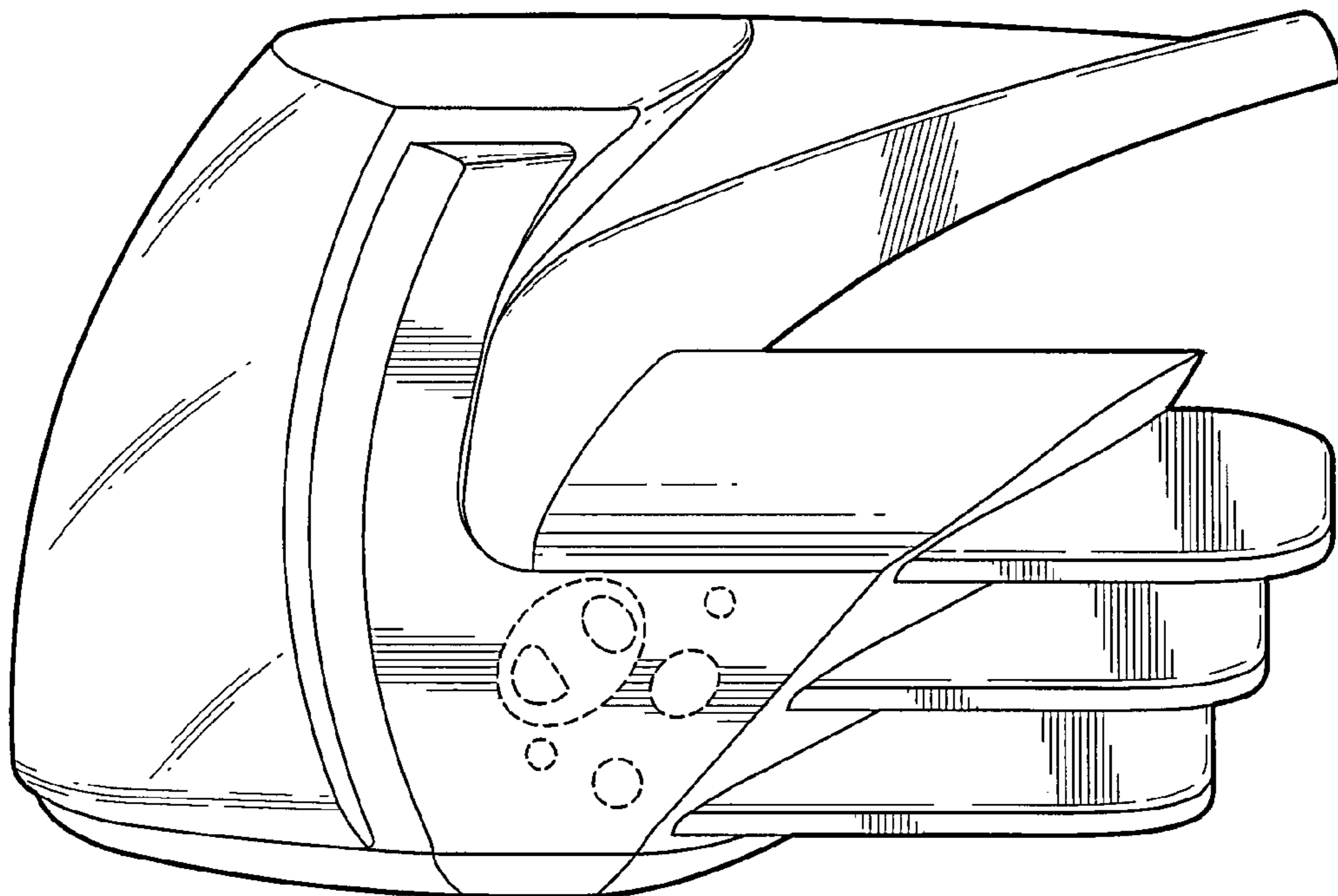
***Fig. 2***



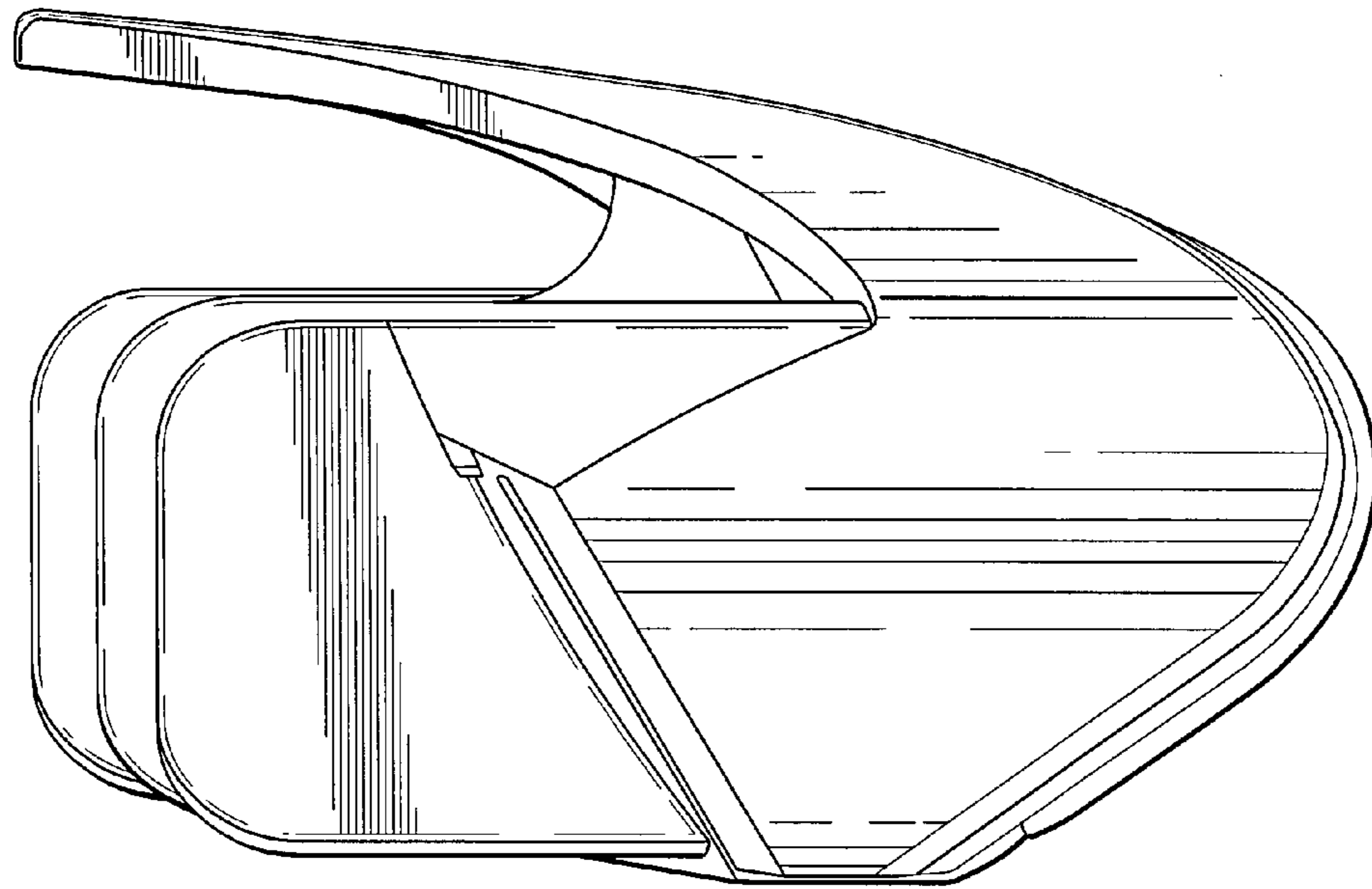
*Fig. 3*



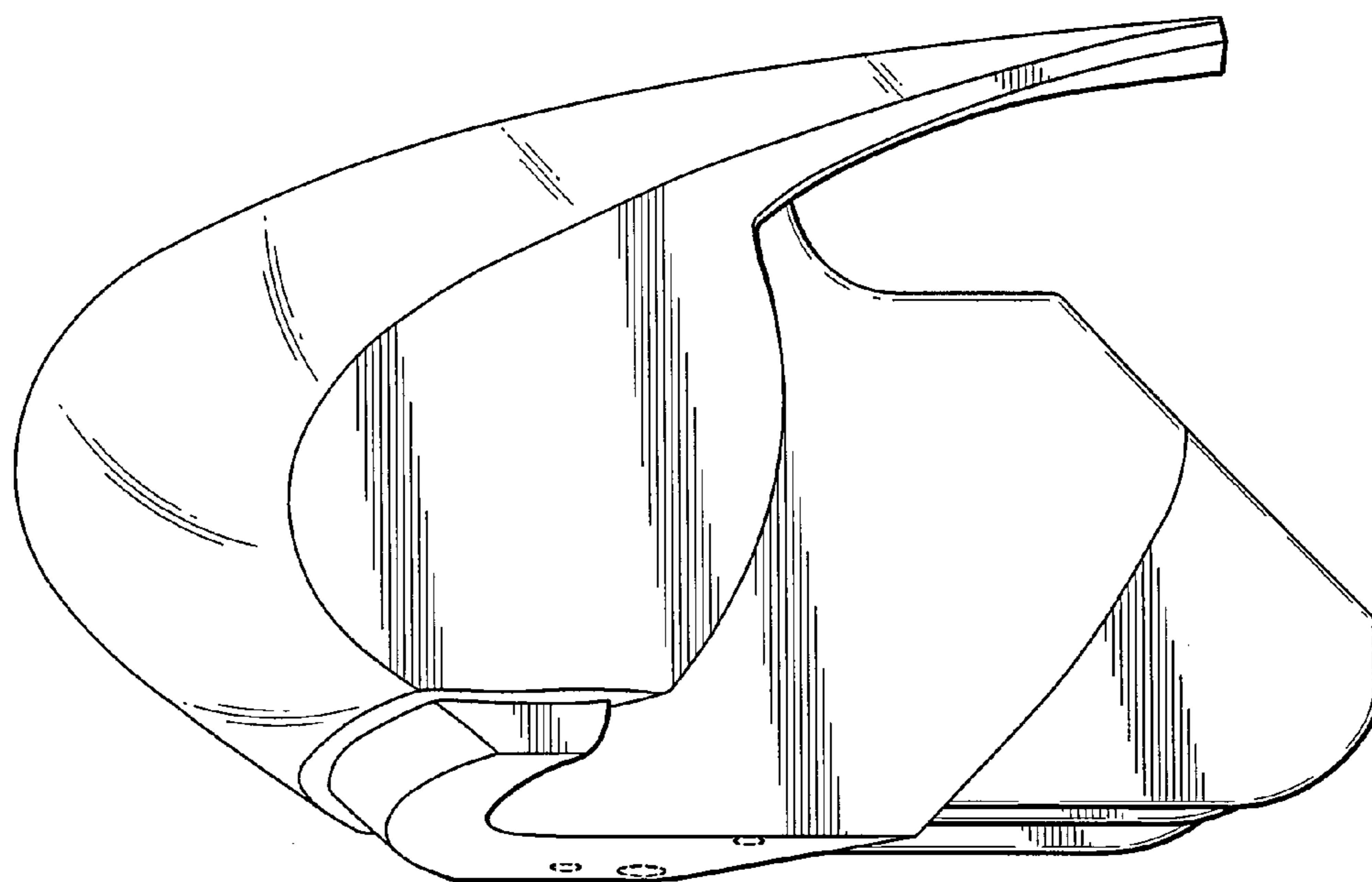
*Fig. 4*



***Fig. 5***



***Fig. 6***



***Fig. 7***