



US00D721835S

(12) **United States Design Patent**
Morton

(10) **Patent No.:** **US D721,835 S**
(45) **Date of Patent:** **** Jan. 27, 2015**

- (54) **DECORATIVE CENTERPIECE**
 - (71) Applicant: **Patsy Morton**, Memphis, TN (US)
 - (72) Inventor: **Patsy Morton**, Memphis, TN (US)
 - (**) Term: **14 Years**
 - (21) Appl. No.: **29/452,760**
 - (22) Filed: **Apr. 22, 2013**
 - (51) **LOC (10) Cl.** **23-01**
 - (52) **U.S. Cl.**
USPC **D26/9**
 - (58) **Field of Classification Search**
USPC D26/5-23; 431/288-297; 362/161-163,
362/351; D11/131, 132, 141, 143, 144,
D11/184; D6/403-405, 556, 557, 558,
D6/143-156, 164; 47/33, 39, 41.01, 41.1,
47/41.11-41.15, 44-47, 65, 65.5, 65.9,
47/66.1, 66.2, 66.6, 66.7, 67-71, 17, 32.4,
47/32.5, 32.7
- See application file for complete search history.

2011/0311925 A1* 12/2011 Chen 431/291
* cited by examiner

Primary Examiner — T. Chase Nelson
Assistant Examiner — Ania Aman
(74) *Attorney, Agent, or Firm* — Daniel Boudwin; Global Intellectual Property Agency LLC

(57) **CLAIM**
The ornamental design for a decorative centerpiece, as shown and described.

DESCRIPTION

FIG. 1 shows a perspective view of the decorative centerpiece with a flower within its body interior, a flower on its base, and a candle in its upper candleholder shown in broken line showing my new design.
FIG. 2 shows a front side elevation view of the decorative centerpiece.
FIG. 3 shows a rear side elevation view of the decorative centerpiece.
FIG. 4 shows a right side elevation view of the decorative centerpiece.
FIG. 5 shows a left side elevation view of the decorative centerpiece.
FIG. 6 shows an overhead view of the decorative centerpiece; and,
FIG. 7 shows an underside view of the decorative centerpiece. The broken lines shown in FIG. 1 are for the purpose of illustrating unclaimed environment and form no part of the claimed design.

(56) **References Cited**

U.S. PATENT DOCUMENTS

D119,982 S	7/1939	Munz	
D205,300 S	7/1966	Douglas	
D252,475 S	7/1979	Schwebel	
D253,732 S	12/1979	Van Koert	
D380,856 S *	7/1997	Perkins D26/11
5,951,278 A *	9/1999	Young et al. 431/291
D435,702 S	12/2000	Willinger	
D546,481 S	7/2007	Adams et al.	

1 Claim, 4 Drawing Sheets

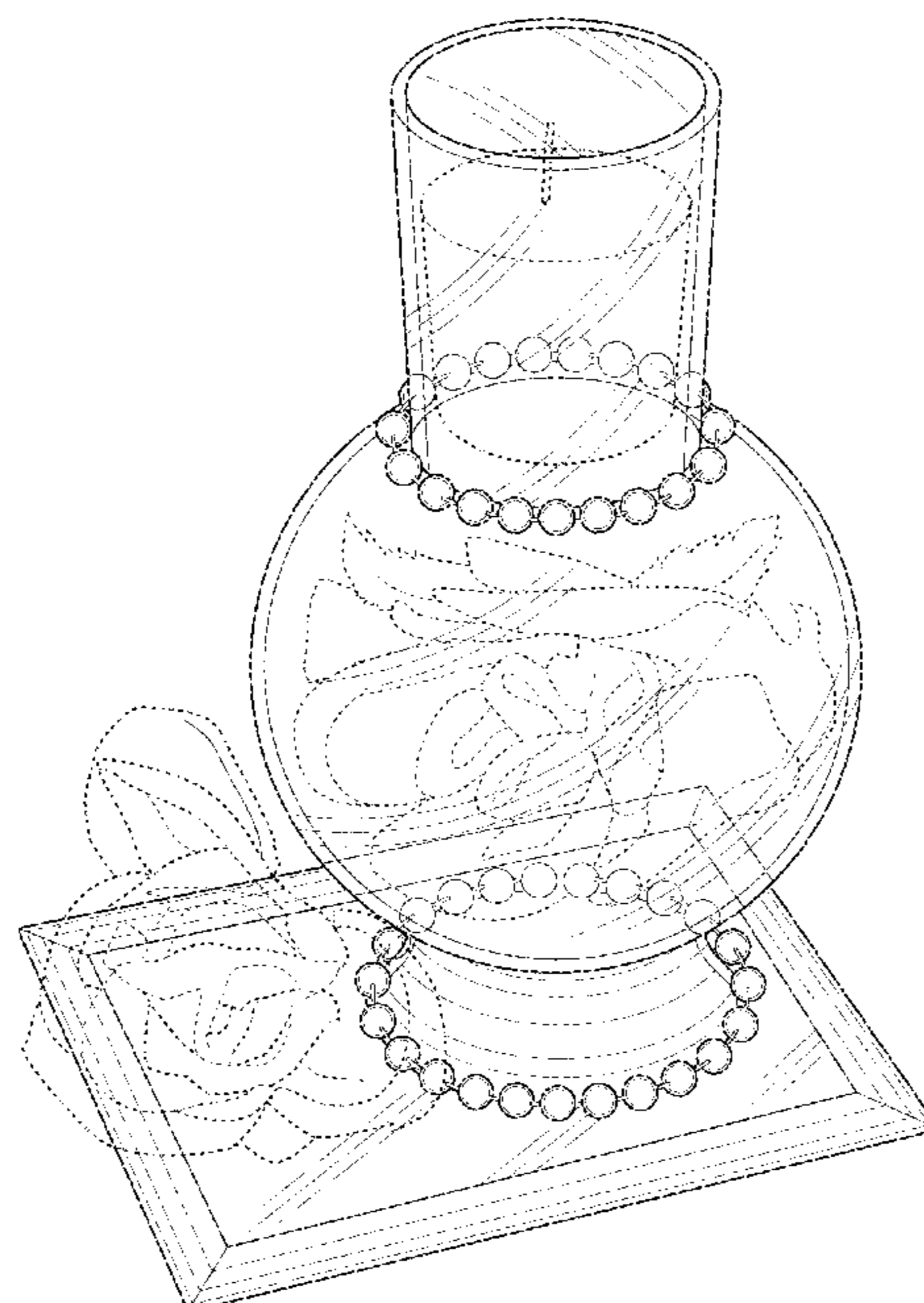

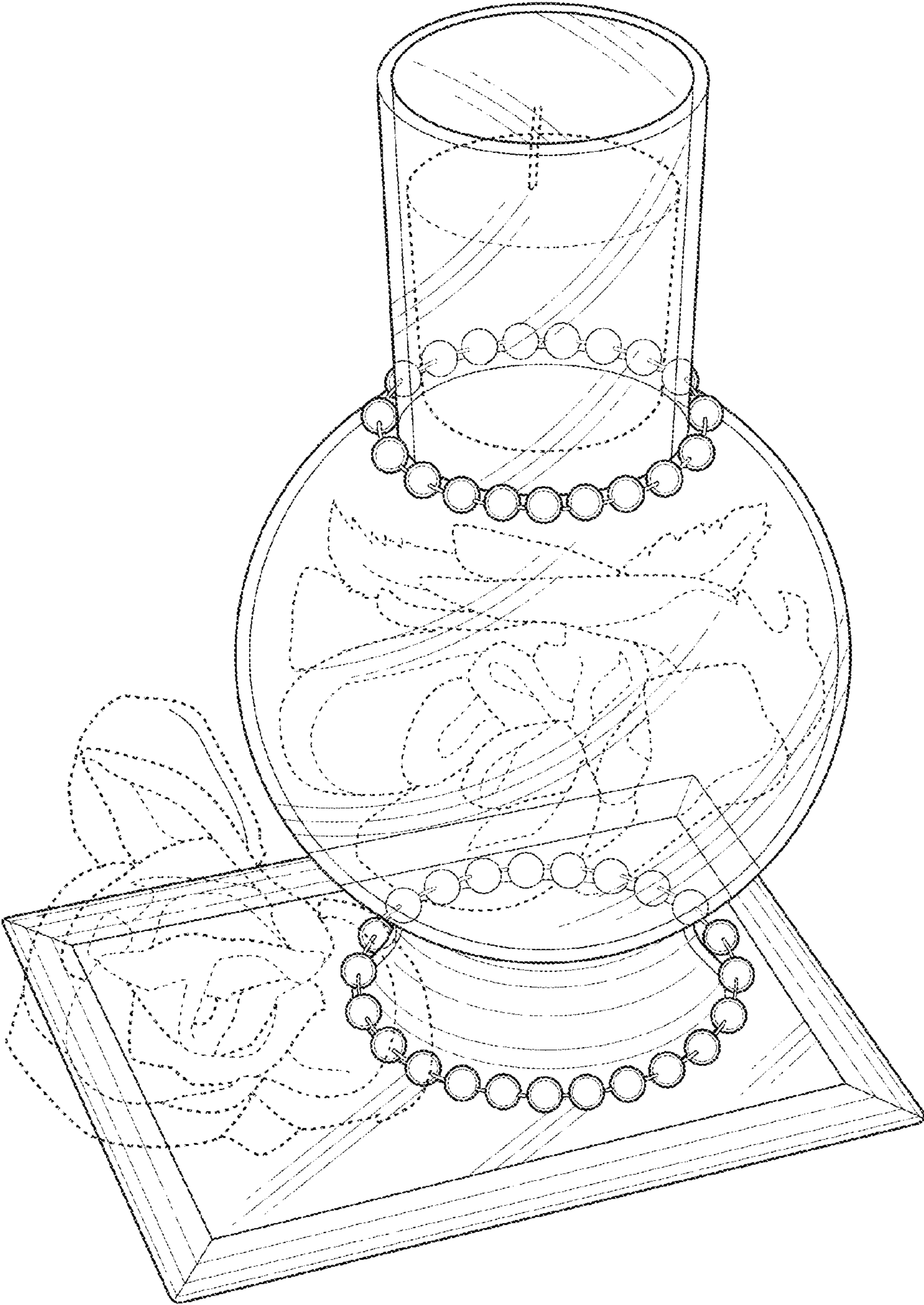

FIG. 1

FIG. 2

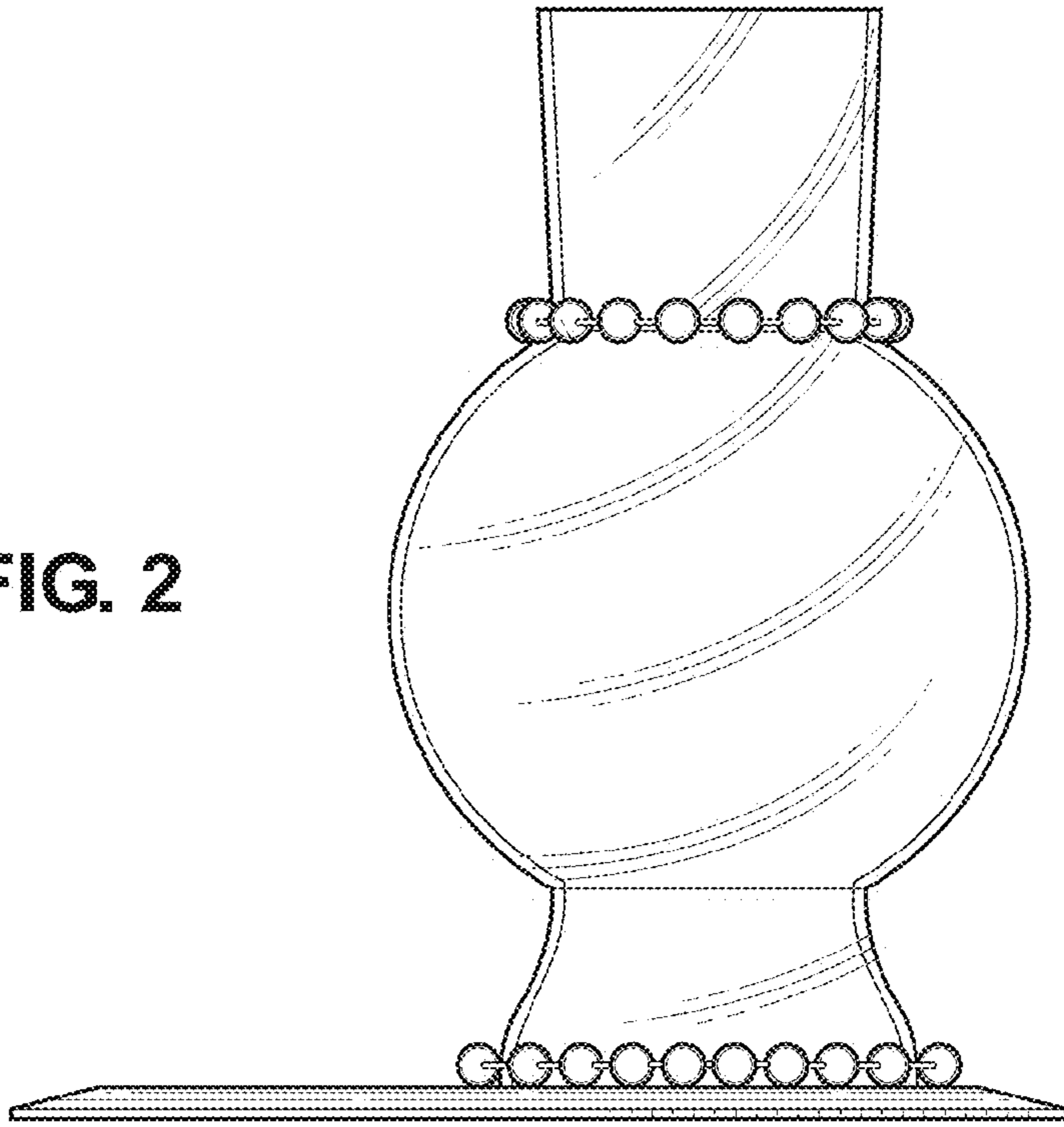
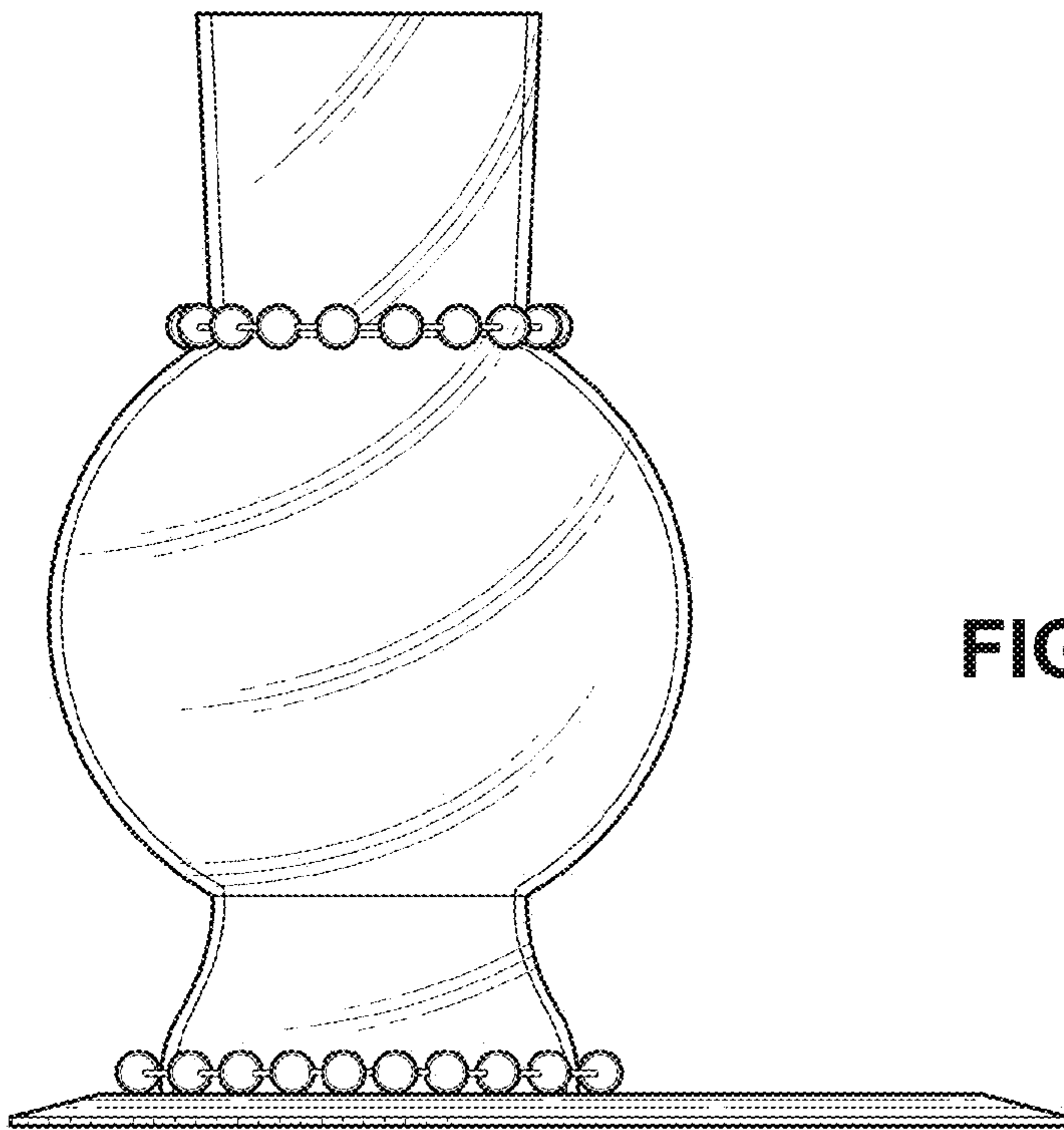

FIG. 3



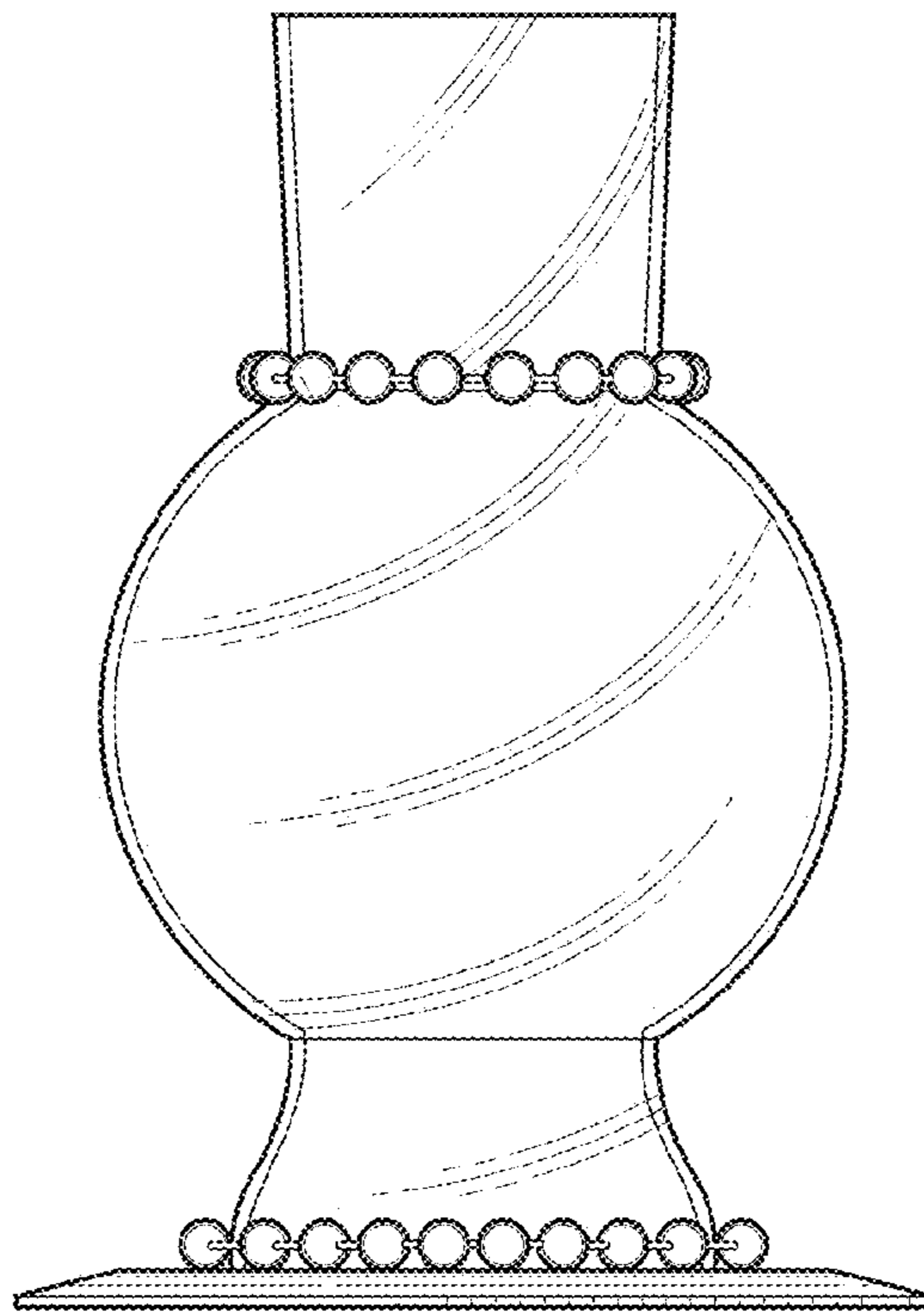

FIG. 4

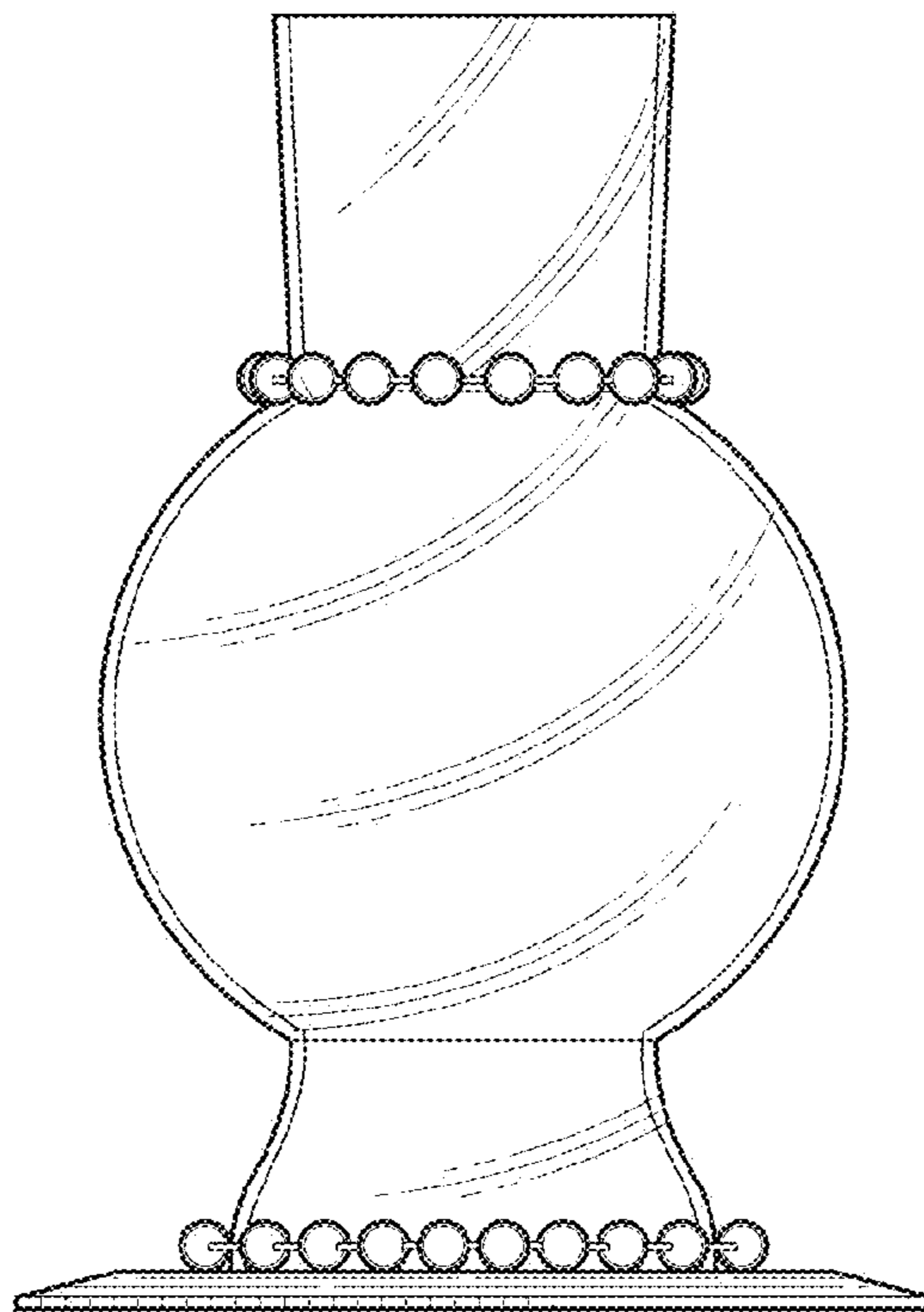

FIG. 5

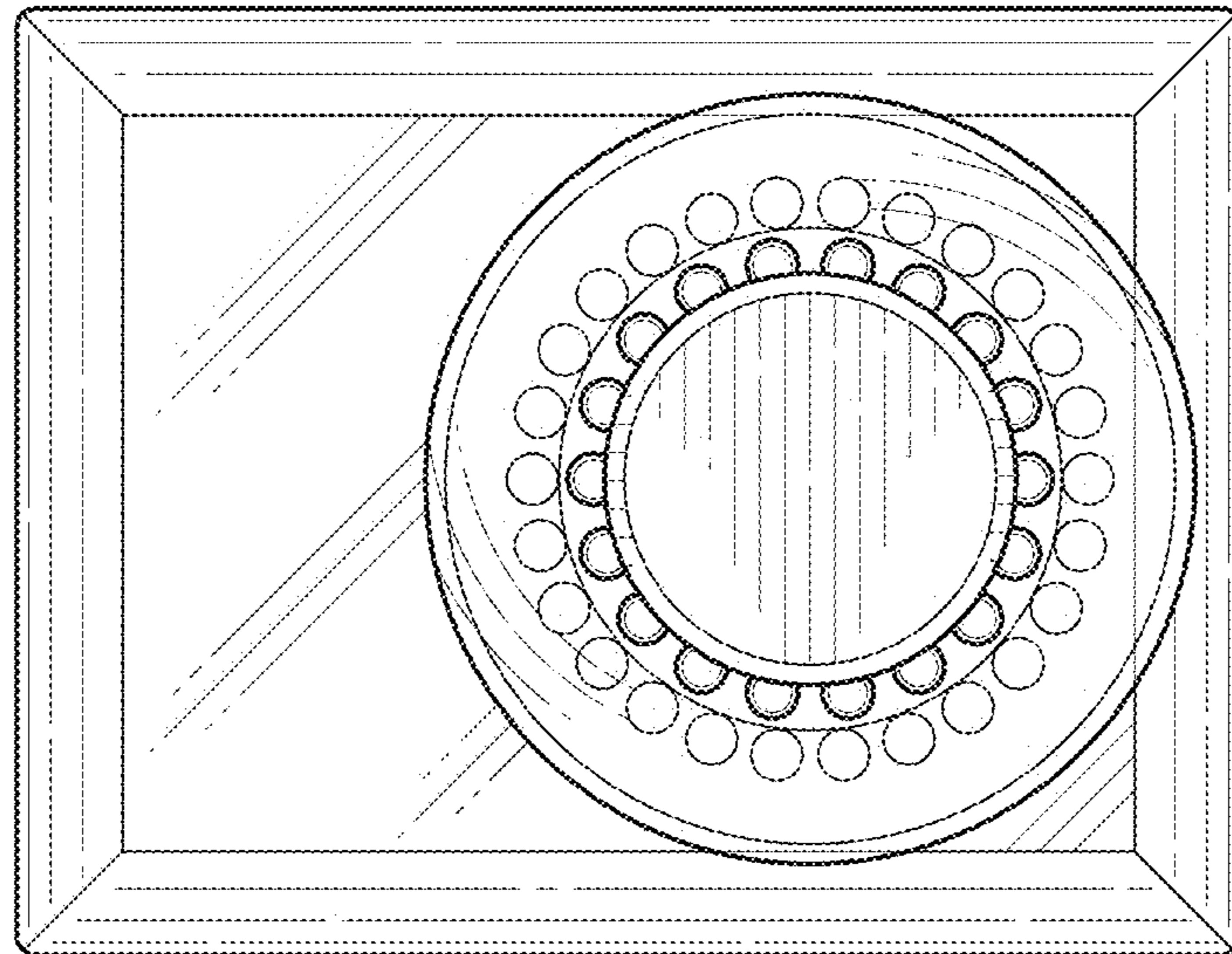

FIG. 6

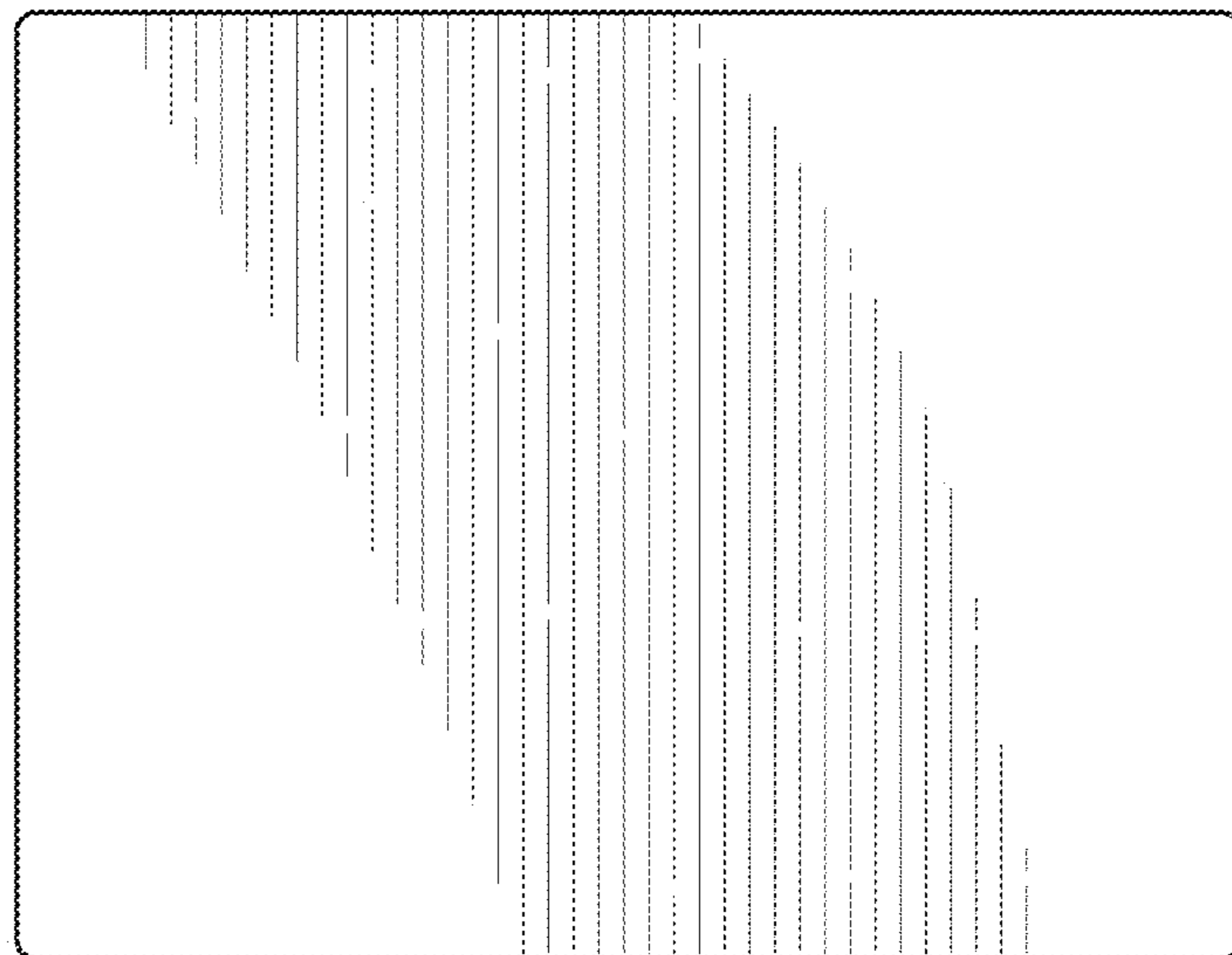

FIG. 7