



US00D721790S

(12) **United States Design Patent**  
**Bahler**

(10) **Patent No.:** **US D721,790 S**  
(45) **Date of Patent:** **\*\* Jan. 27, 2015**

(54) **FAUCET**

(71) Applicant: **Masco Corporation of Indiana,**  
Indianapolis, IN (US)

(72) Inventor: **Jordan Renee Bahler,** Westfield, IN  
(US)

(73) Assignee: **Masco Corporation of Indiana,**  
Indianapolis, IN (US)

(\*\*) Term: **14 Years**

(21) Appl. No.: **29/488,608**

(22) Filed: **Apr. 22, 2014**

(51) **LOC (10) Cl.** ..... **23-01**

(52) **U.S. Cl.**  
USPC ..... **D23/238**

(58) **Field of Classification Search**  
CPC ..... E03C 1/04; E03C 1/0401; E03C 1/0402;  
E03C 1/0404  
USPC ..... D23/238, 241-243, 249, 250, 252, 255,  
D23/257

See application file for complete search history.

(56) **References Cited**

U.S. PATENT DOCUMENTS

D525,347 S \* 7/2006 Schaffeld et al. .... D23/255  
D575,849 S \* 8/2008 Ko ..... D23/238  
D601,682 S \* 10/2009 Schoenherr et al. .... D23/328  
D673,651 S \* 1/2013 Uhl ..... D23/238

\* cited by examiner

*Primary Examiner* — Robert Delehanty

(74) *Attorney, Agent, or Firm* — Edgar A. Zarins; Nirav D. Parikh

(57) **CLAIM**

The ornamental design for a faucet, as shown and described.

**DESCRIPTION**

FIG. 1 is a perspective view of a faucet showing my new design;  
FIG. 2 is a front view thereof;  
FIG. 3 is a rear view thereof;  
FIG. 4 is a right side view thereof;  
FIG. 5 is a left side view thereof;  
FIG. 6 is a top plan view thereof; and,  
FIG. 7 is a bottom view thereof.

**1 Claim, 2 Drawing Sheets**

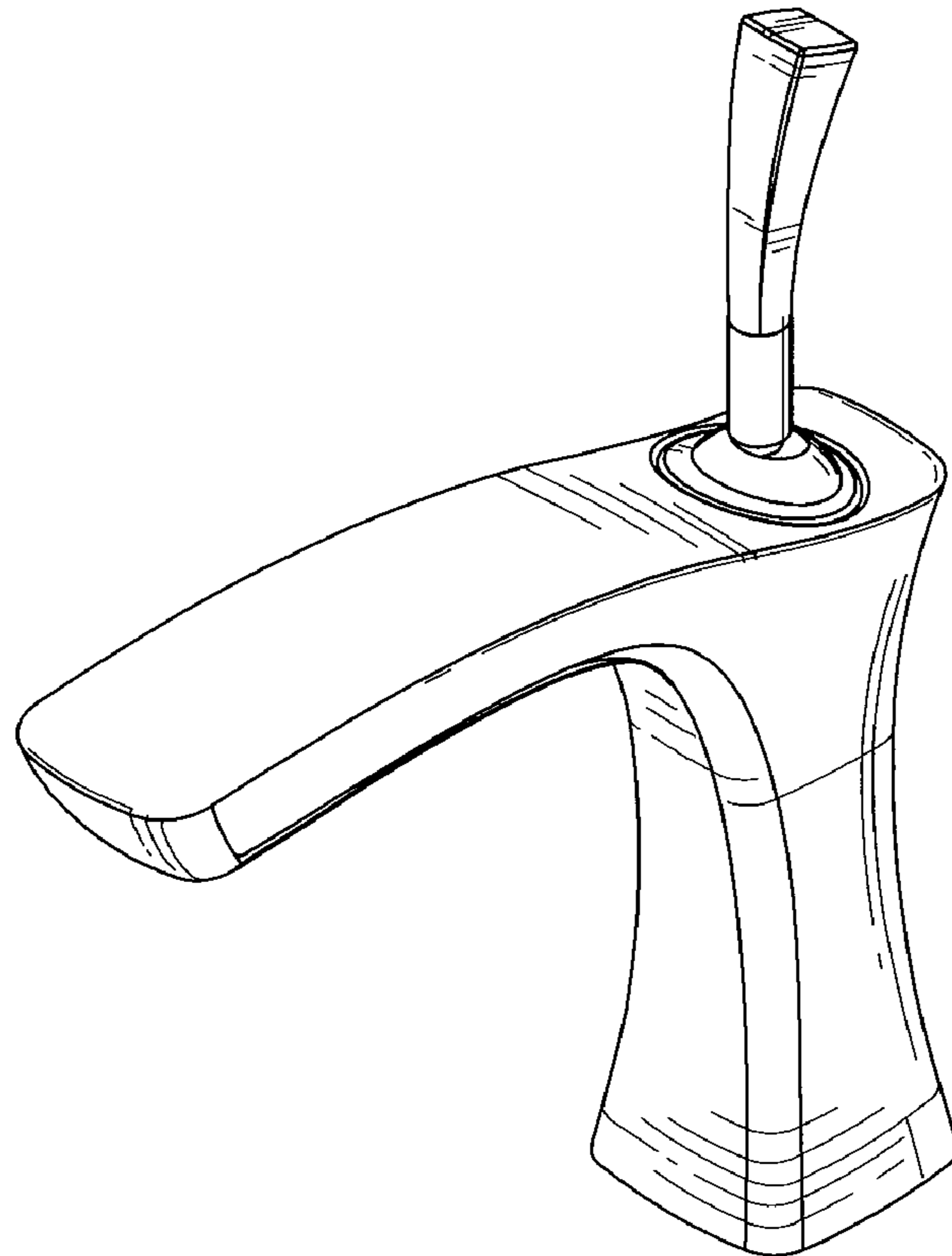

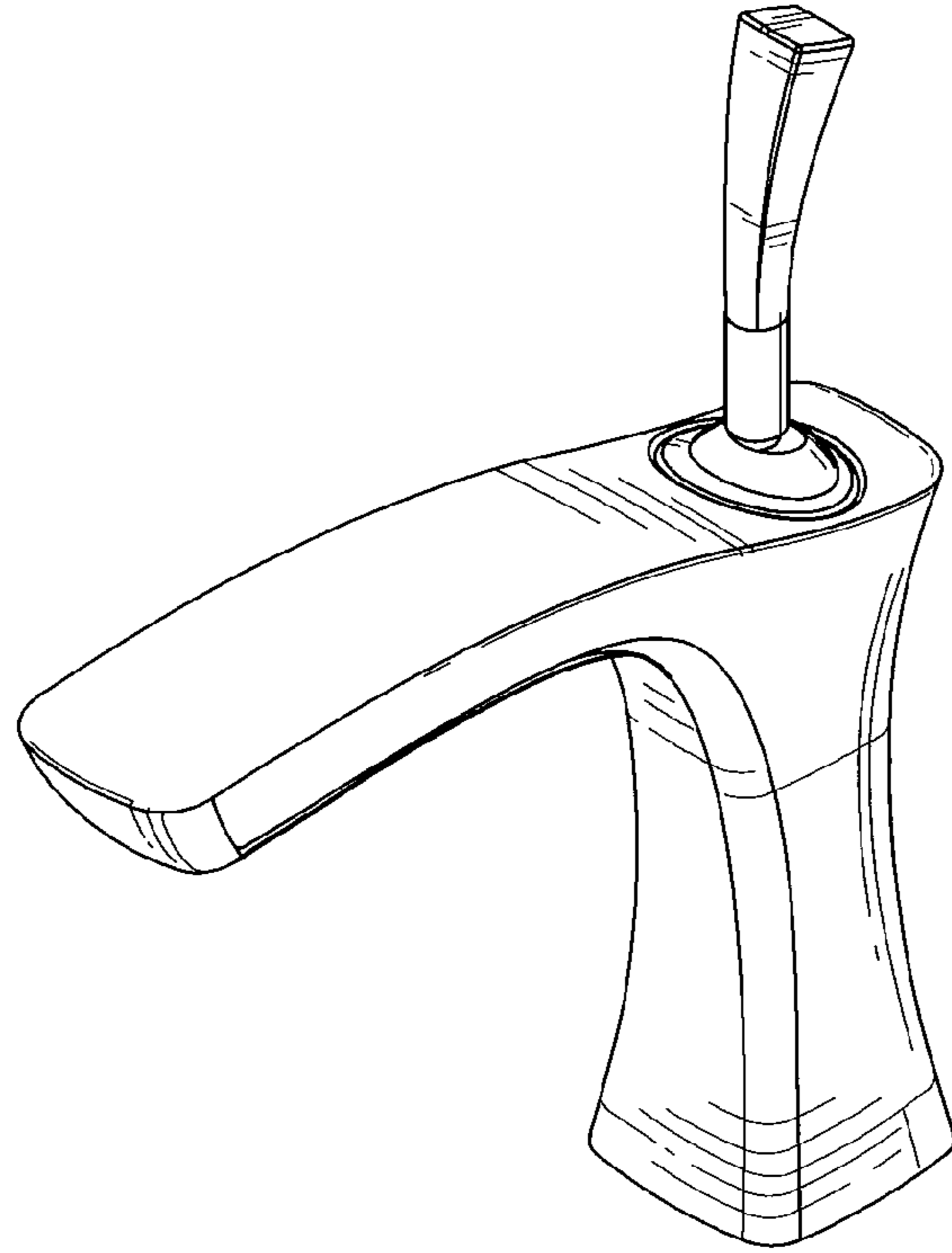

Fig-1

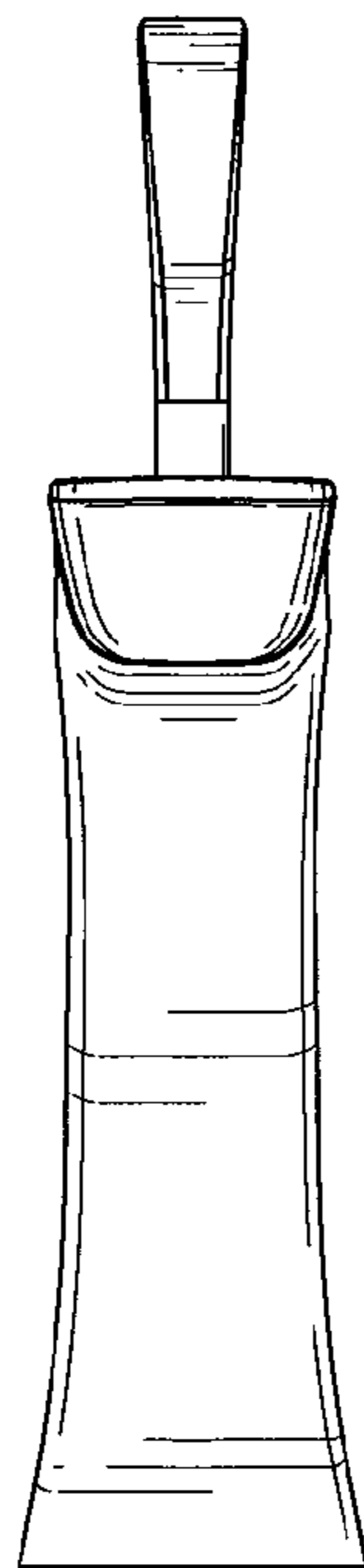

Fig-2

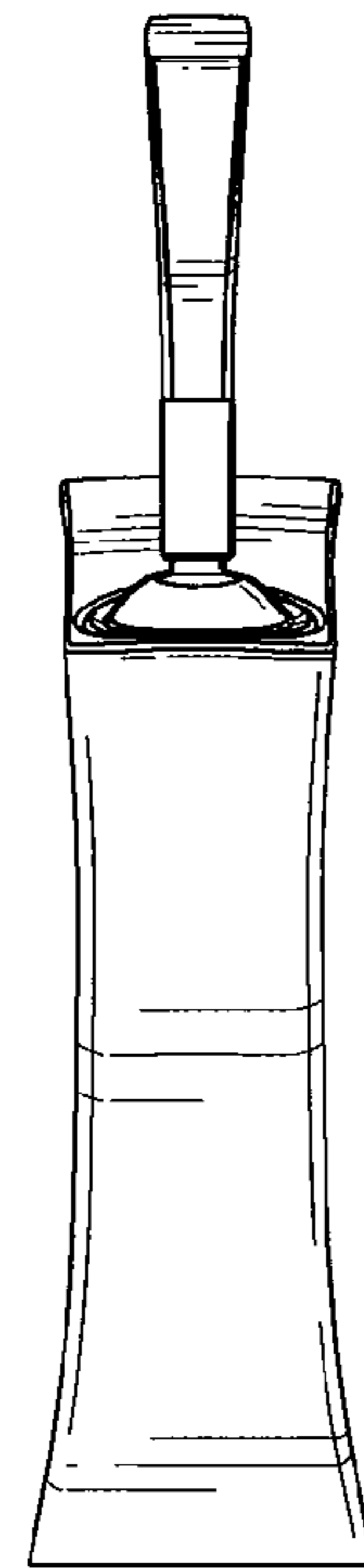

Fig-3

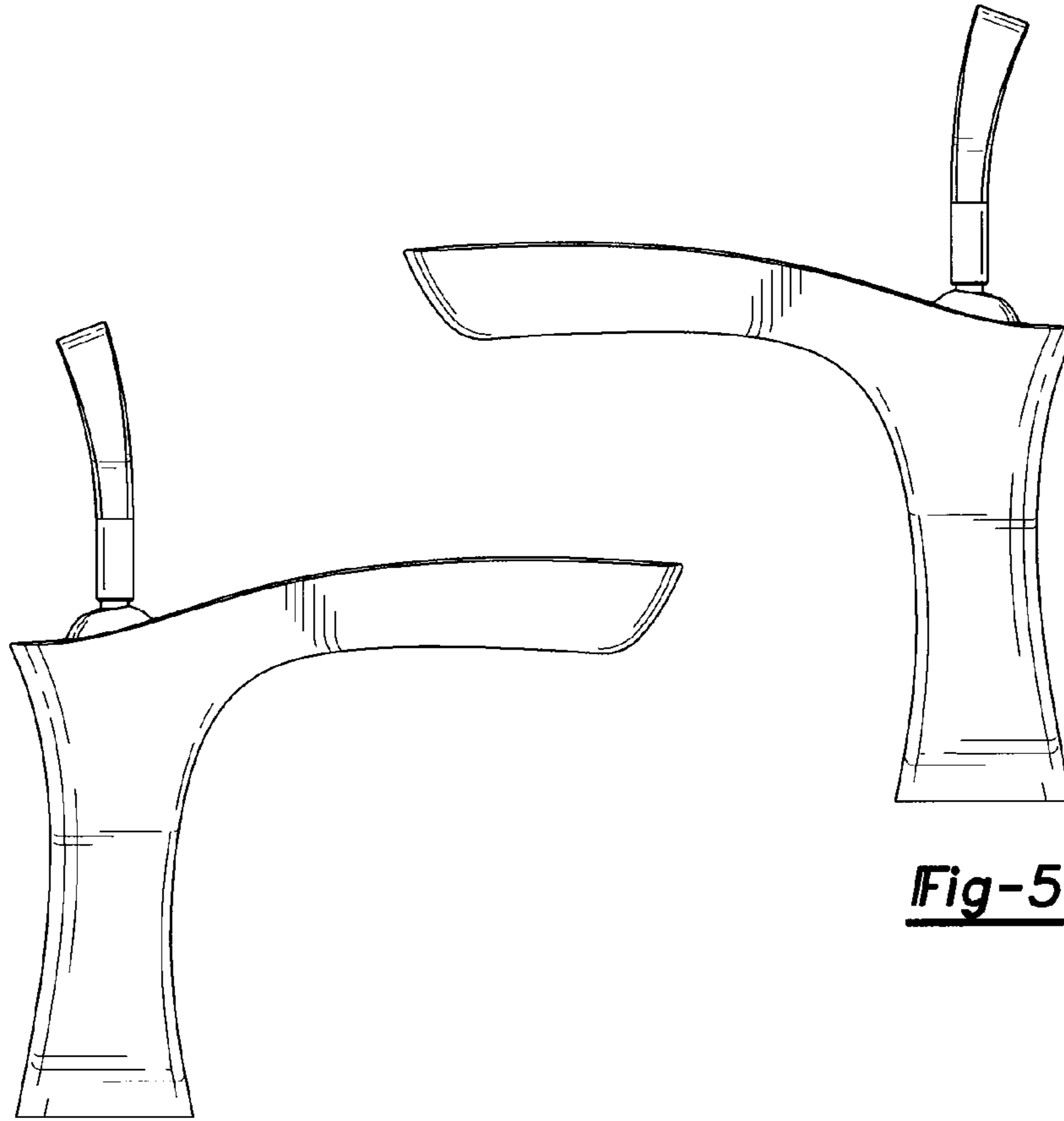

Fig-4

Fig-5

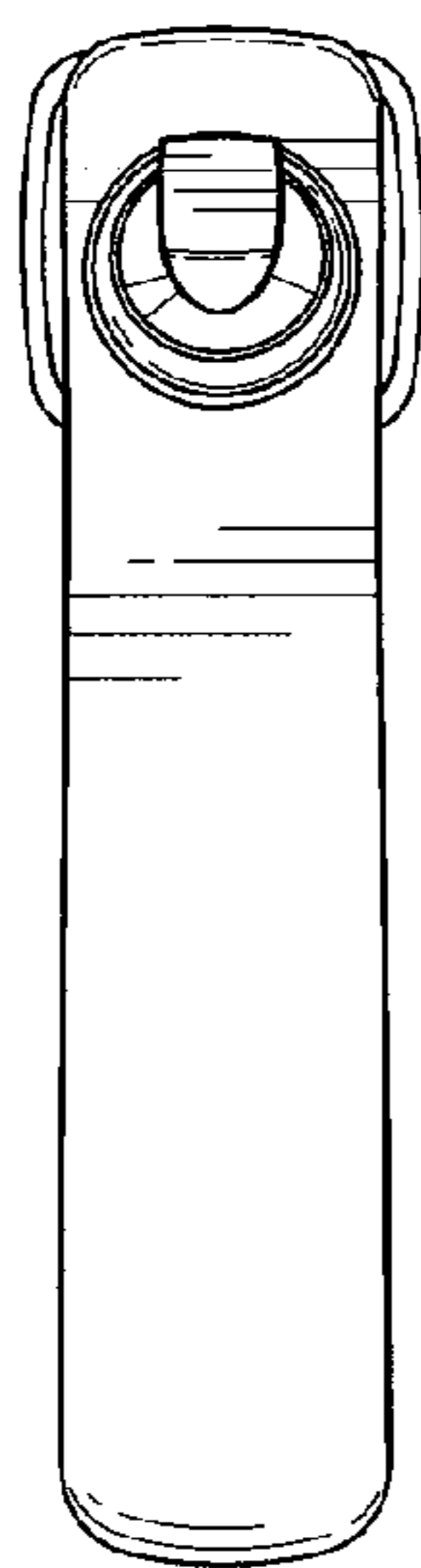

Fig-6

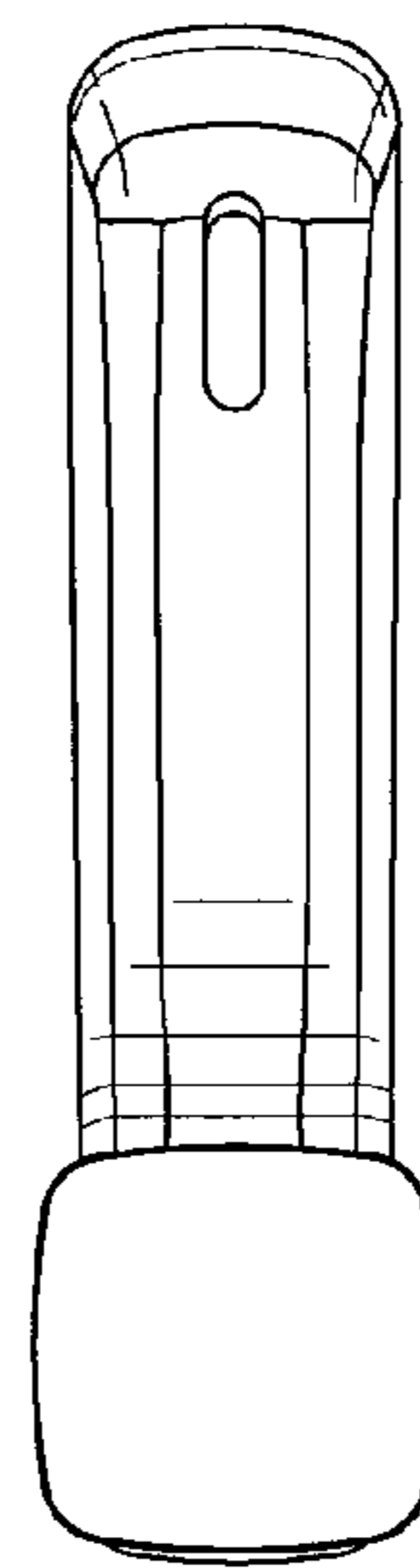

Fig-7