

US00D721698S

(12) **United States Design Patent**  
**Lee et al.**

(10) **Patent No.:** **US D721,698 S**  
(45) **Date of Patent:** **\*\* Jan. 27, 2015**

(54) **PORTABLE COMPUTER**

FOREIGN PATENT DOCUMENTS

(71) Applicant: **Samsung Electronics Co., Ltd.**,  
Suwon-Si, Gyeonggi-do (KR)

KR 3005506890000 1/2010  
KR 3005544080000 2/2010

(Continued)

(72) Inventors: **Son-Young Lee**, Seoul (KR); **Jun-Se Kim**, Gwank-gu (KR); **Chang-Ho Lee**, Gwank-gu (KR); **Sang-Won Yoon**, Seocho-gu (KR); **Won-Suk Chung**, Gangnam-gu (KR)

OTHER PUBLICATIONS

Design U.S. Appl. No. 29/457,870 Inventor: Son-Young Lee, et al., filed Jun. 13, 2013 entitled Body of Portable Computer.

(Continued)

(73) Assignee: **Samsung Electronics Co., Ltd.**,  
Suwon-Si (KR)

*Primary Examiner* — Freda S Nunn

(74) *Attorney, Agent, or Firm* — Wood, Herron & Evans, LLP

(\*\*) Term: **14 Years**

(57) **CLAIM**

The ornamental design for a portable computer, as shown and described.

(21) Appl. No.: **29/457,867**

(22) Filed: **Jun. 13, 2013**

**DESCRIPTION**

(30) **Foreign Application Priority Data**

Dec. 14, 2012 (KR) ..... 30-2012-0060450

(51) **LOC (10) Cl.** ..... **14-02**

(52) **U.S. Cl.**  
USPC ..... **D14/316**

(58) **Field of Classification Search**  
USPC ..... D14/315-327, 331; D18/1, 2, 7, 11;  
235/145 A, 145 R; 341/22, 23; 345/104,  
345/156, 168, 169, 173; 361/679.08,  
361/679.09, 679.11, 679.26, 679.27;  
379/433.12; 16/341, 367

See application file for complete search history.

FIG. 1 is a top front perspective view of a portable computer showing our new design;

FIG. 2 is a front view thereof;

FIG. 3 is a rear view thereof;

FIG. 4 is a left side view thereof;

FIG. 5 is a right side view thereof;

FIG. 6 is a top view thereof;

FIG. 7 is a bottom view thereof;

FIG. 8 is a top front perspective view thereof, in which a display portion is obliquely stood for use;

FIG. 9 is a right side view thereof showing a first mode, in which an end of a display portion is slightly lifted;

FIG. 10 is a right side view thereof showing a second mode, in which both ends of the display portion are lifted with oblique; and,

FIG. 11 is a right side view thereof showing a third mode, in which the display portion is obliquely positioned on the rear of the portable computer.

The broken lines illustrating portions of the portable computer are for environmental purposes only and form no part of the claimed design.

(56) **References Cited**

U.S. PATENT DOCUMENTS

D270,061 S 8/1983 Ackeret  
D284,084 S 6/1986 Ferrara, Jr.  
D306,583 S 3/1990 Krolopp et al.

(Continued)

**1 Claim, 7 Drawing Sheets**

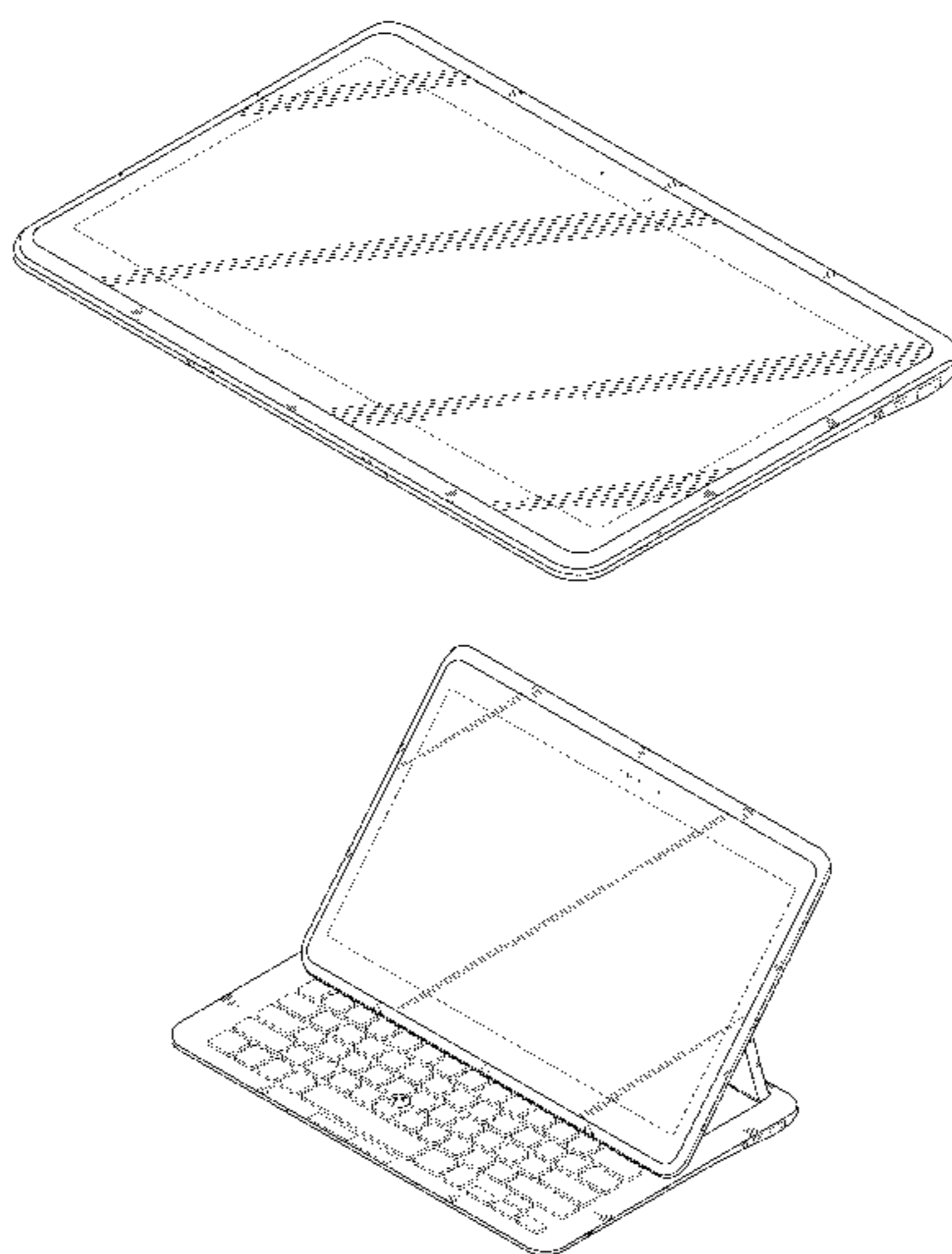

(56)

References Cited

U.S. PATENT DOCUMENTS

D333,574 S	3/1993	Ackeret	
D337,569 S	7/1993	Kando	
5,267,123 A	11/1993	Boothroyd et al.	
5,887,723 A	3/1999	Myles et al.	
D416,238 S	11/1999	Irie et al.	
6,067,224 A	5/2000	Nobuchi	
6,259,597 B1	7/2001	Anzai et al.	
D460,759 S	7/2002	West et al.	
D463,797 S	10/2002	Andre et al.	
6,519,139 B2	2/2003	Kambayashi	
D490,420 S	5/2004	Solomon et al.	
6,775,129 B1	8/2004	Ghosh et al.	
6,781,819 B2	8/2004	Yang et al.	
6,785,128 B1	8/2004	Yun	
D499,704 S	12/2004	Song	
6,829,140 B2	12/2004	Shimano et al.	
D500,991 S	1/2005	Niitsu	
D504,889 S	5/2005	Andre et al.	
D517,545 S	3/2006	Buckel et al.	
D528,541 S *	9/2006	Maskatia .....	D14/315
D532,791 S	11/2006	Kim	
D535,292 S *	1/2007	Shi et al. ....	D14/315
7,158,634 B2 *	1/2007	Eromaki .....	379/433.13
D540,790 S	4/2007	Kim et al.	
D558,460 S	1/2008	Yu et al.	
D563,804 S	3/2008	Kimura et al.	
D564,511 S	3/2008	Akhtar	
D579,930 S	11/2008	Maskatia	
D584,738 S	1/2009	Kim et al.	
D587,710 S	3/2009	Han	
D588,126 S	3/2009	Chiang et al.	
D589,511 S	3/2009	Han	
D589,958 S	4/2009	Han	
D590,374 S	4/2009	Madonna et al.	
D592,212 S	5/2009	Hamada et al.	
D592,214 S	5/2009	Bradford	
7,542,284 B1	6/2009	Wilson, Sr.	
D601,138 S	9/2009	Solomon et al.	
D602,014 S	10/2009	Andre et al.	
D602,487 S	10/2009	Maskatia	
7,599,487 B2 *	10/2009	Lim .....	379/433.12
D604,291 S	11/2009	Andre et al.	
D605,626 S	12/2009	Park	
D606,539 S	12/2009	Liao et al.	
D606,961 S	12/2009	Aarras	
D610,582 S	2/2010	Sugitani et al.	
D611,364 S	3/2010	Lenz et al.	
D613,510 S	4/2010	Tzeng et al.	
D613,951 S	4/2010	Tang et al.	
D613,961 S	4/2010	Lin	
7,690,576 B2 *	4/2010	Ladouceur et al. ....	235/486
D616,440 S	5/2010	Lee	
D616,886 S	6/2010	Andre et al.	
D617,793 S	6/2010	Chiang et al.	
D622,270 S	8/2010	Andre et al.	
D624,914 S	10/2010	Wang	
D625,306 S	10/2010	Miyawaki	
D626,124 S	10/2010	Chyan et al.	
D626,437 S	11/2010	Lee et al.	
D626,547 S *	11/2010	Li et al. ....	D14/316
D627,667 S	11/2010	Lenz et al.	
D628,913 S	12/2010	Cheng	
D629,771 S	12/2010	Haspil et al.	
D629,799 S	12/2010	Andre et al.	
D630,636 S	1/2011	Jeon et al.	
D631,455 S	1/2011	Kim et al.	
D631,469 S	1/2011	Demskie et al.	
D633,498 S	3/2011	Andre et al.	
D634,318 S	3/2011	Buckle et al.	
D634,745 S	3/2011	Park et al.	
7,916,889 B2	3/2011	Takakusaki	
D636,391 S	4/2011	Shen et al.	
D636,769 S	4/2011	Wood et al.	
D636,770 S	4/2011	Li	
D638,392 S	5/2011	Price et al.	
D638,412 S	5/2011	Lee	
D639,226 S	6/2011	Juergens et al.	
D639,804 S	6/2011	Hwang et al.	
D639,805 S	6/2011	Song et al.	
D639,806 S	6/2011	Lee et al.	
D640,220 S	6/2011	Shyu et al.	
D640,255 S	6/2011	Lee et al.	
D641,018 S	7/2011	Lee et al.	
7,986,983 B2	7/2011	Harmon et al.	
D645,465 S	9/2011	Lin et al.	
D645,833 S	9/2011	Seflic et al.	
D646,902 S	10/2011	Woo et al.	
D650,381 S	12/2011	Park et al.	
D651,206 S	12/2011	Kim et al.	
D651,597 S	1/2012	Lee et al.	
D651,598 S	1/2012	Kim et al.	
D651,599 S	1/2012	Kim et al.	
D651,600 S	1/2012	Lee et al.	
D652,415 S	1/2012	Lee et al.	
D652,416 S	1/2012	Park et al.	
D652,417 S	1/2012	Lee et al.	
D652,831 S	1/2012	Lee et al.	
D654,073 S	2/2012	Li	
D654,468 S	2/2012	Duan et al.	
D654,498 S	2/2012	Hwang et al.	
D654,893 S	2/2012	Jung	
D657,785 S	4/2012	Lee et al.	
D658,173 S	4/2012	Kim	
D659,692 S	5/2012	Jung et al.	
D661,294 S	6/2012	Park et al.	
D661,295 S	6/2012	Park et al.	
D661,298 S	6/2012	Park et al.	
D661,299 S	6/2012	Kim et al.	
D661,300 S	6/2012	Kim et al.	
D661,301 S	6/2012	Kim et al.	
D661,302 S	6/2012	Fukasawa et al.	
D663,281 S	7/2012	Hwang	
D663,298 S	7/2012	Song et al.	
D664,532 S	7/2012	Lee	
D664,533 S	7/2012	Lee et al.	
D664,534 S	7/2012	Lee et al.	
D664,535 S	7/2012	Lee et al.	
D664,540 S	7/2012	Kim et al.	
D664,954 S	8/2012	Kim et al.	
D664,955 S	8/2012	Kim et al.	
D666,198 S	8/2012	Van Den Nieuwenhuizen et al.	
D667,396 S	9/2012	Koh	
D667,397 S	9/2012	Koh	
D667,398 S	9/2012	Koh	
D667,399 S	9/2012	Koh	
D667,825 S	9/2012	Jung	
D668,650 S	10/2012	Han	
D668,651 S	10/2012	Kim et al.	
D669,070 S	10/2012	Hsu et al.	
D669,468 S	10/2012	Akana et al.	
D669,469 S	10/2012	Kang	
D670,286 S	11/2012	Akana et al.	
D670,692 S	11/2012	Akana et al.	
D671,111 S	11/2012	Kim et al.	
D671,514 S	11/2012	Kim et al.	
D671,536 S	11/2012	Fukasawa et al.	
D671,538 S	11/2012	Kim et al.	
D671,539 S	11/2012	Kim et al.	
D672,344 S	12/2012	Li	
D672,345 S	12/2012	Li	
D672,768 S	12/2012	Huang et al.	
D673,561 S	1/2013	Hyun et al.	
D673,950 S	1/2013	Li et al.	
D674,384 S	1/2013	Zhang	
D675,203 S	1/2013	Yang	
D676,538 S	2/2013	Fehring	
D677,181 S	3/2013	Lenz et al.	
D677,255 S	3/2013	McManigal et al.	
D677,660 S	3/2013	Groene et al.	
D678,271 S	3/2013	Chiu	
D680,533 S	4/2013	Song et al.	
D682,264 S	5/2013	Kim et al.	
D682,821 S	5/2013	Kim et al.	
D682,822 S	5/2013	Kim et al.	

(56)

**References Cited**

## U.S. PATENT DOCUMENTS

D682,823	S	5/2013	Park et al.
D682,824	S	5/2013	Kim et al.
D682,825	S	5/2013	Kim et al.
D682,826	S	5/2013	Kim et al.
D682,827	S	5/2013	Park et al.
D682,828	S	5/2013	Kim et al.
D686,202	S	7/2013	Lee et al.
D686,203	S	7/2013	Lee et al.
2003/0048595	A1	3/2003	Hsieh et al.
2003/0151888	A1	8/2003	Chien et al.
2005/0018396	A1	1/2005	Nakajima et al.
2005/0041378	A1	2/2005	Hamada et al.
2005/0044665	A1*	3/2005	Kuramochi ..... 16/341
2009/0231292	A1	9/2009	Hsieh et al.
2011/0074740	A1	3/2011	Liu
2011/0294555	A1	12/2011	Happonen et al.
2012/0092195	A1	4/2012	Lin

## FOREIGN PATENT DOCUMENTS

KR	3005639120000	6/2010
KR	3005639130000	6/2010
KR	3005680110000	7/2010
KR	3005804720000	11/2010
KR	3005869900000	1/2011
KR	3005942330000	3/2011
KR	3005958550000	4/2011
KR	3005985190000	5/2011
KR	3005994750000	5/2011
KR	3006004150000	5/2011
KR	3006004300000	5/2011
KR	3006013110001	6/2011
KR	3006013130000	6/2011
KR	3006013160000	6/2011
KR	3006013170000	6/2011
KR	3006046440000	7/2011
KR	3006052790000	7/2011
KR	3006052810000	7/2011
KR	3006052820000	7/2011
KR	3006052830000	7/2011
KR	3006059710000	7/2011
KR	3006063210000	7/2011
KR	3006064090000	7/2011
KR	3006083610000	8/2011
KR	3006083630000	8/2011
KR	3006083640000	8/2011
KR	3006083650000	8/2011
KR	3006083710000	8/2011
KR	3006083730000	8/2011
KR	3006085180000	8/2011

## OTHER PUBLICATIONS

Design U.S. Appl. No. 29/457,871 Inventor: Son-Young Lee, et al., filed Jun. 13, 2013 entitled Display for a Portable Computer.  
 Design U.S. Appl. No. 29/457,873 Inventor: Son-Young Lee, et al., filed Jun. 13, 2013 entitled Portable Computer.  
 Design U.S. Appl. No. 29/457,874 Inventor: Won-Suk Chung, et al., filed Jun. 13, 2013 entitled Body of Portable Computer.  
 Design U.S. Appl. No. 29/457,875 Inventor: Son-Young Lee, et al., filed Jun. 13, 2013 entitled Display for a Portable Computer.  
 Design U.S. Appl. No. 29/458,186 Inventor: Ji-Eun Myung, et al., filed Jun. 28, 2013 entitled Portable Computer.  
 Design U.S. Appl. No. 29/458,191 Inventor: Ji-Eun Myung, et al., filed Jun. 28, 2013 entitled Portable Computer.  
 Design U.S. Appl. No. 29/458,200 Inventor: Ji-Eun Myung, et al., filed Jun. 28, 2013 entitled Body of Portable Computer.  
 Design U.S. Appl. No. 29/458,204 Inventor: Ji-Eun Myung, et al., filed Jun. 28, 2013 entitled Portable Computer.  
 Design U.S. Appl. No. 29/458,206 Inventor: Ji-Eun Myung, et al., filed Jun. 28, 2013 entitled Body of Portable Computer.  
 Design U.S. Appl. No. 29/458,207 Inventor: Ji-Eun Myung, et al., filed Jun. 28, 2013 entitled Display for a Portable Computer.

Design U.S. Appl. No. 29/458,277 Inventor: Ji-Eun Myung, et al., filed Jun. 28, 2013 entitled Display for a Portable Computer.  
 Design U.S. Appl. No. 29/458,285 Inventor: Ji-Eun Myung, et al., filed Jun. 28, 2013 entitled Display for a Portable Computer.  
 Design U.S. Appl. No. 29/458,289 Inventor: Ji-Eun Myung, et al., filed Jun. 28, 2013 entitled Body of Portable Computer.  
 Design U.S. Appl. No. 29/458,290 Inventor: Ji-Eun Myung, et al., filed Jun. 28, 2013 entitled Display for a Portable Computer.  
 Design U.S. Appl. No. 29/452,596 Inventor: Son-Young Lee, et al., filed Apr. 18, 2013 entitled Portable Computer.  
 Design U.S. Appl. No. 29/405,537 Applicant: Ik-Sang Kim, et al., filed Nov. 3, 2011 entitled Tablet Computer.  
 Design U.S. Appl. No. 29/407,975 Applicant: Bum-Ho Chun, et al., filed Dec. 6, 2011 entitled Tablet Computer.  
 Design U.S. Appl. No. 29/407,982 Applicant: Eunuashally Lee, et al., filed Dec. 6, 2011 entitled Tablet Computer.  
 Design U.S. Appl. No. 29/407,984 Applicant: So-Yoon Jeon, et al., filed Dec. 6, 2011 entitled Tablet Computer.  
 Design U.S. Appl. No. 29/408,017 Applicant: Jae-Seung Song, et al., filed Dec. 6, 2011 entitled Tablet Computer.  
 Design U.S. Appl. No. 29/416,029 Applicant: Min-Jung Kim, et al., filed Mar. 16, 2012 entitled Tablet Computer.  
 Design U.S. Appl. No. 29/416,032 Applicant: Min-Jung Kim, et al., filed Mar. 16, 2012 entitled Tablet Computer.  
 Design U.S. Appl. No. 29/418,670 Applicant: Byeong-Yong Song, et al., filed Apr. 19, 2012 entitled Tablet Computer.  
 Design U.S. Appl. No. 29/419,893 Applicant: Ik-Sang Kim, et al., filed May 2, 2012 entitled Slate Computer.  
 Design U.S. Appl. No. 29/419,907 Applicant: Ik-Sang Kim, et al., filed May 2, 2012 entitled Slate Computer.  
 Design U.S. Appl. No. 29/419,911 Applicant: Min-Jung Kim, et al., filed May 2, 2012 entitled Tablet Computer.  
 Design U.S. Appl. No. 29/420,669 Applicant: Woo-Teik Lim, et al., filed May 11, 2012 entitled Tablet Computer.  
 Design U.S. Appl. No. 29/422,581 Applicant: Jung-Hyun Park, et al., filed May 22, 2012 entitled Notebook Computer.  
 Design U.S. Appl. No. 29/422,594 Applicant: Jung-Hyun Park, et al., filed May 22, 2012 entitled Notebook Computer.  
 Design U.S. Appl. No. 29/422,779 Applicant: Tae-Yun Kim, et al., filed May 23, 2012 entitled Notebook Computer.  
 Design U.S. Appl. No. 29/424,453 Applicant: Se-O Lee, et al., filed Jun. 12, 2012 entitled Notebook Computer.  
 Design U.S. Appl. No. 29/424,462 Applicant: Sang-Eun Lee, et al., filed Jun. 12, 2012 entitled Netbook Computer.  
 Design U.S. Appl. No. 29/425,225 Applicant: Seung-Ho Jung, et al., filed Jun. 20, 2012 entitled Portable Computer.  
 Design U.S. Appl. No. 29/425,732 Applicant: Ji-Sang Park, et al., filed Jun. 26, 2012 entitled Portable Computer.  
 Design U.S. Appl. No. 29/425,977 Applicant: Ji-Sang Park, et al., filed Jun. 28, 2012 entitled Tablet Computer.  
 Design U.S. Appl. No. 29/425,978 Applicant: Woo-Teik Lim, et al., filed Jun. 28, 2012 entitled Tablet Computer.  
 Design U.S. Appl. No. 29/427,736 Applicant: Min-Jung Kim, et al., filed Jul. 21, 2012 entitled Tablet Computer.  
 Design U.S. Appl. No. 29/431,774 Applicant: Sang-Eun Lee, et al., filed Sep. 11, 2012 entitled Tablet Computer.  
 Design U.S. Appl. No. 29/435,870 Inventor: Son-Young Lee, et al., filed Oct. 30, 2012 entitled Portable Computer.  
 Design U.S. Appl. No. 29/435,889 Inventor: Dong-Seok Lee, et al., filed Oct. 30, 2012 entitled Portable Computer.  
 Design U.S. Appl. No. 29/438,934 Inventor: Ik-Sang Kim, et al., filed Dec. 5, 2012 entitled Slate Computer.  
 Design U.S. Appl. No. 29/438,948 Inventor: Chung-Ha Kim, et al., filed Dec. 5, 2012 entitled Portable Computer.  
 Design U.S. Appl. No. 29/438,951 Inventor: Chung-Ha Kim, et al., filed Dec. 5, 2012 entitled Portable Computer.  
 Design U.S. Appl. No. 29/441,093 Inventor: Chang-Ho Lee, et al., filed Dec. 31, 2012 entitled Portable Computer.  
 Design U.S. Appl. No. 29/441,101 Inventor: Chang-Ho Lee, et al., filed Dec. 31, 2012 entitled Portable Computer.  
 Design U.S. Appl. No. 29/441,112 Inventor: Chang-Ho Lee, et al., filed Dec. 31, 2012 entitled Portable Computer.

(56)

**References Cited**

OTHER PUBLICATIONS

Design U.S. Appl. No. 29/441,114 Inventor: Chang-Ho Lee, et al., filed Dec. 31, 2012 entitled Portable Computer.  
Design U.S. Appl. No. 29/441,179 Inventor: Chang-Ho Lee, et al., filed Jan. 2, 2013 entitled Portable Computer.  
Design U.S. Appl. No. 29/452,297 Inventor: Min-Hee Lee, et al., filed Apr. 15, 2013 entitled Notebook Computer.  
Design U.S. Appl. No. 29/452,583 Inventor: Seung-Ho Jung, et al., filed Apr. 18, 2013 entitled Portable Computer.  
Design U.S. Appl. No. 29/452,586 Inventor: Seung-Ho Jung, et al., filed Apr. 18, 2013 entitled Portable Computer.  
Design U.S. Appl. No. 29/452,588 Inventor: Chung-Ha Kim, et al., filed Apr. 18, 2013 entitled Portable Computer.  
Design U.S. Appl. No. 29/452,592 Inventor: Son-Young Lee, et al., filed Apr. 18, 2013 entitled Portable Computer.  
Design U.S. Appl. No. 29/452,593 Inventor: Woo-Teik Lim, et al., filed Apr. 18, 2013 entitled Slate Computer.  
Design U.S. Appl. No. 29/452,594 Inventor: Son-Young Lee, et al., filed Apr. 18, 2013 entitled Portable Computer.

Design U.S. Appl. No. 29/452,595 Inventor: Ho-Young Seoc, et al., filed Apr. 18, 2013 entitled Slate Computer.  
Design U.S. Appl. No. 29/452,601 Inventor: Ji-Sang Park, et al., filed Apr. 18, 2013 entitled Portable Computer.  
Design U.S. Appl. No. 29/456,501 Inventor: Se-Hun Oh, et al., filed May 31, 2013 entitled Portable Computer.  
Design U.S. Appl. No. 29/457,839 Inventor: Son-Young Lee, et al., filed Jun. 13, 2013 entitled Portable Computer.  
Design U.S. Appl. No. 29/457,846 Inventor: Son-Young Lee, et al., filed Jun. 13, 2013 entitled Body of Portable Computer.  
Design U.S. Appl. No. 29/457,848 Inventor: Son-Young Lee, et al., filed Jun. 13, 2013 entitled Portable Computer.  
Design U.S. Appl. No. 29/457,852 Inventor: Son-Young Lee, et al., filed Jun. 13, 2013 entitled Body of Portable Computer.  
Design U.S. Appl. No. 29/457,859 Inventor: Son-Young Lee, et al., filed Jun. 13, 2013 entitled Portable Computer.  
Design U.S. Appl. No. 29/457,864 Inventor: Son-Young Lee, et al., filed Jun. 13, 2013 entitled Portable Computer.  
Design U.S. Appl. No. 29/452,587 Inventor: Sung-Jin Yum, et al., filed Apr. 18, 2013 entitled Portable Computer.

\* cited by examiner

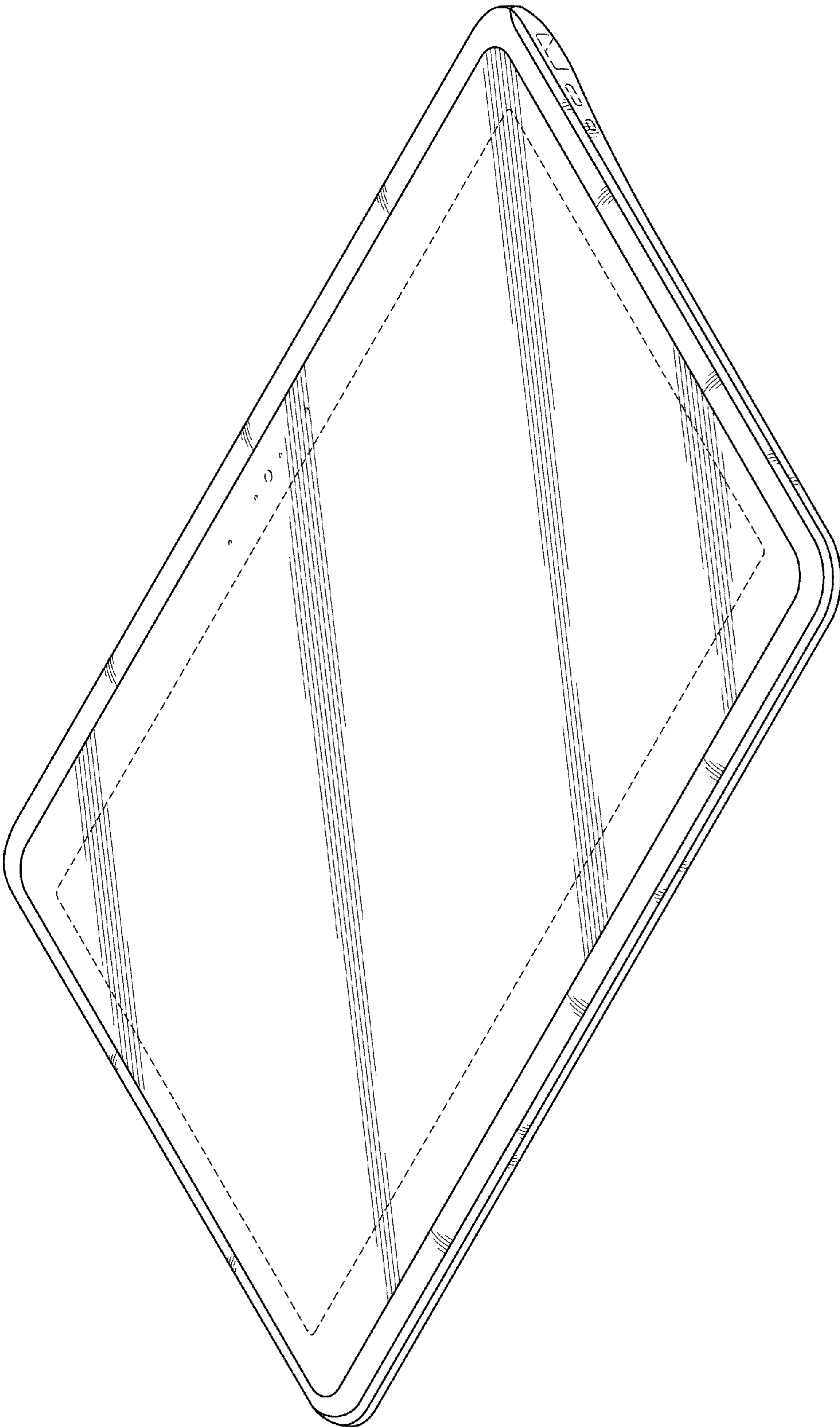

FIG.1

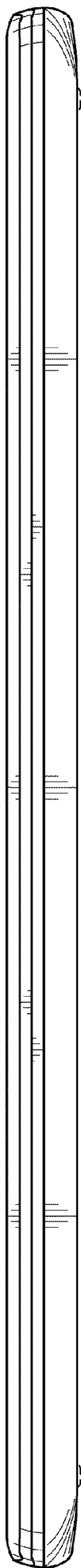

FIG. 2

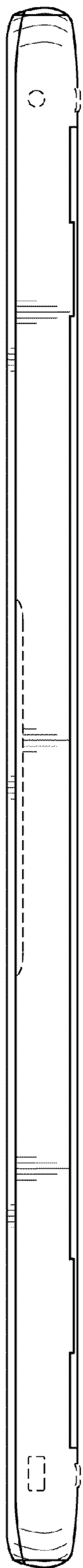

FIG. 3

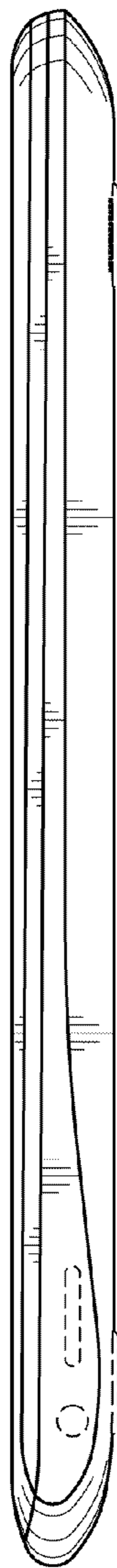

FIG. 4

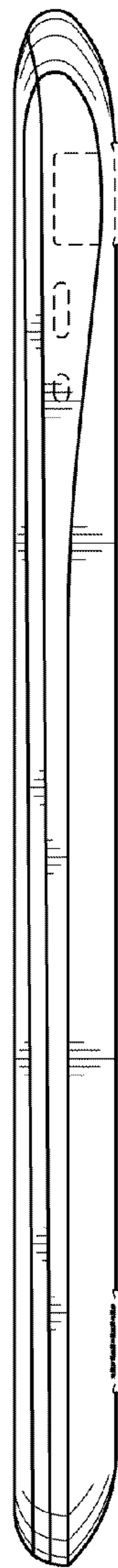

FIG. 5

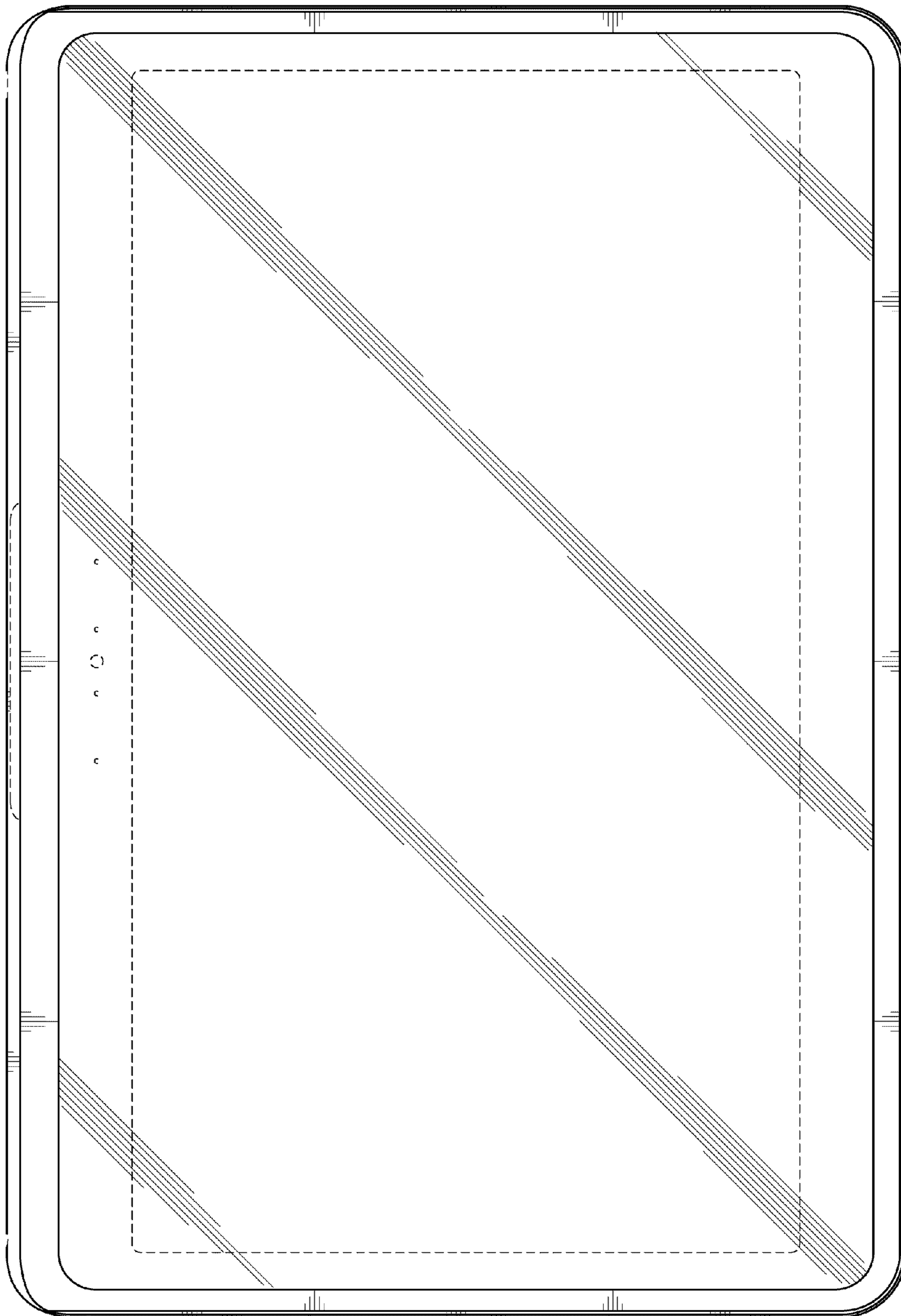

FIG.6

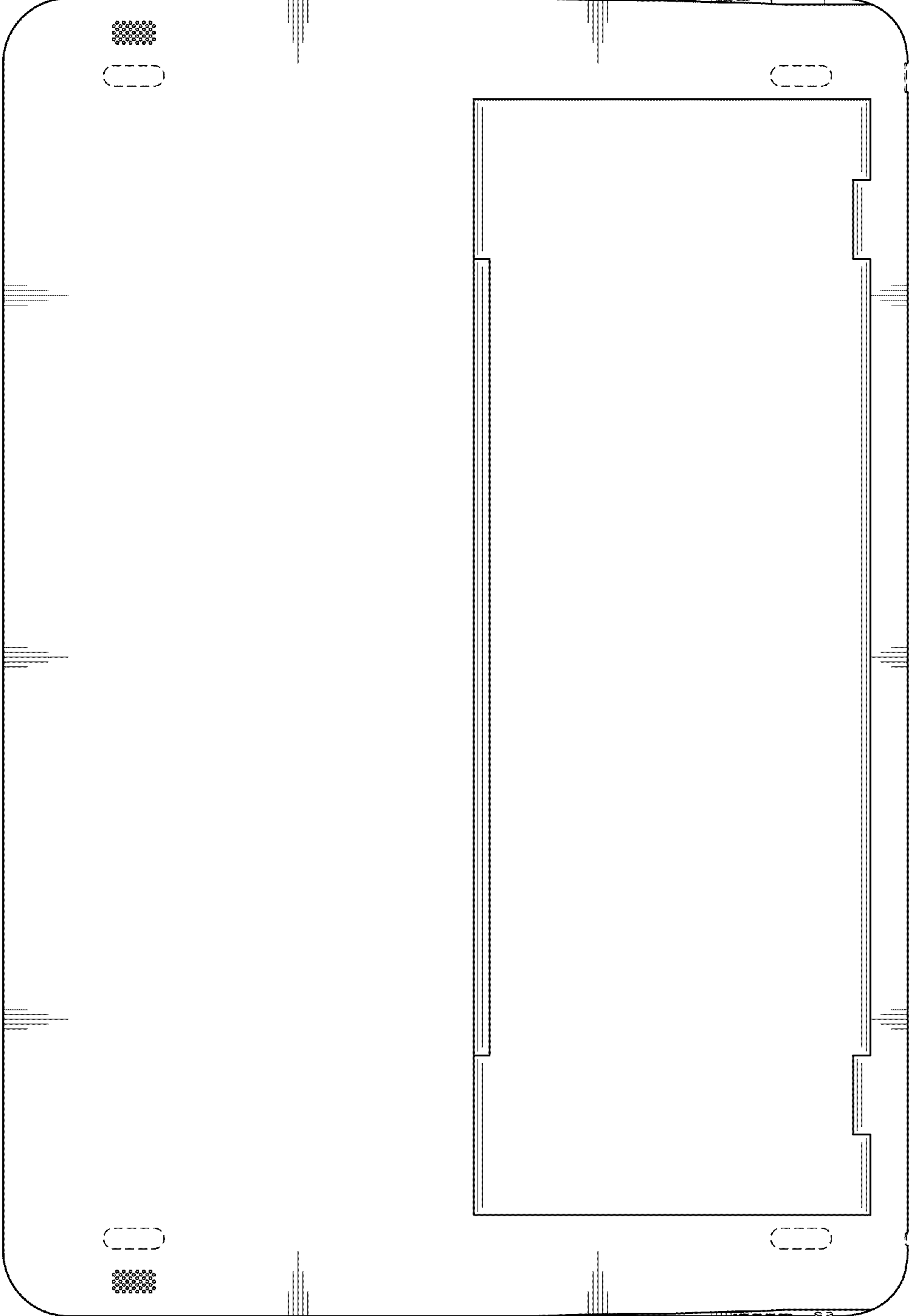

FIG.7



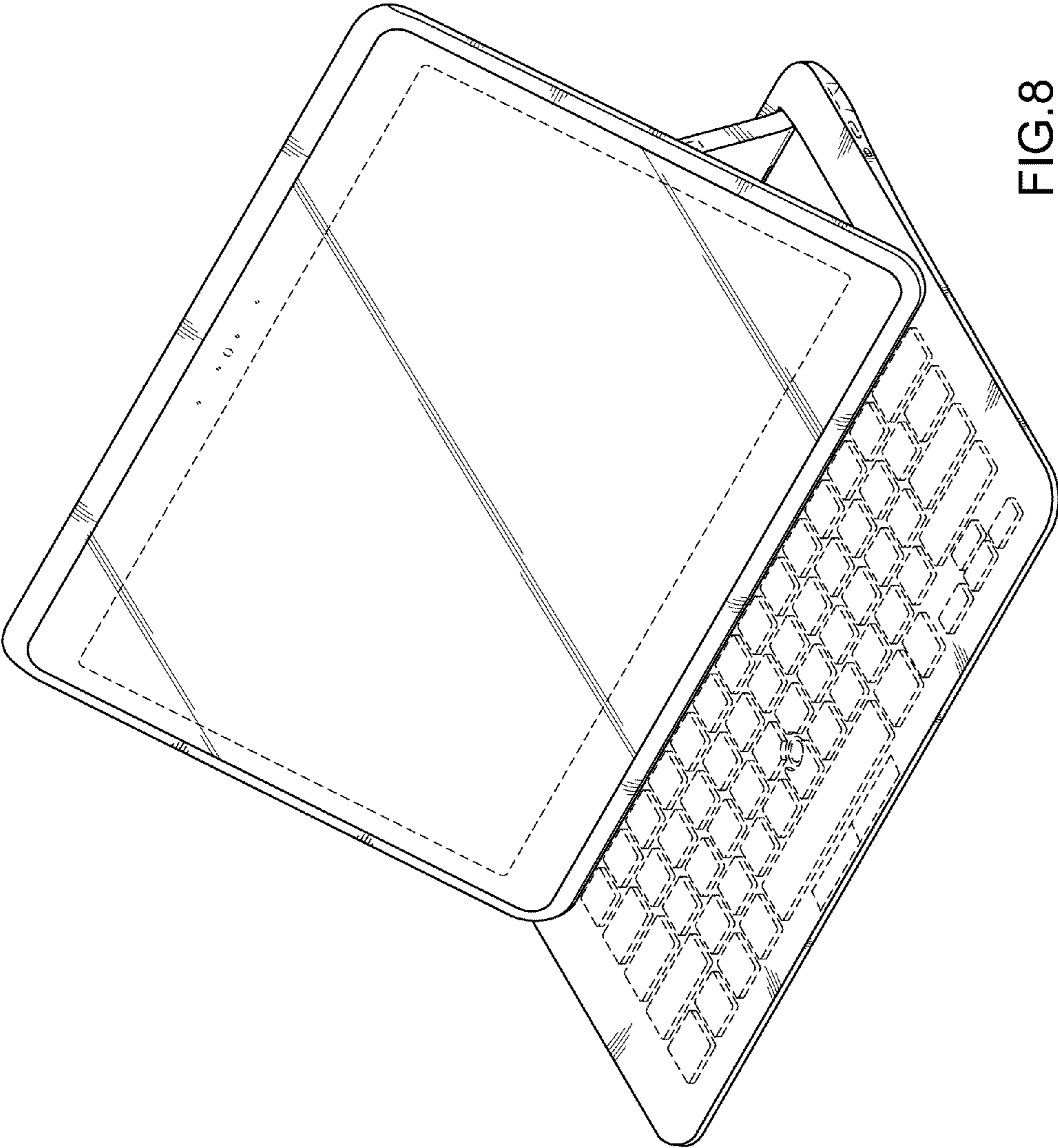

FIG.8

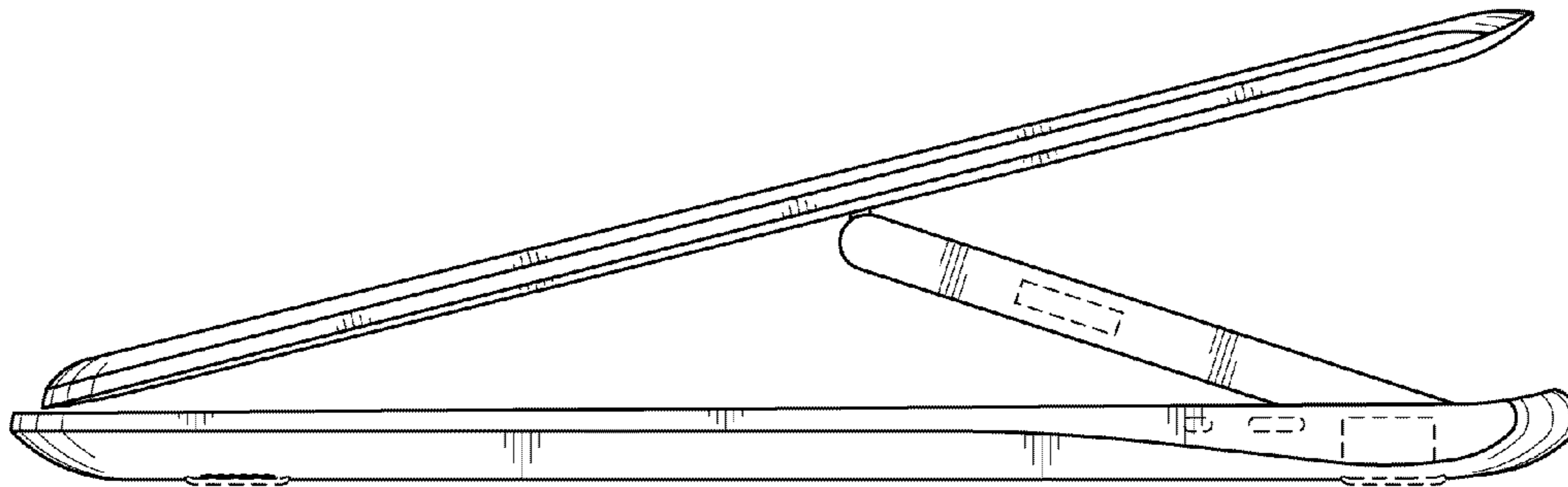

FIG. 9

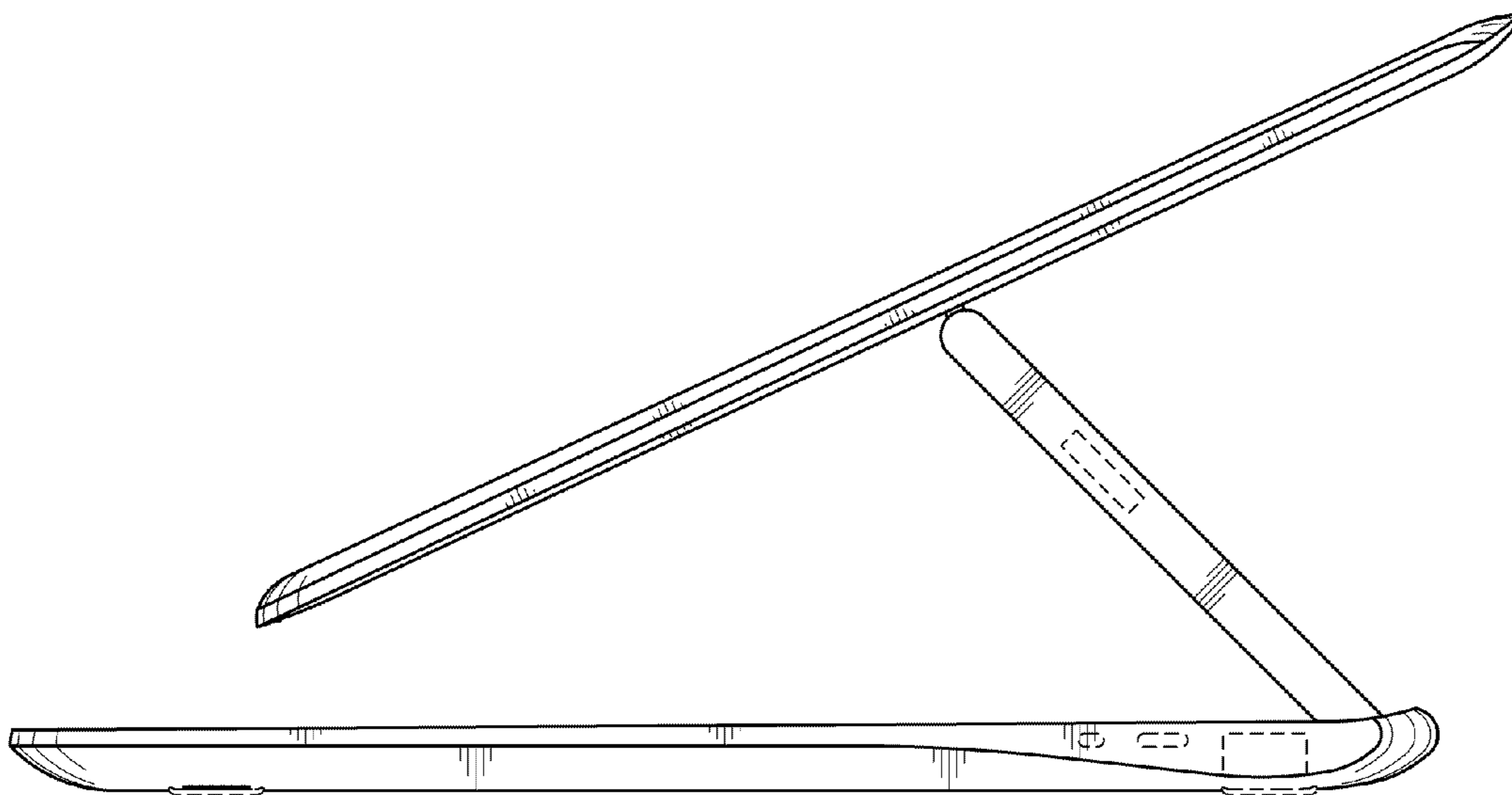

FIG. 10

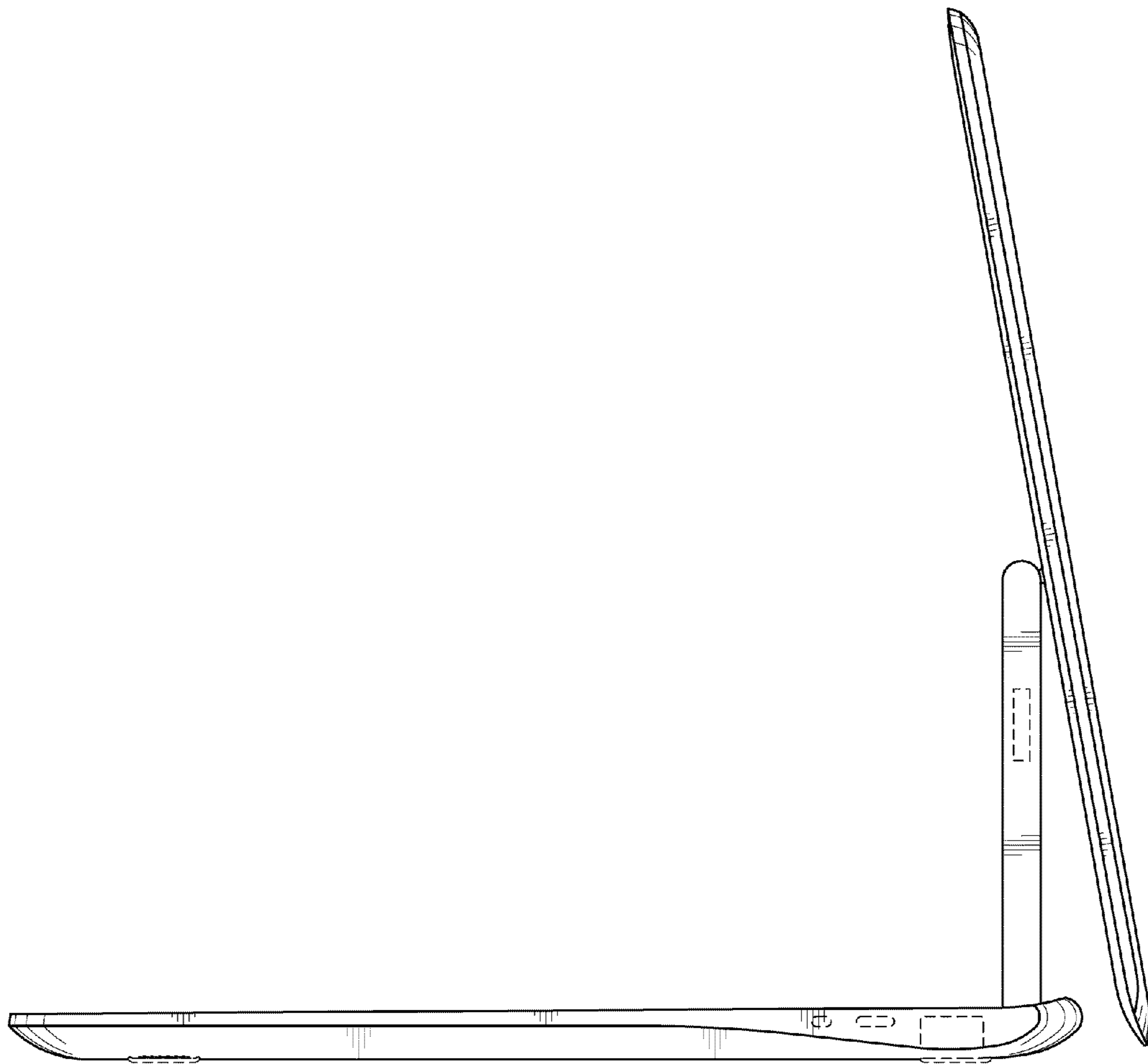

FIG. 11