



US00D721692S

(12) **United States Design Patent**
Kim et al.

(10) **Patent No.:** **US D721,692 S**
(45) **Date of Patent:** **** Jan. 27, 2015**

(54) **CASE FOR CELLULAR PHONE**

(71) Applicant: **LG Electronics Inc.**, Seoul (KR)

(72) Inventors: **Hongsik Kim**, Gyeonggi-do (KR);
Hyunjin Yoon, Gyeonggi-do (KR)

(73) Assignee: **LG Electronics Inc.**, Seoul (KR)

(**) Term: **14 Years**

(21) Appl. No.: **29/481,292**

(22) Filed: **Feb. 4, 2014**

(30) **Foreign Application Priority Data**

Aug. 7, 2013 (KR) 30-2013-0040821

(51) **LOC (10) Cl.** **14-03**

(52) **U.S. Cl.**
USPC **D14/250**

(58) **Field of Classification Search**
USPC D14/250, 238.1, 440, 203.3–203.7, 217,
D14/240, 248, 251–253, 341–347, 444, 447,
D14/496; D13/103, 107–108, 119;
248/176.3, 188.8, 309.1, 371, 668;
361/220, 379.01, 679.01, 679.02,
361/679.09, 679.21, 679.25, 679.3, 679.4,
361/679.56, 679.57, 759, 807, 816;
379/433.11, 451, 455; 455/556.1, 557,
455/566, 575.1, 575.2, 575.8; 206/37, 45.2,
206/305, 320, 216; 320/108, 115; 429/96;
220/4.02; 150/165; 174/50; 235/41,
235/375, 462; 312/223.1; 396/535; D3/201,
D3/218, 247, 269, 272, 301, 303

See application file for complete search history.

(56) **References Cited**

U.S. PATENT DOCUMENTS

6,616,111 B1 * 9/2003 White 248/309.1
D521,232 S * 5/2006 Andre et al. D3/218

D539,290 S * 3/2007 Zhu et al. D14/447
D543,541 S * 5/2007 Chung et al. D3/269
D553,352 S * 10/2007 Allen D3/218
D639,815 S * 6/2011 Lye D14/447
D640,679 S * 6/2011 Willes et al. D14/250
D644,428 S * 9/2011 Feng D3/218
D645,462 S * 9/2011 Choi D14/253
D657,137 S * 4/2012 Weller et al. D3/218
D661,646 S * 6/2012 Son D13/108
D668,247 S * 10/2012 Kim et al. D14/253
D669,459 S * 10/2012 Kim D14/253
D674,803 S * 1/2013 Westrup D14/440
D678,298 S * 3/2013 Burrige D14/447
D683,954 S * 6/2013 Izen et al. D3/218
D685,990 S * 7/2013 Zhang D3/218
D689,058 S * 9/2013 Waterman D14/447
D691,991 S * 10/2013 Mohan D14/250
2014/0076745 A1 * 3/2014 NG 206/37

* cited by examiner

Primary Examiner — Carla Jobe Wright

(74) *Attorney, Agent, or Firm* — Morgan, Lewis & Bockius LLP

(57) **CLAIM**

The ornamental design for a case for cellular phone, as shown and described.

DESCRIPTION

FIG. 1 is a front, right side, perspective view of a case for cellular phone showing our new design;
FIG. 2 is a front view thereof;
FIG. 3 is a rear view thereof;
FIG. 4 is a left side view thereof;
FIG. 5 is a right side view thereof;
FIG. 6 is a top view thereof;
FIG. 7 is a bottom view thereof; and,
FIG. 8 is a front perspective view thereof, showing the case for cellular phone in a state of use with an unclaimed cellular phone.

The broken lines in FIG. 8 depict an unclaimed cellular phone and form no part of the claimed design.

1 Claim, 7 Drawing Sheets

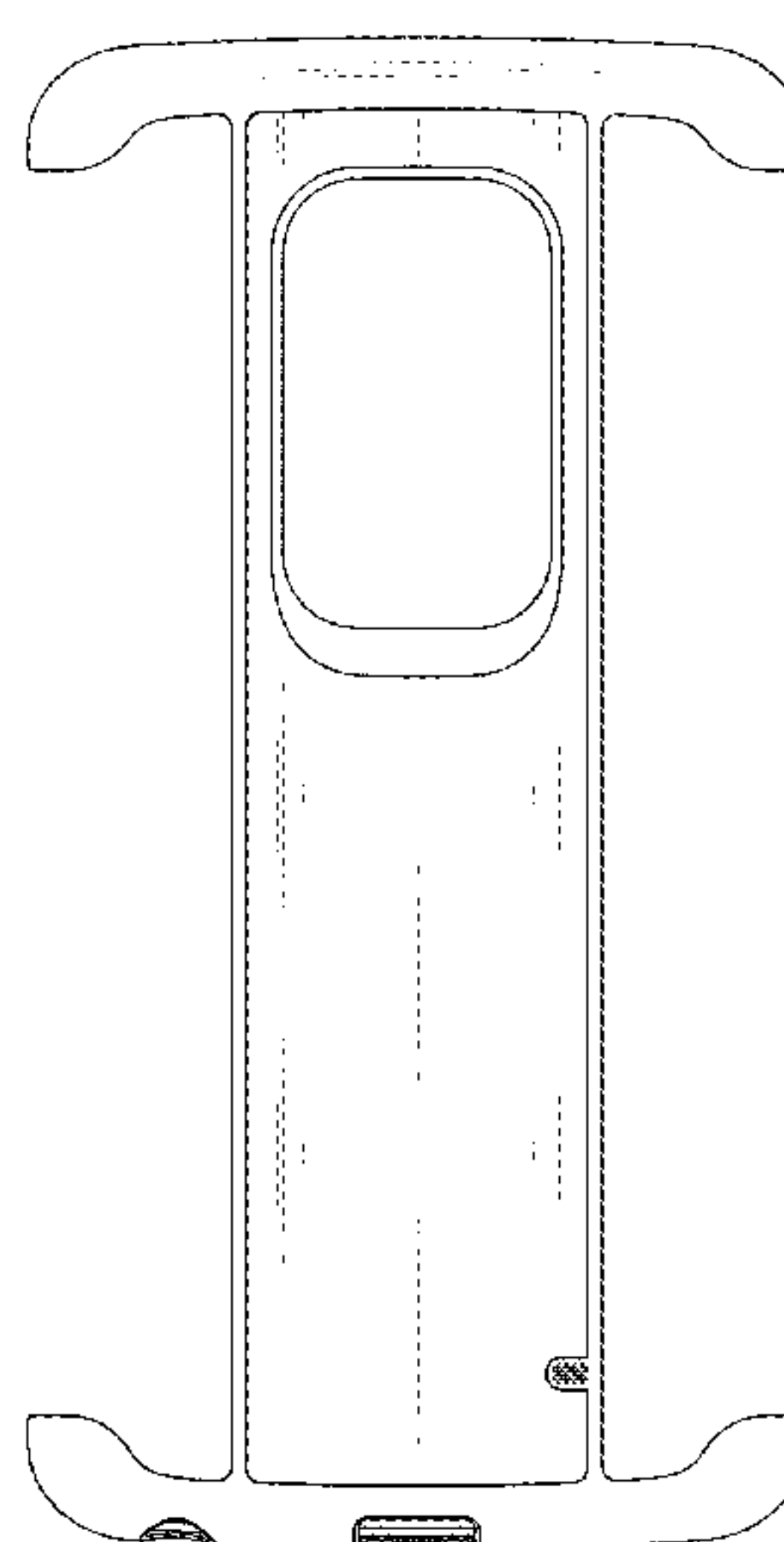
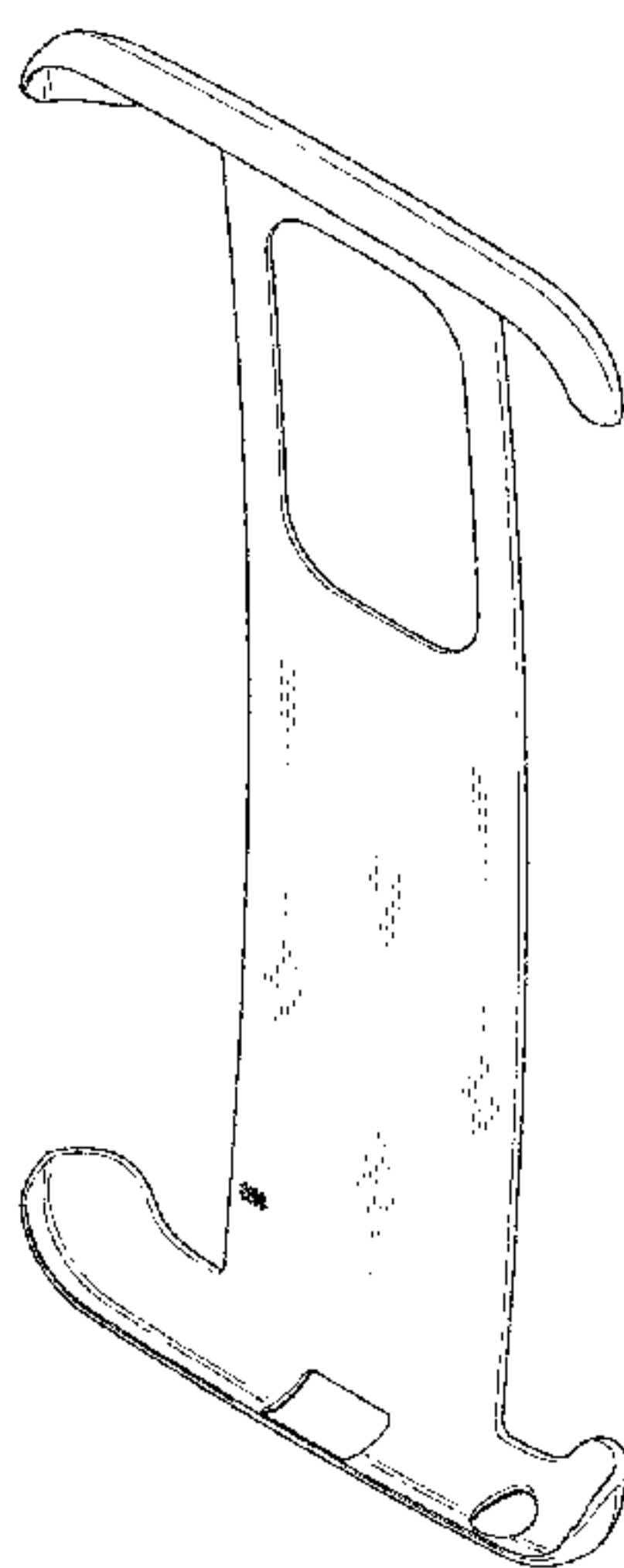

FIG. 1

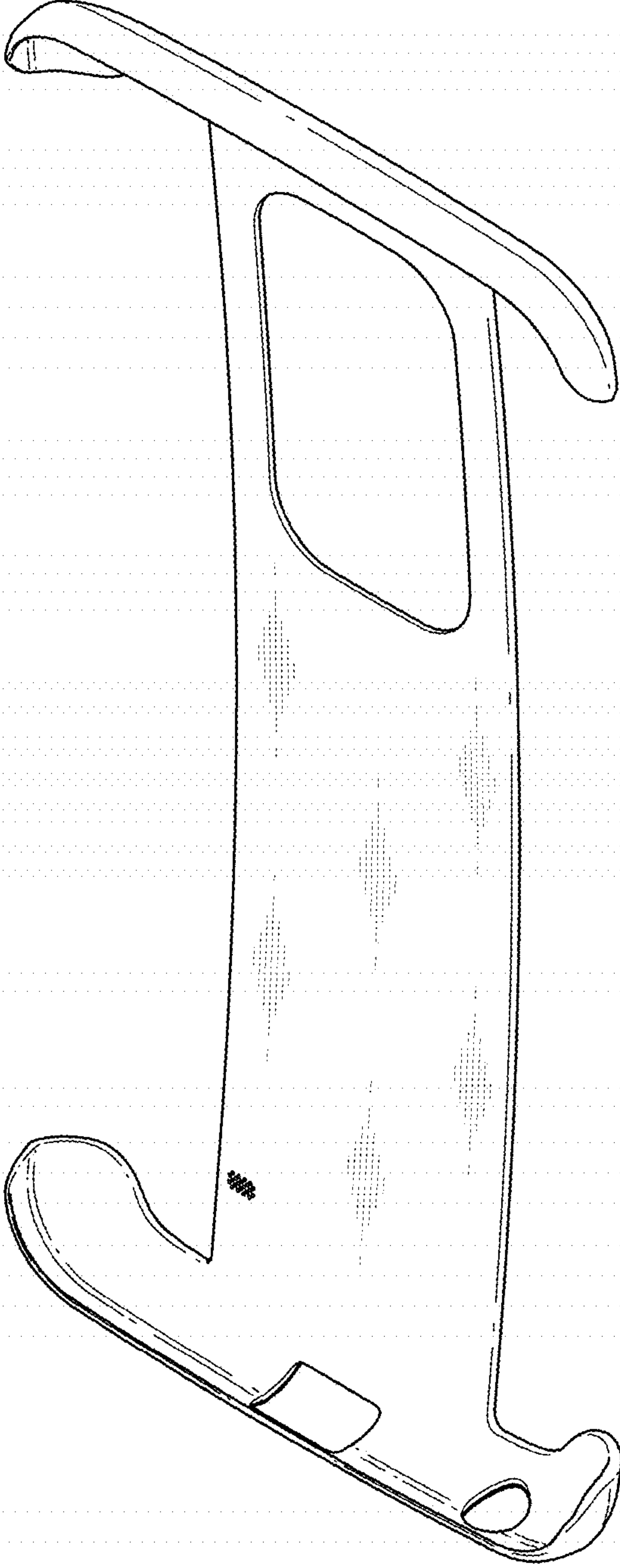

FIG. 2

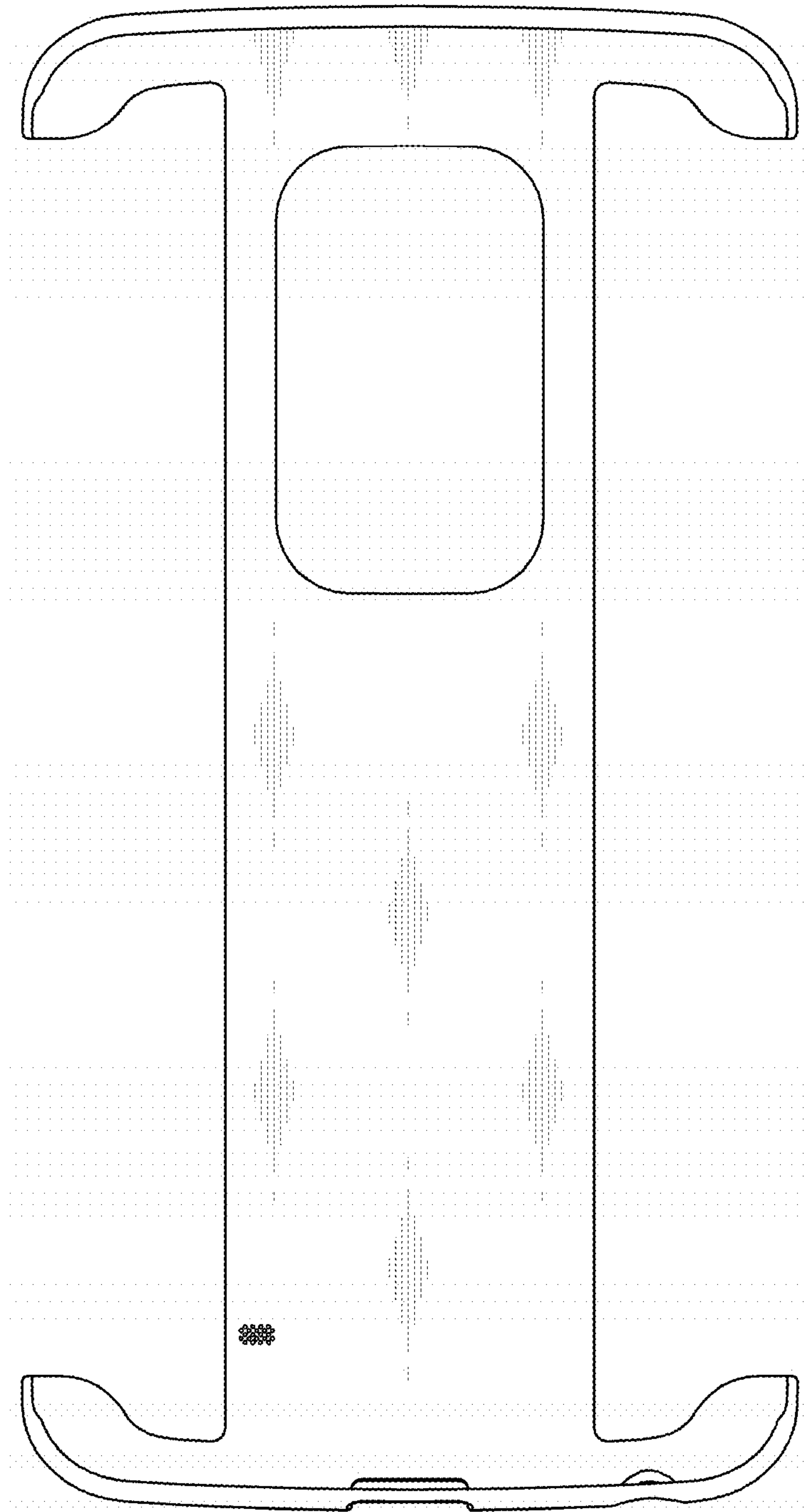

FIG. 3

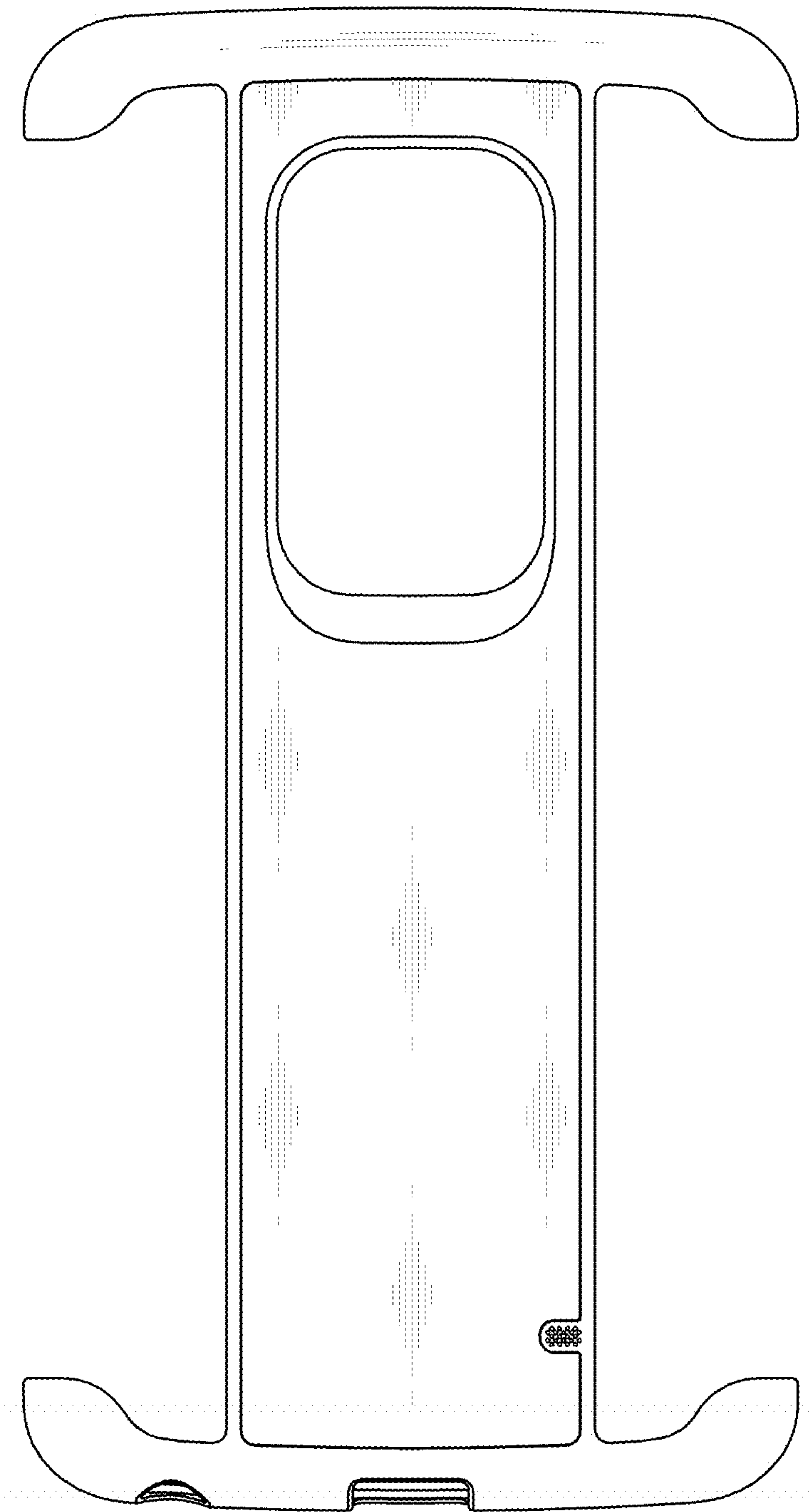

FIG. 4

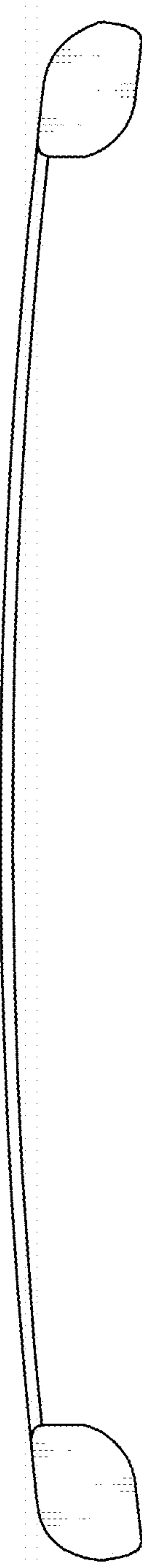

FIG. 5

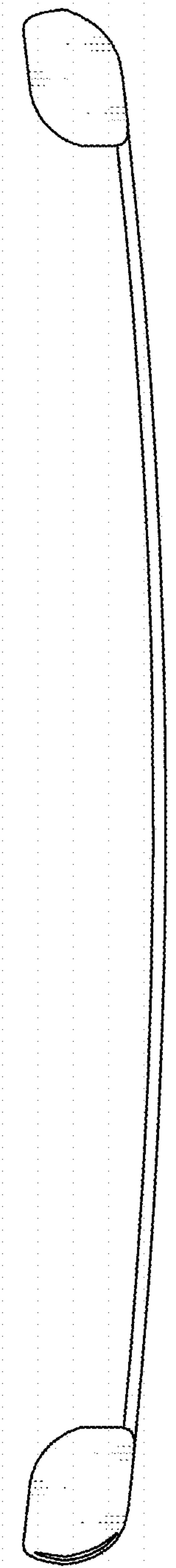

FIG. 6

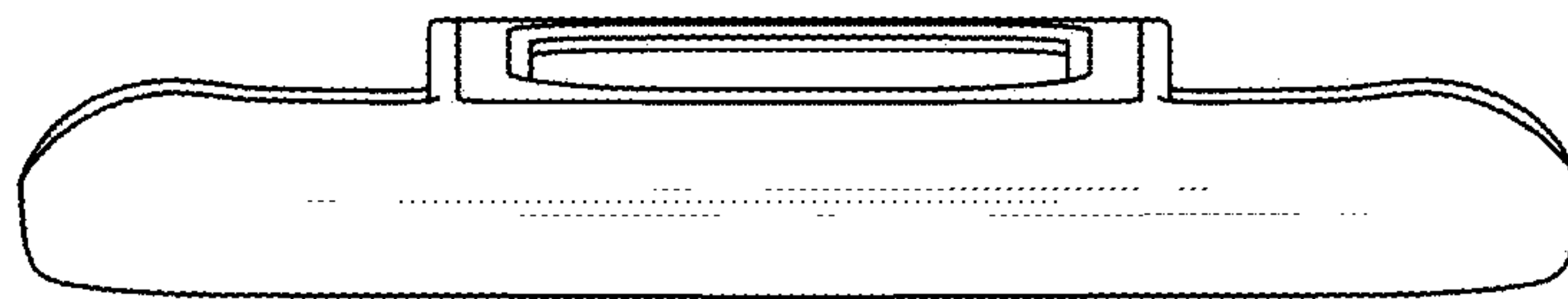

FIG. 7

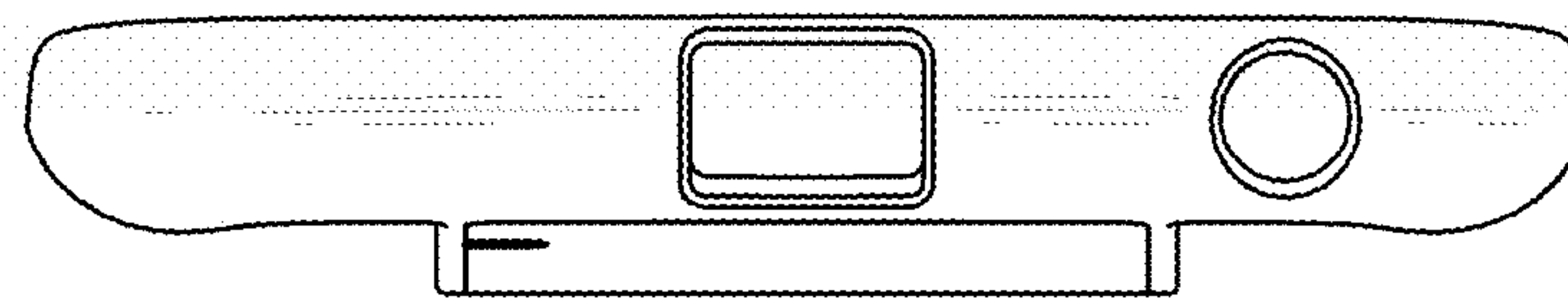

FIG. 8

