



US00D721691S

(12) **United States Design Patent**  
**Kim et al.**

(10) **Patent No.:** **US D721,691 S**  
(45) **Date of Patent:** **\*\* Jan. 27, 2015**

(54) **CASE FOR MOBILE PHONES**

(71) Applicant: **LG Electronics Inc.**, Seoul (KR)

(72) Inventors: **Hong Sik Kim**, Seoul (KR); **Hyun Jin Yoon**, Seoul (KR)

(73) Assignee: **LG Electronics Inc.**, Seoul (KR)

(\*\*) Term: **14 Years**

(21) Appl. No.: **29/478,988**

(22) Filed: **Jan. 10, 2014**

(30) **Foreign Application Priority Data**

Aug. 27, 2013 (KR) ..... 30-2013-0043944

(51) **LOC (10) Cl.** ..... **14-03**

(52) **U.S. Cl.**

USPC ..... **D14/250**

(58) **Field of Classification Search**

USPC ..... D14/250, 238.1, 440, 203.3–203.7, 217,  
D14/240, 248, 251–253, 341–347, 444, 447,  
D14/496; D13/103, 107–108, 119;  
248/176.3, 188.8, 309.1, 371, 668;  
361/220, 379.01, 679.01, 679.02,  
361/679.09, 679.21, 679.25, 679.3, 679.4,  
361/679.56, 679.57, 759, 807, 816;  
379/433.11, 451, 455; 455/556.1, 557,  
455/566, 575.1, 575.2, 575.8; 206/37, 45.2,  
206/305, 320, 216; 320/108, 115; 429/96;  
220/4.02; 150/165; 174/50; 235/41,  
235/375, 462; 312/223.1; 396/535; D3/201,  
D3/218, 247, 269, 272, 301, 303

See application file for complete search history.

(56) **References Cited**

U.S. PATENT DOCUMENTS

6,616,111 B1 \* 9/2003 White ..... 248/309.1  
D521,232 S \* 5/2006 Andre et al. .... D3/218  
D539,290 S \* 3/2007 Zhu et al. .... D14/447  
D543,541 S \* 5/2007 Chung et al. .... D3/269  
D553,352 S \* 10/2007 Allen ..... D3/218  
D639,815 S \* 6/2011 Lye ..... D14/447  
D640,679 S \* 6/2011 Willes et al. .... D14/250  
D644,428 S \* 9/2011 Feng ..... D3/218  
D645,462 S \* 9/2011 Choi ..... D14/253  
D657,137 S \* 4/2012 Weller et al. .... D3/218  
D661,646 S \* 6/2012 Son ..... D13/108  
D668,247 S \* 10/2012 Kim et al. .... D14/253  
D669,459 S \* 10/2012 Kim ..... D14/253  
D674,803 S \* 1/2013 Westrup ..... D14/440  
D678,298 S \* 3/2013 Burr ridge ..... D14/447  
D683,954 S \* 6/2013 Izen et al. .... D3/218  
D685,990 S \* 7/2013 Zhang ..... D3/218  
D689,058 S \* 9/2013 Waterman ..... D14/447  
D691,991 S \* 10/2013 Mohan ..... D14/250  
2014/0076745 A1 \* 3/2014 Ng ..... 206/37

\* cited by examiner

*Primary Examiner* — Carla Jobe Wright

(74) *Attorney, Agent, or Firm* — Morgan, Lewis & Bockius LLP

(57) **CLAIM**

We claim the ornamental design for a case for mobile phones, as shown and described.

**DESCRIPTION**

FIG. 1 is a perspective view of a case for mobile phones showing the new design:

FIG. 2 is a front elevation view thereof;

FIG. 3 is a rear elevation view thereof;

FIG. 4 is a left-side elevation view thereof;

FIG. 5 is a right-side elevation view thereof;

FIG. 6 is a top plan view thereof;

FIG. 7 is a bottom plan view thereof; and,

FIG. 8 is another perspective view thereof.

The broken lines in FIG. 8 depict unclaimed environment.

**1 Claim, 5 Drawing Sheets**

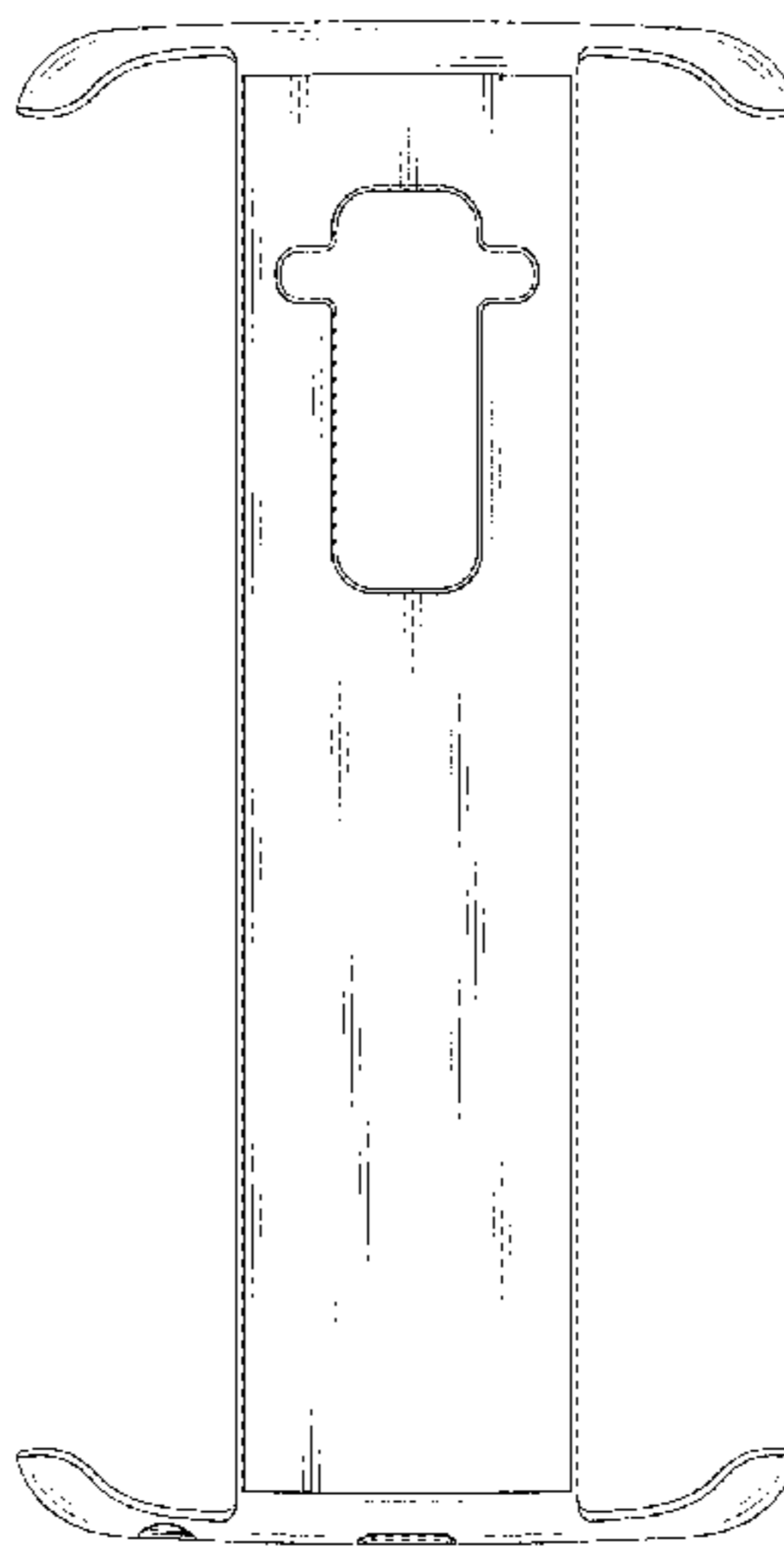
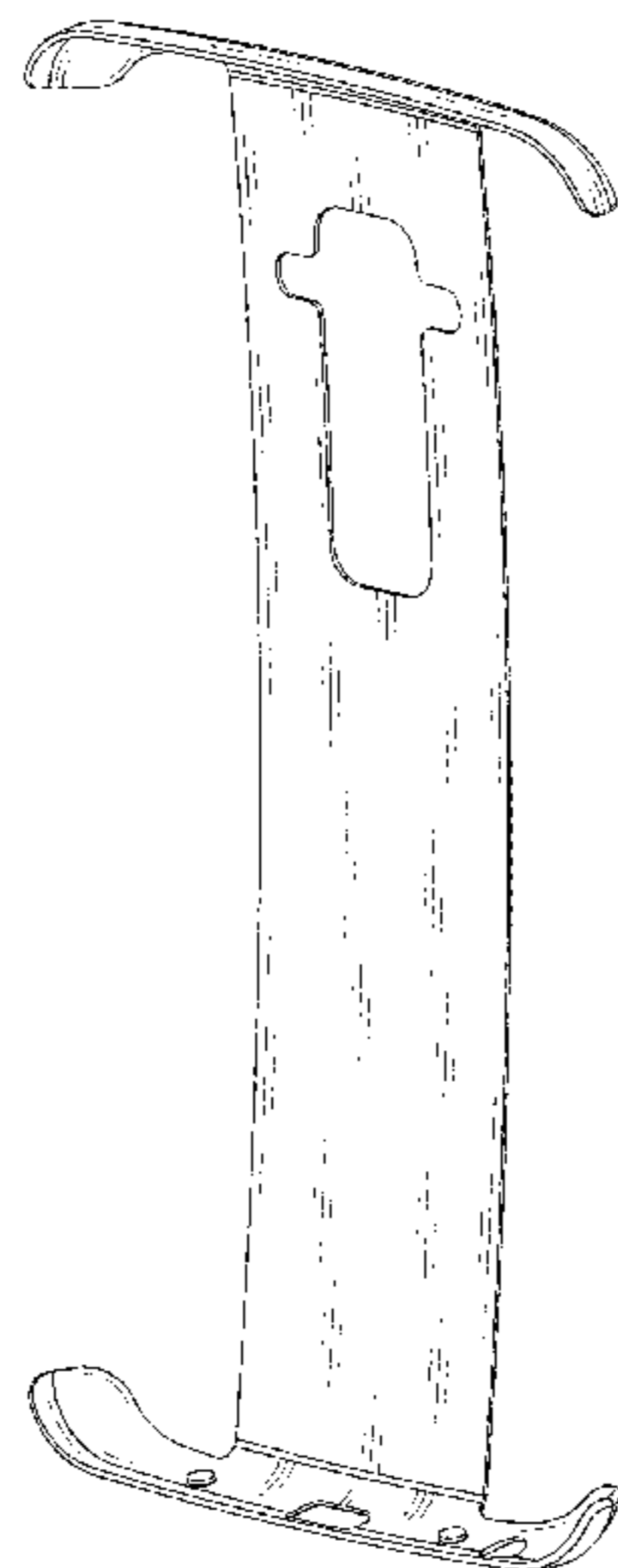

FIG. 1

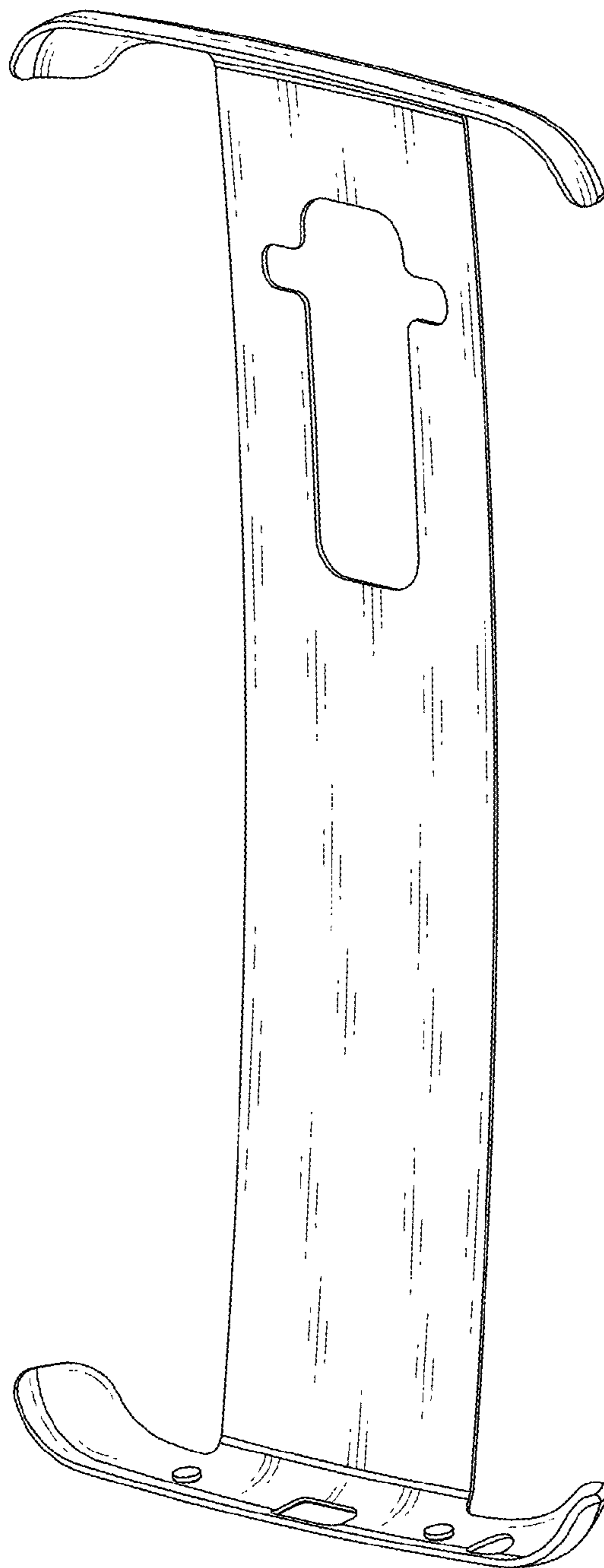

FIG.2

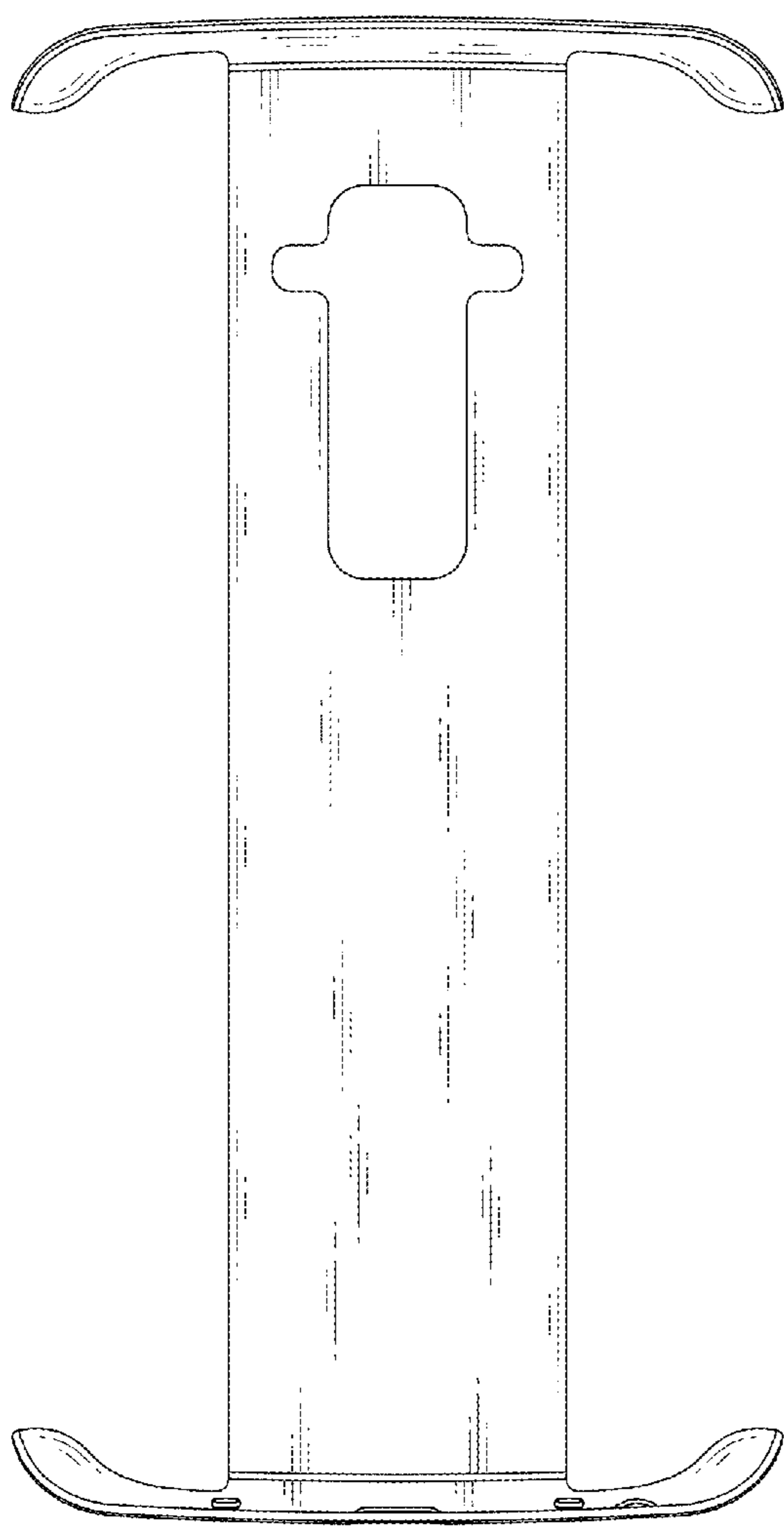

FIG.3

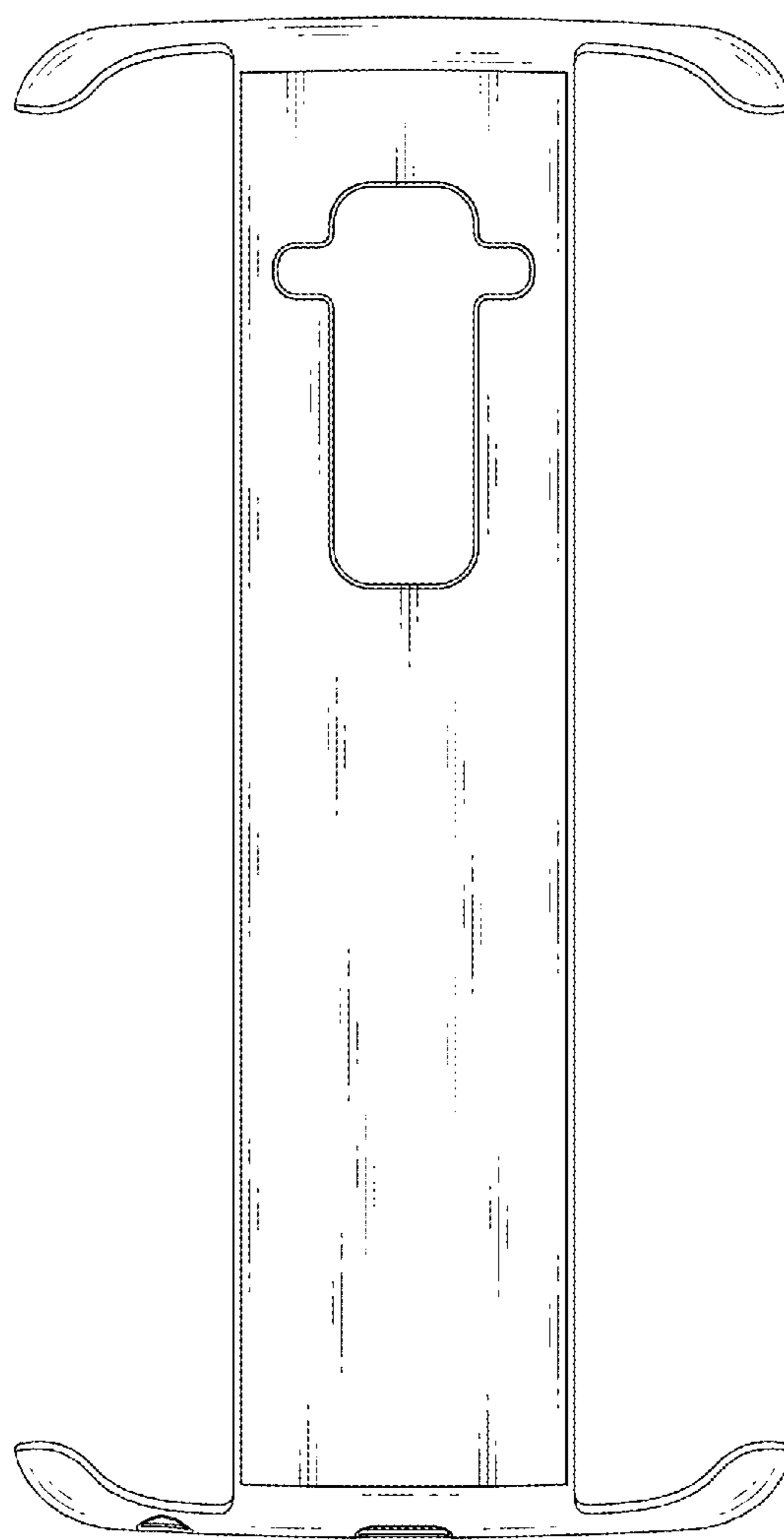

FIG. 4



FIG. 5



FIG. 6

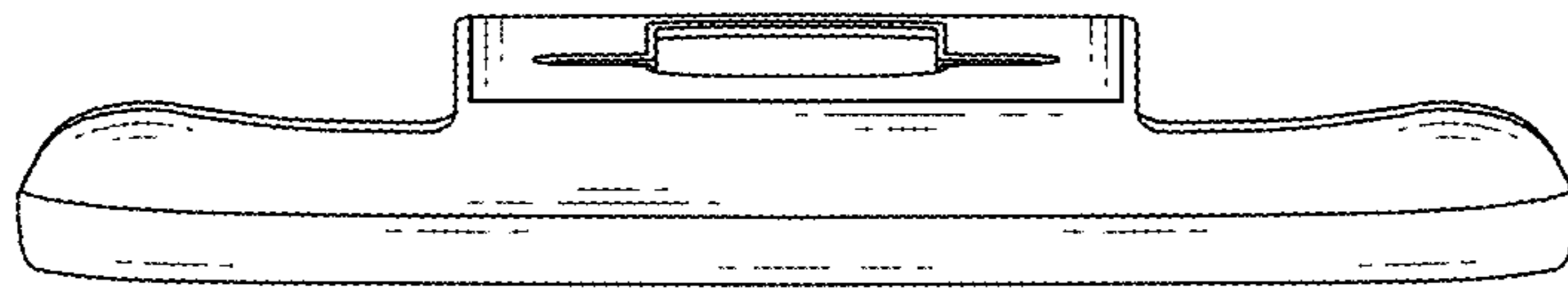

FIG. 7

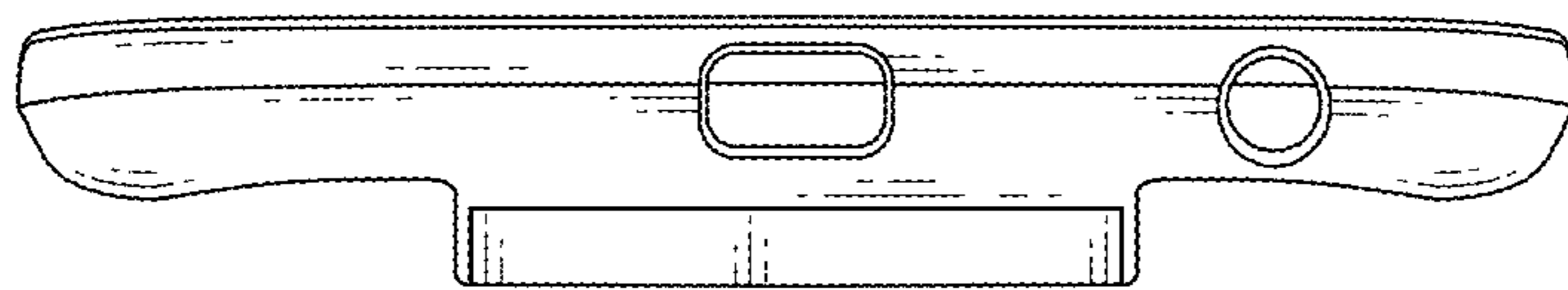

FIG. 8

