



US00D721604S

(12) **United States Design Patent**  
**Proper**

(10) **Patent No.:** **US D721,604 S**

(45) **Date of Patent:** **\*\* Jan. 27, 2015**

(54) **WORKPIECE ALIGNMENT AND POSITIONING DEVICE**

(71) Applicant: **George V. Proper**, Kitchener (CA)

(72) Inventor: **George V. Proper**, Kitchener (CA)

(\*\*) Term: **14 Years**

(21) Appl. No.: **29/470,260**

(22) Filed: **Oct. 18, 2013**

(51) **LOC (10) Cl.** ..... **10-04**

(52) **U.S. Cl.**  
USPC ..... **D10/65**

(58) **Field of Classification Search**  
CPC .. E04F 21/0007; E04F 21/22; E04G 21/1841;  
E04G 21/1883; E04G 21/1891; E04H 17/00;  
B25B 11/00; B25B 11/02; G01B 3/30; Y10S  
269/00; Y10S 269/904  
USPC ..... D10/65  
See application file for complete search history.

(56) **References Cited**

**U.S. PATENT DOCUMENTS**

2,601,630	A *	6/1952	Rahn et al.	451/41
3,686,703	A *	8/1972	Ray	15/235.4
4,625,415	A	12/1986	Diamontis	
4,662,618	A *	5/1987	Willis	269/43
4,843,726	A	7/1989	Ward	
5,286,951	A *	2/1994	Jones	219/521
5,784,850	A	7/1998	Elderson	
5,913,546	A	6/1999	Kuchenbrod et al.	
6,701,689	B2	3/2004	diGirolano	
7,726,037	B1	6/2010	Jordan	

D628,123	S *	11/2010	Kojima et al.	D11/221
7,979,997	B2	7/2011	Pianetto	
D667,322	S	9/2012	Madrack	
8,397,471	B2	3/2013	Jones	
2006/0010703	A1	1/2006	Gauthier	
2008/0022629	A1 *	1/2008	Behnecke et al.	52/750
2010/0083610	A1 *	4/2010	King	52/749.1
2011/0119944	A1	5/2011	McHowell	

\* cited by examiner

*Primary Examiner* — Antoine D Davis

(74) *Attorney, Agent, or Firm* — Robert C. Montgomery;  
Montgomery Patent & Design

(57) **CLAIM**

The ornamental design for a workpiece alignment and positioning device, as shown and described.

**DESCRIPTION**

FIG. 1 is a perspective view of a workpiece alignment and positioning device;  
FIG. 2 is a front view thereof, wherein a rear view is a mirror image of the front view;  
FIG. 3 is a left-hand side view thereof, wherein a right-hand side view is a mirror image of the left-hand side view;  
FIG. 4 is a top view thereof;  
FIG. 5 is a bottom view thereof; and,  
FIG. 6 is another perspective view of the workpiece alignment and positioning device with a handle depicted as part of the environment for illustration.  
The broken lines shown in the drawings illustrate the environment of the article and form no part of the claimed design.

**1 Claim, 6 Drawing Sheets**

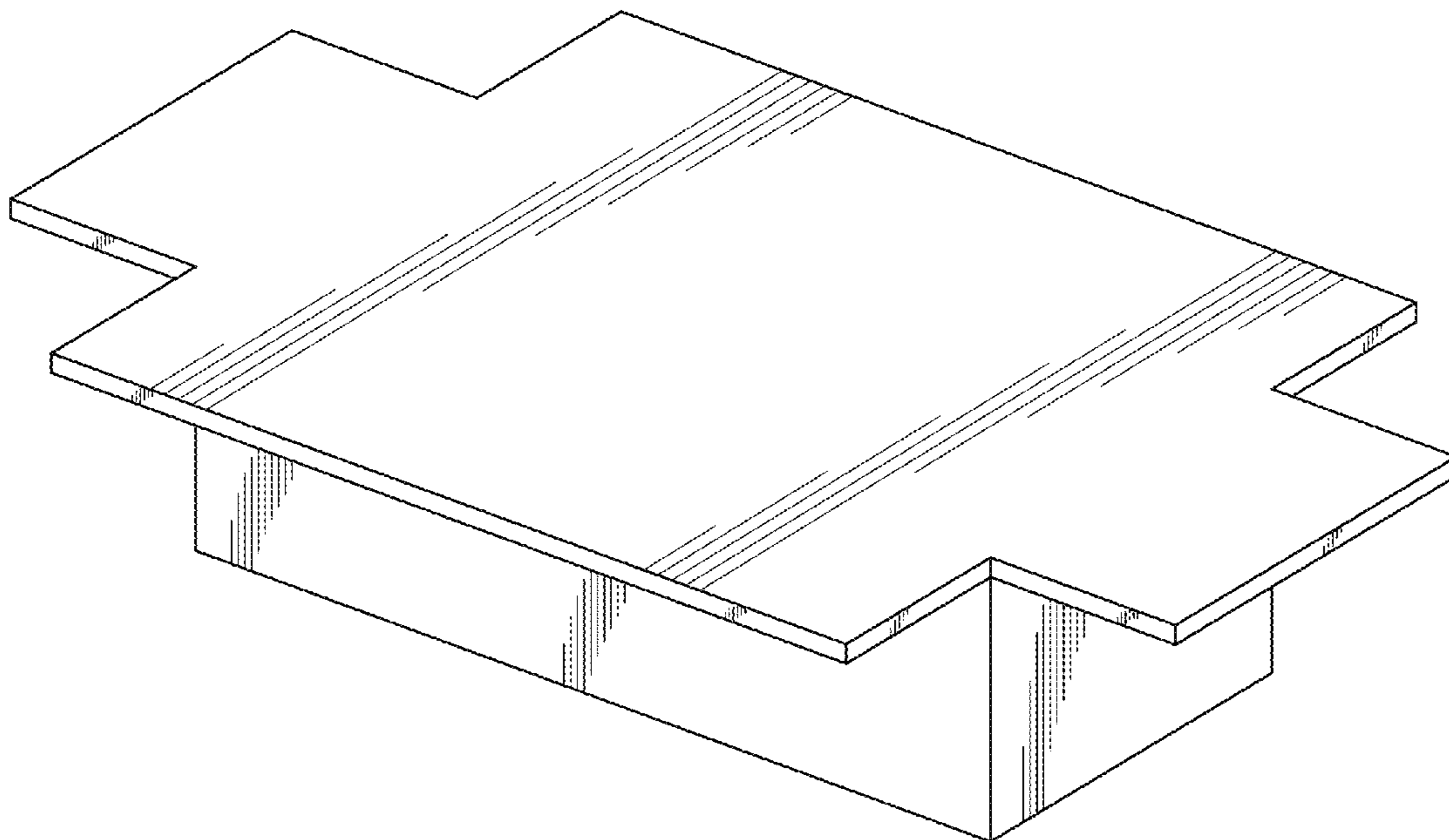

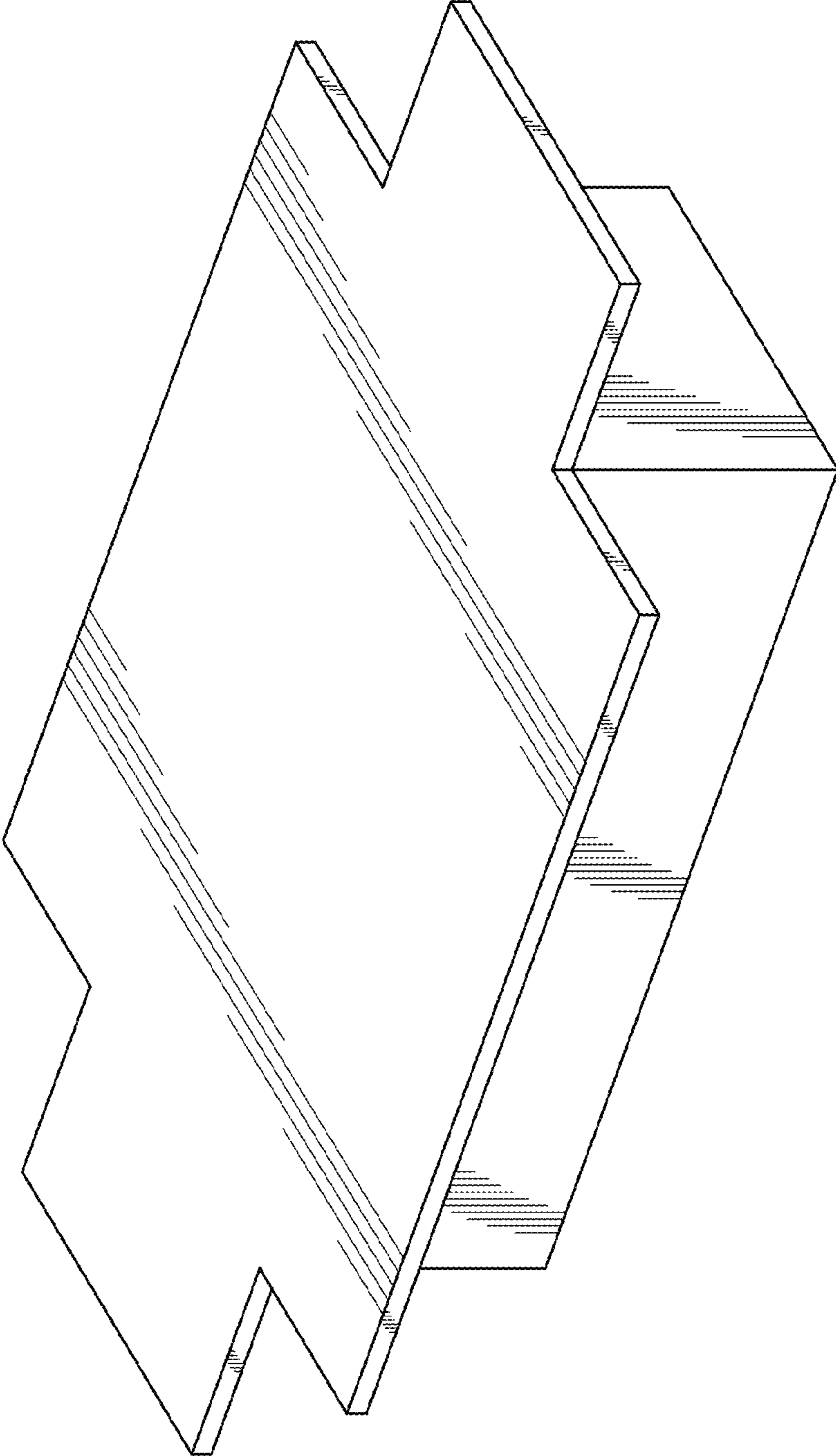

Fig. 1

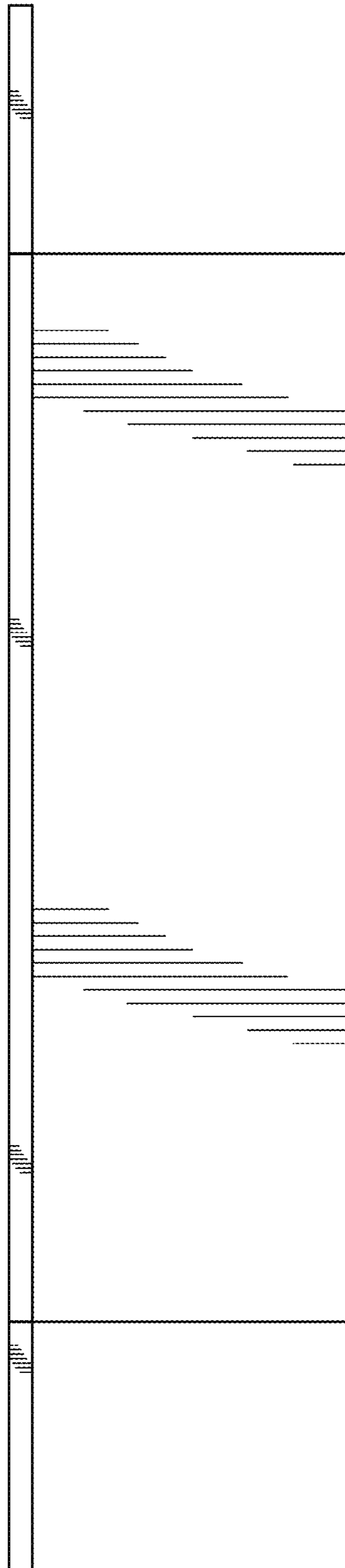

Fig. 2

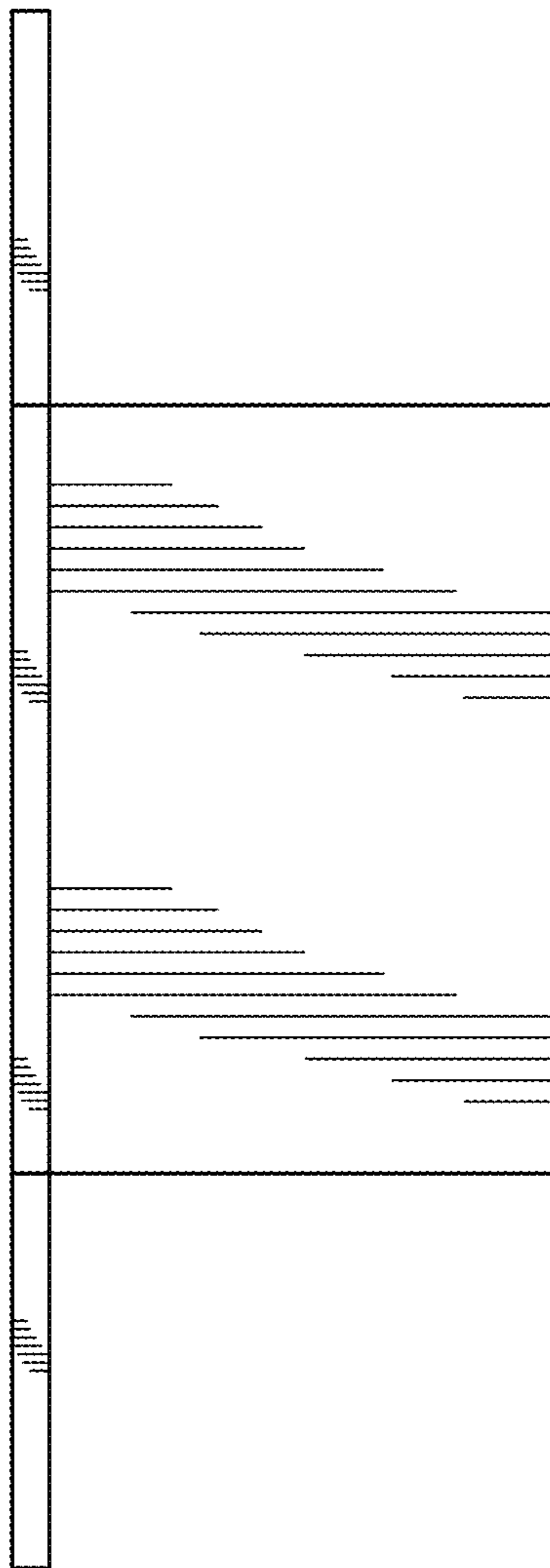

Fig. 3

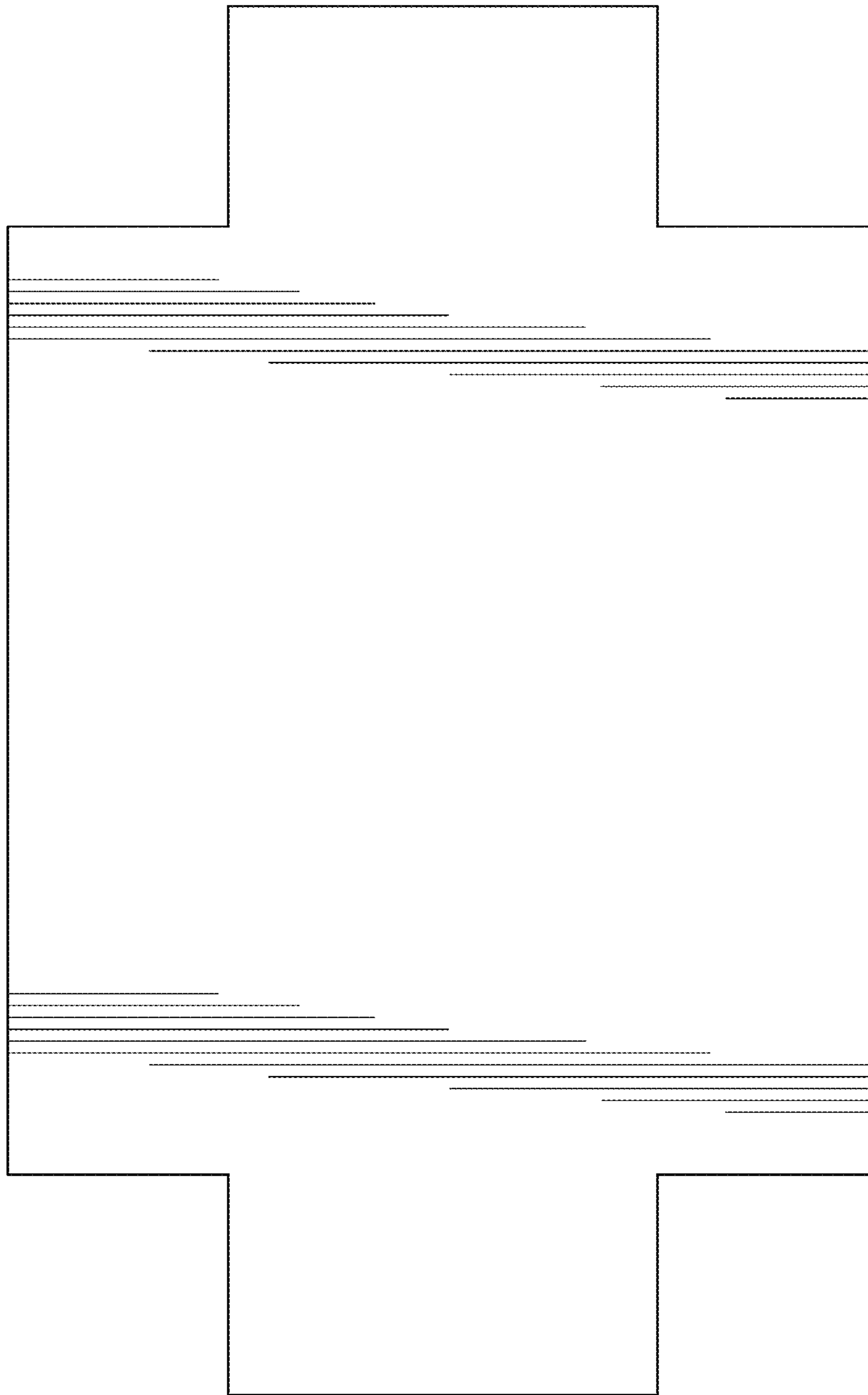

Fig. 4

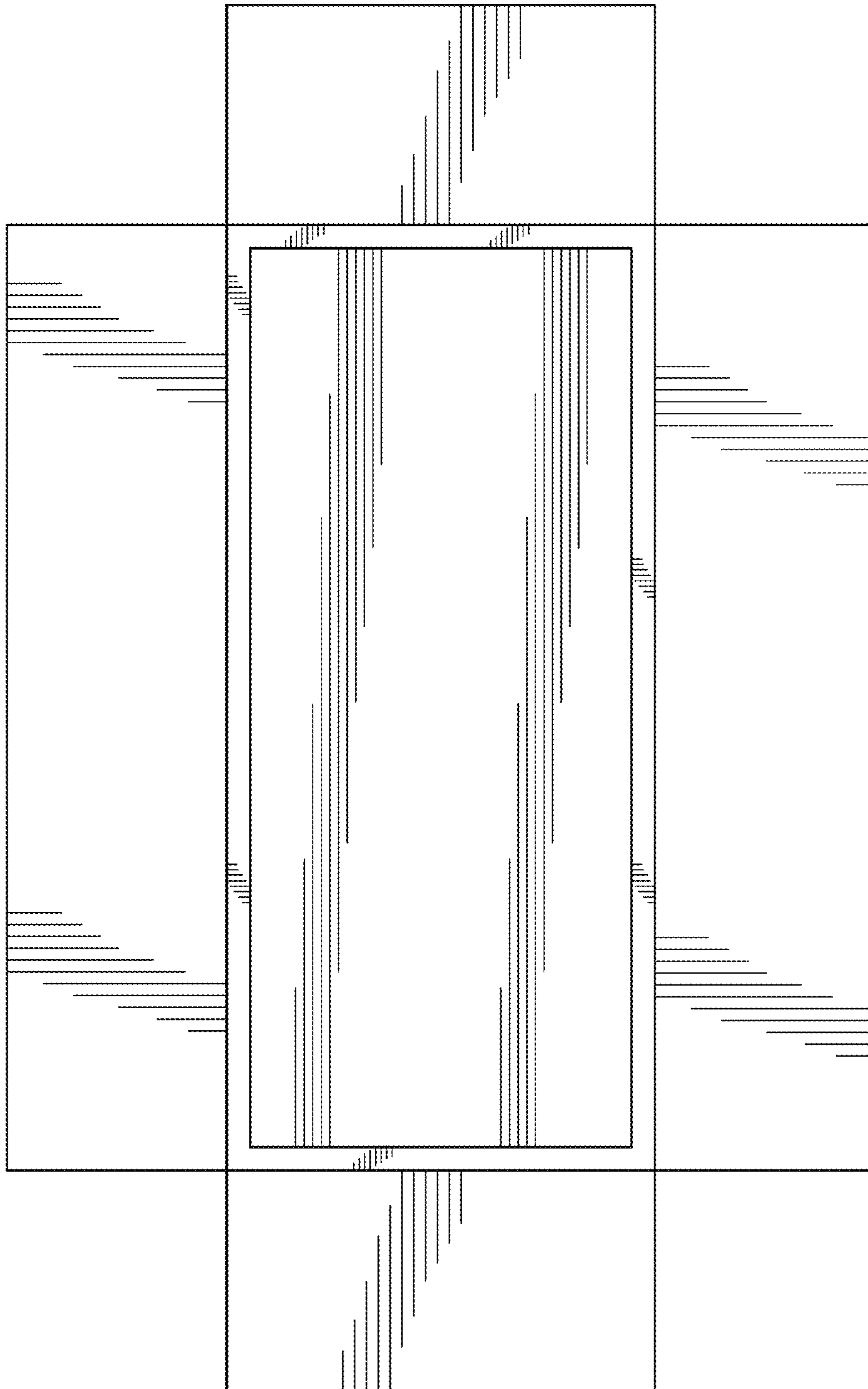

Fig. 5

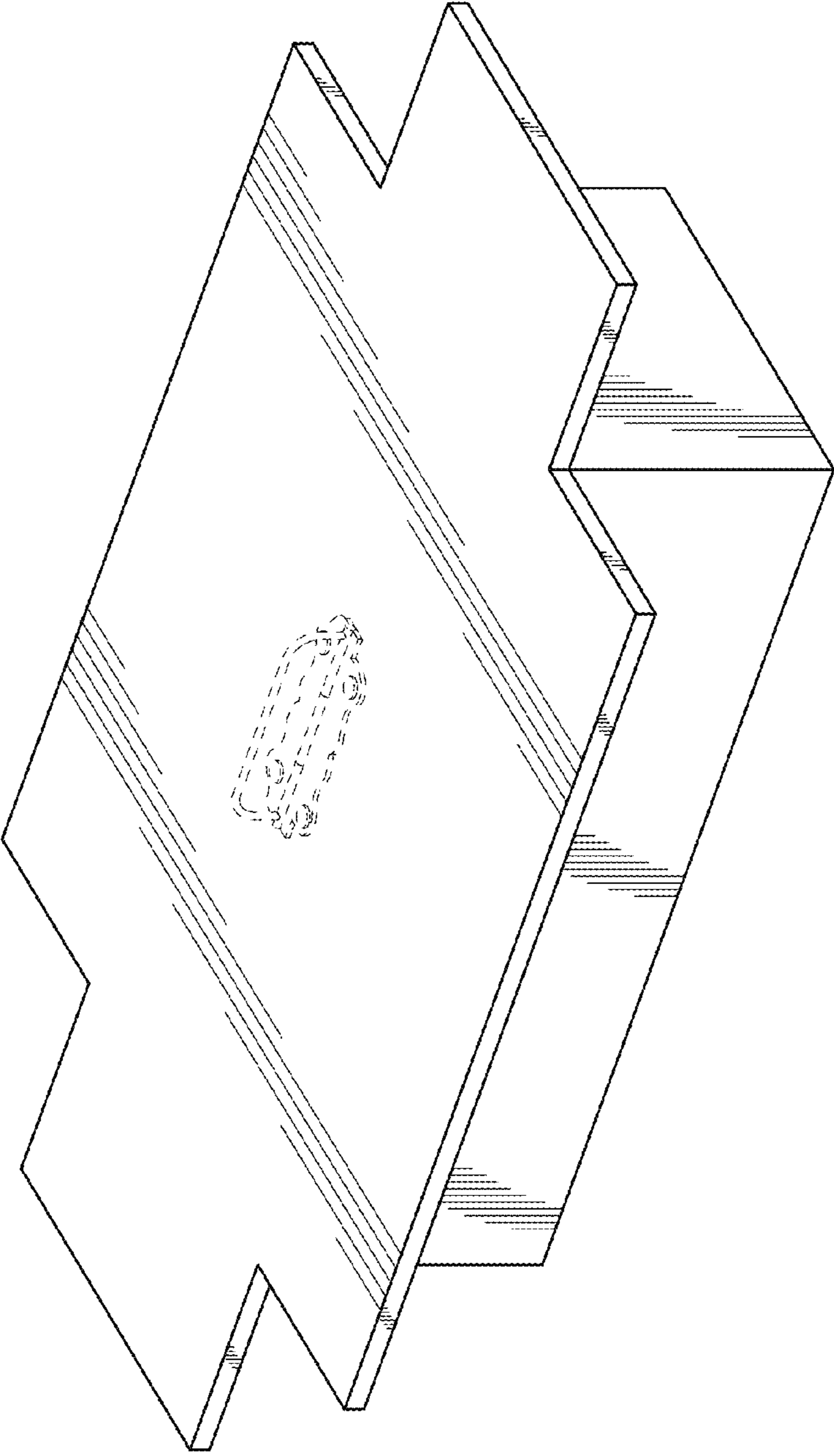

Fig. 6