

US00D721592S

(12) **United States Design Patent**
Peng

(10) **Patent No.:** **US D721,592 S**
(45) **Date of Patent:** **** Jan. 27, 2015**

(54) **DISPENSER CONTAINER**
(71) Applicant: **Pandian Peng**, Shenzhen (CN)
(72) Inventor: **Pandian Peng**, Shenzhen (CN)
(**) Term: **14 Years**
(21) Appl. No.: **29/482,010**
(22) Filed: **Feb. 12, 2014**
(51) **LOC (10) Cl.** **09-01**
(52) **U.S. Cl.**
USPC **D9/602; D9/521; D9/529**
(58) **Field of Classification Search**
USPC D9/500–504, 516, 520–521, 537–559,
D9/563–566, 600, 602–604, 652, 667;
215/381–384; D21/606
See application file for complete search history.

D612,264 S * 3/2010 Miksovsky D6/542
D612,741 S * 3/2010 Miksovsky D6/542
D631,752 S * 2/2011 Kuzma et al. D9/542
D644,525 S * 9/2011 Howell et al. D9/521
D651,518 S * 1/2012 Padain et al. D9/520
D663,790 S * 7/2012 Williams D21/606

* cited by examiner

Primary Examiner — Sandra Morris
(74) *Attorney, Agent, or Firm* — Xiyan Zhang

(57) **CLAIM**
The ornamental design for a dispenser container, as shown and described.

DESCRIPTION

FIG. 1 is a perspective view of one embodiment of the dispenser container showing my new design;
FIG. 2 is a front plan view thereof;
FIG. 3 is a back plan view thereof;
FIG. 4 is a left plan view thereof;
FIG. 5 is a right plan view thereof;
FIG. 6 is a top plan view thereof;
FIG. 7 is a bottom plan view thereof;
FIG. 8 is a cross-sectional view taken along line 8-8 thereof;
and,
FIG. 9 is a cross-sectional view taken along line 9-9 thereof.

(56) **References Cited**
U.S. PATENT DOCUMENTS
D238,906 S * 2/1976 Cone D9/602
D326,297 S * 5/1992 Noshiro D21/606
D424,944 S * 5/2000 Mohary et al. D9/520
D438,801 S * 3/2001 Mohary et al. D9/520
D446,724 S * 8/2001 Fenton et al. D9/521
D609,098 S * 2/2010 Almstead et al. D9/521
D612,263 S * 3/2010 Miksovsky D6/542

1 Claim, 8 Drawing Sheets

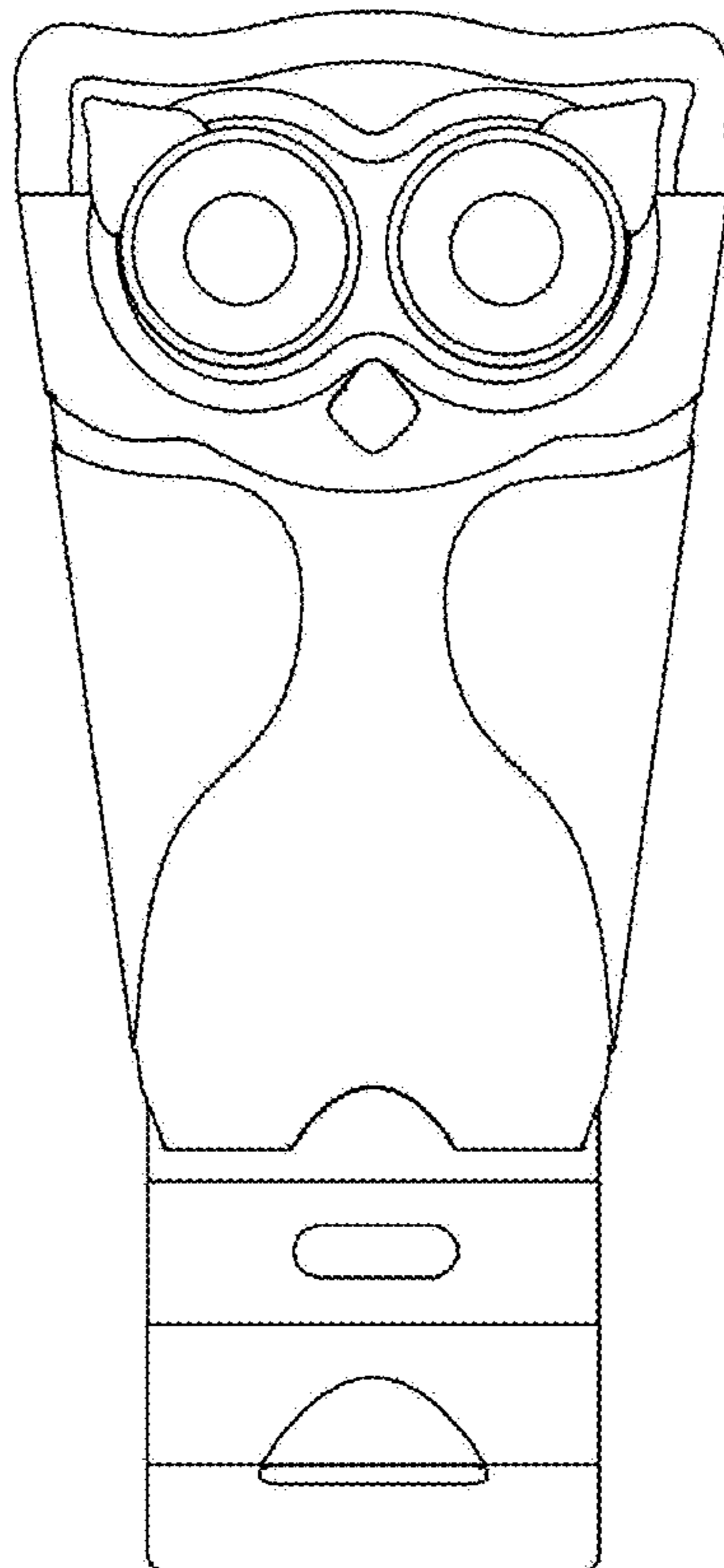

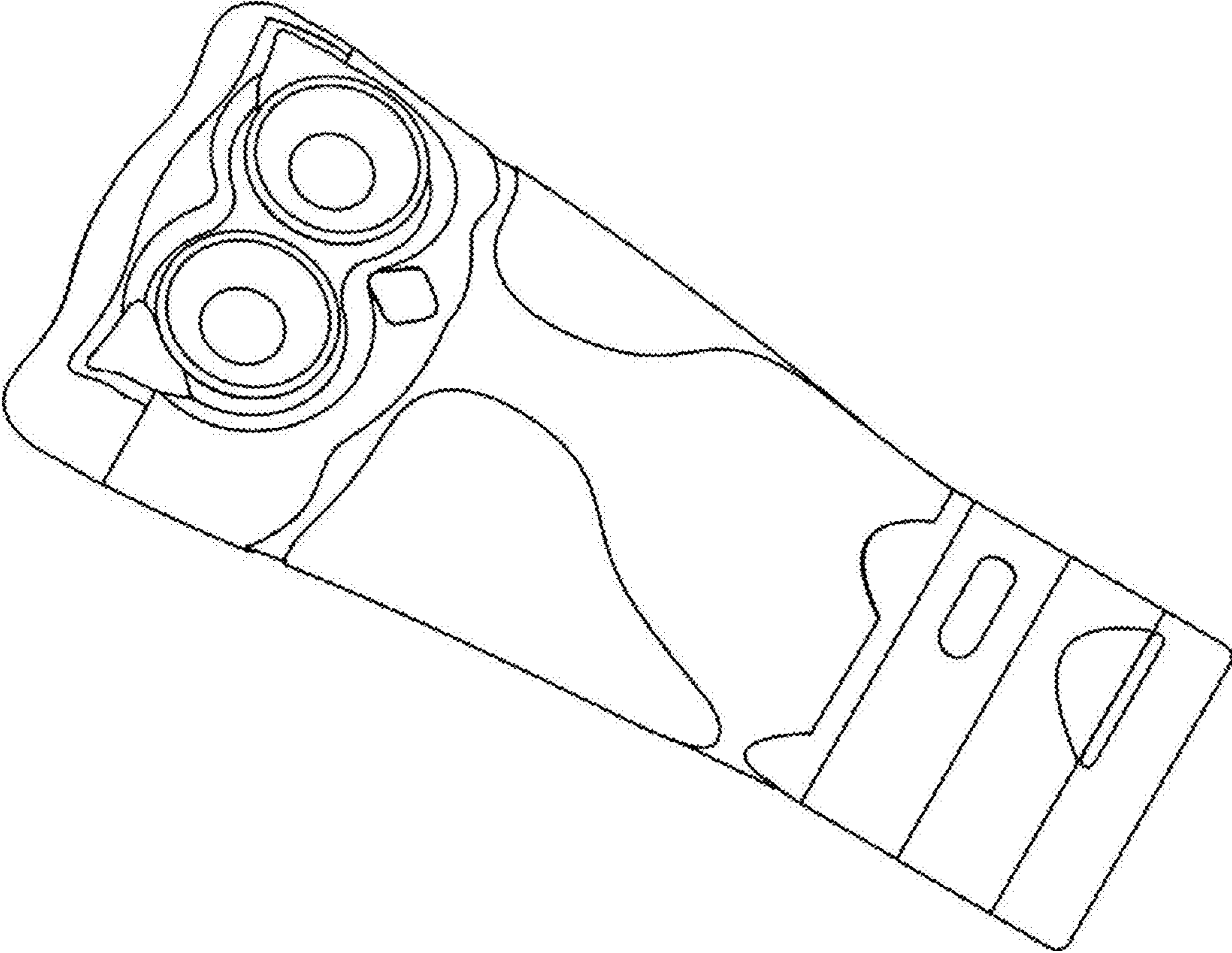

Fig. 1

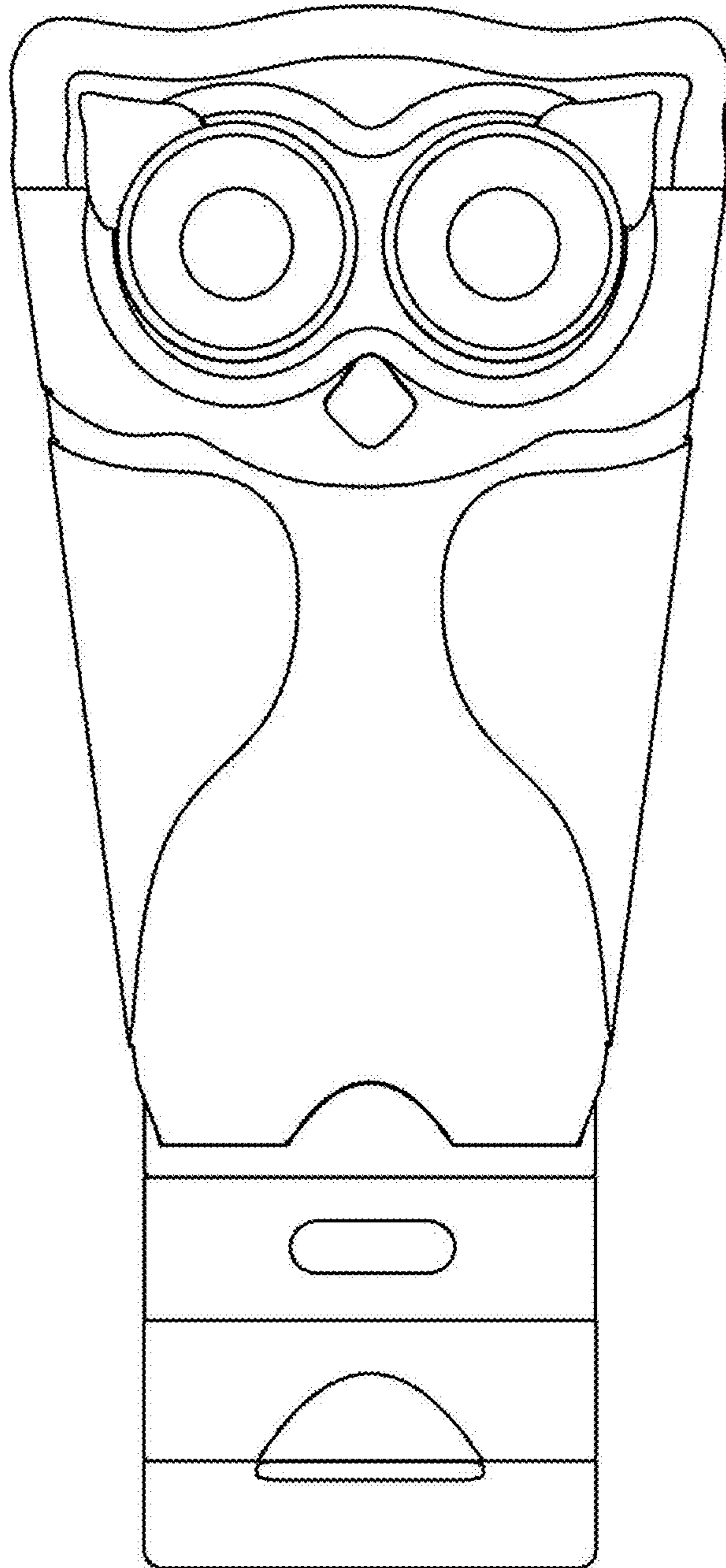

Fig. 2

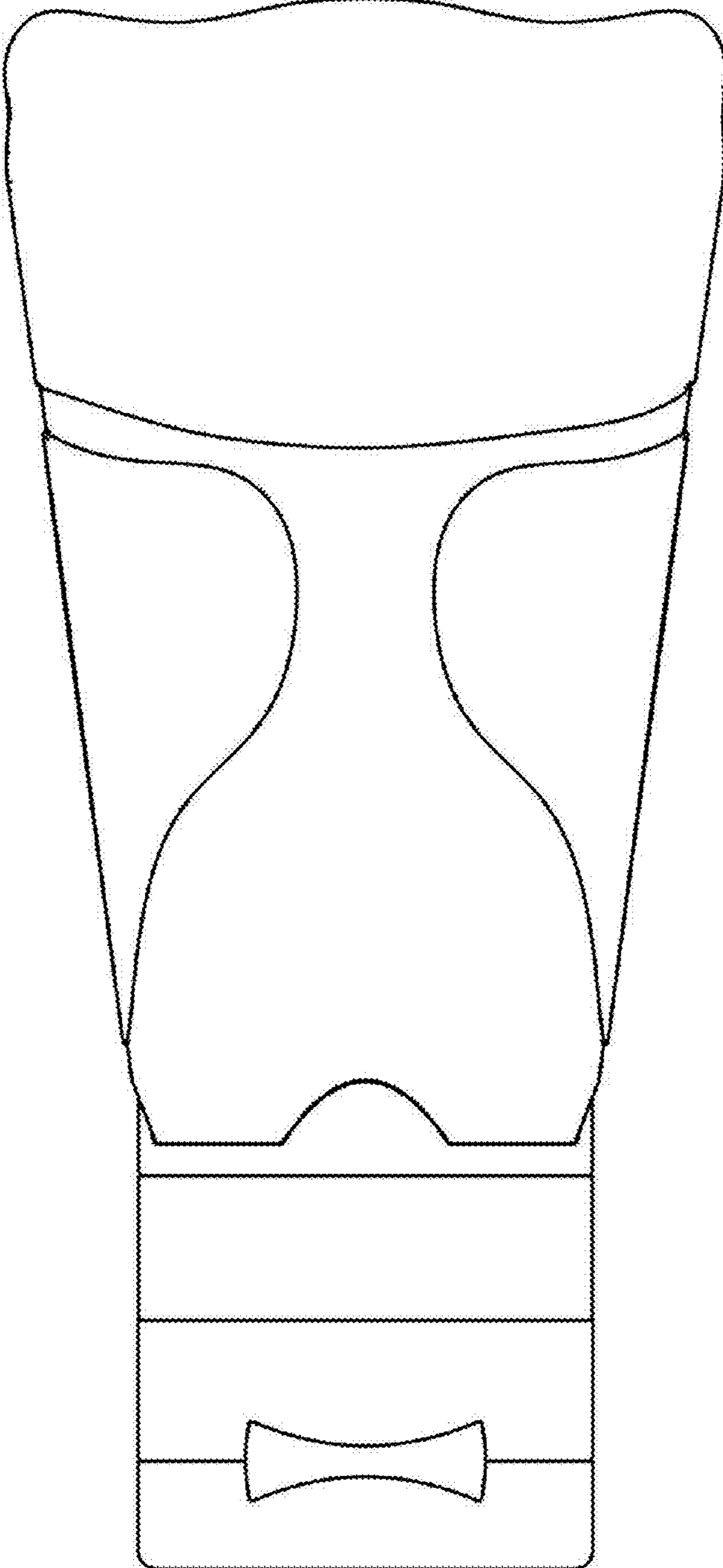

Fig. 3

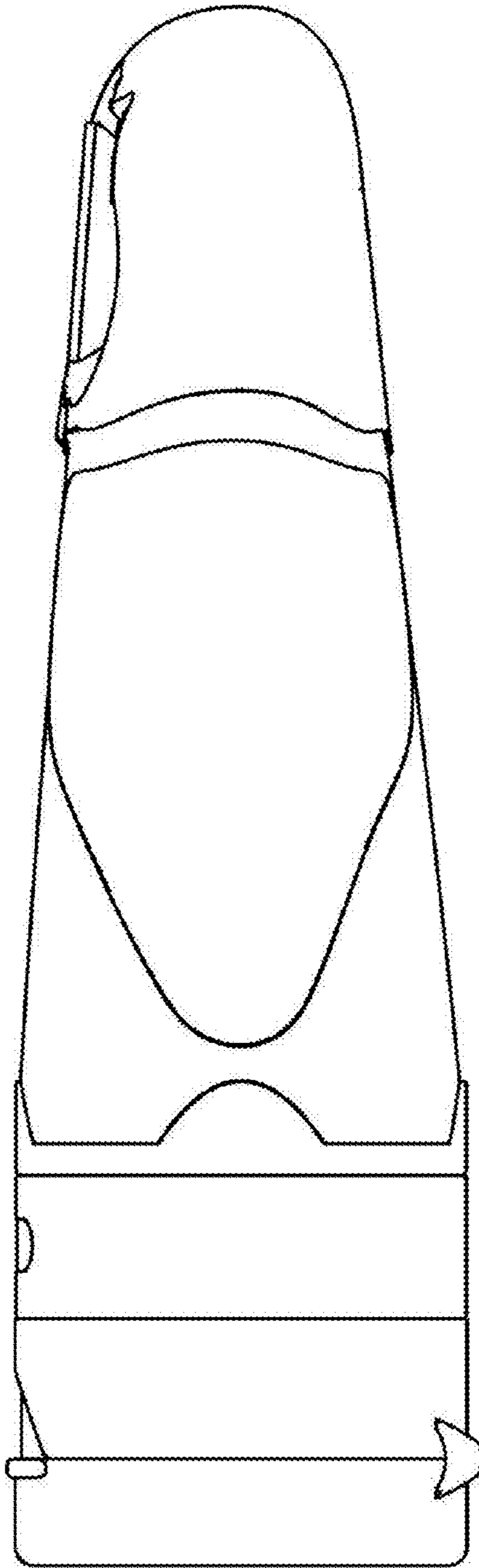

Fig. 4

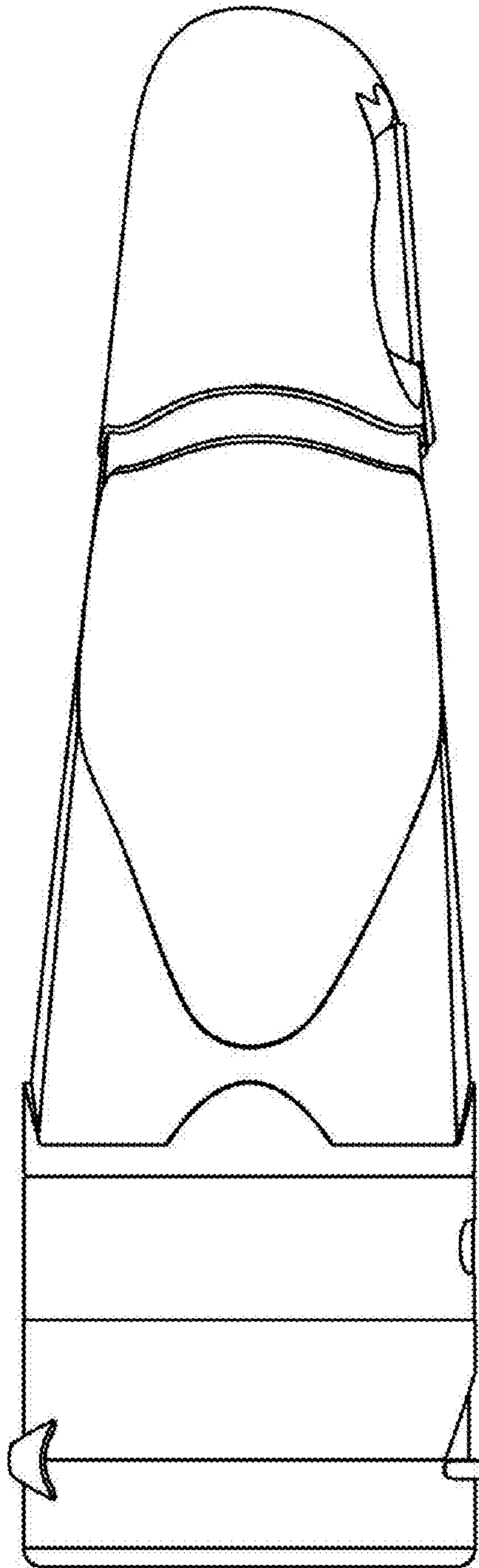

Fig. 5

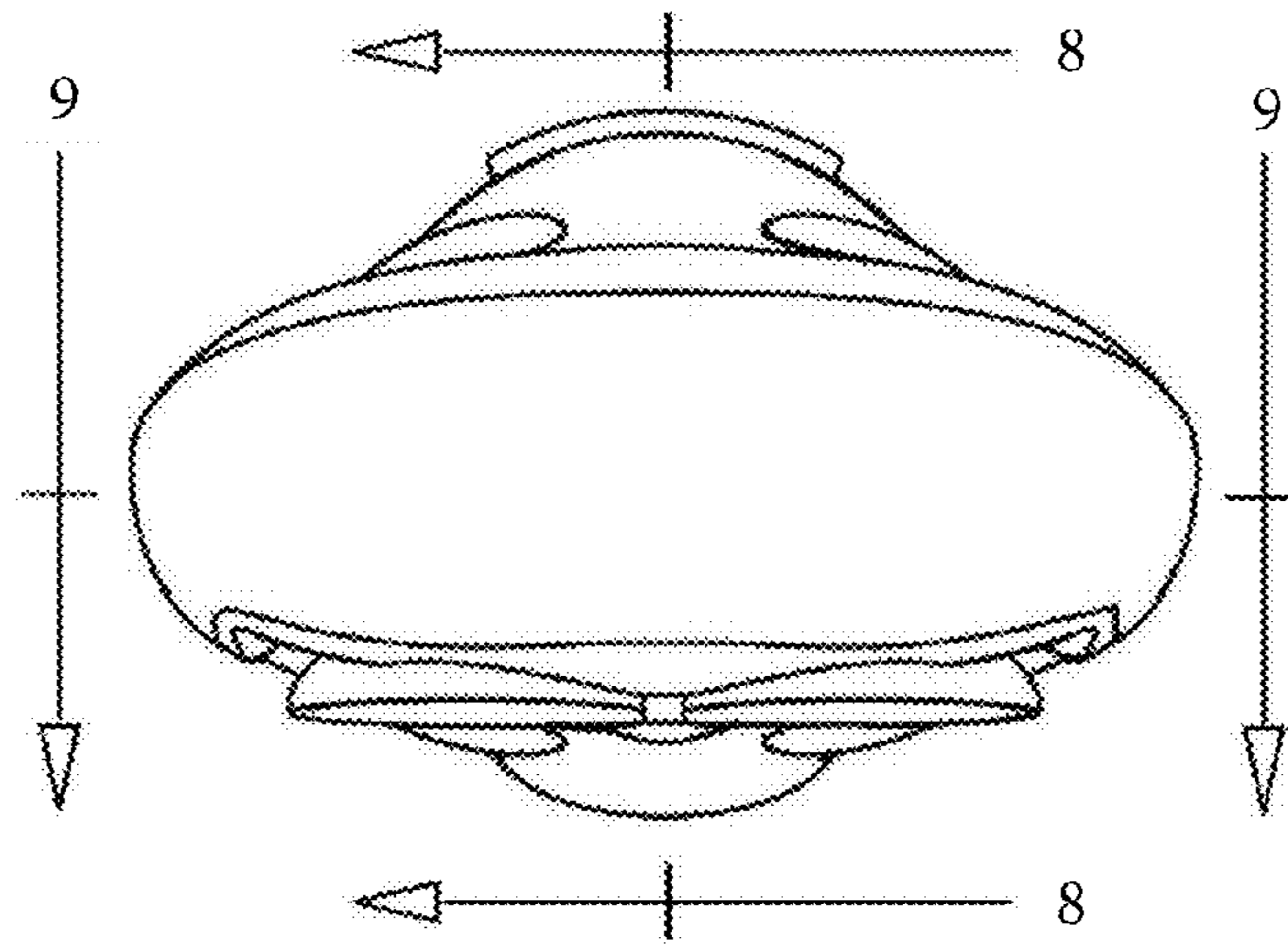

Fig. 6

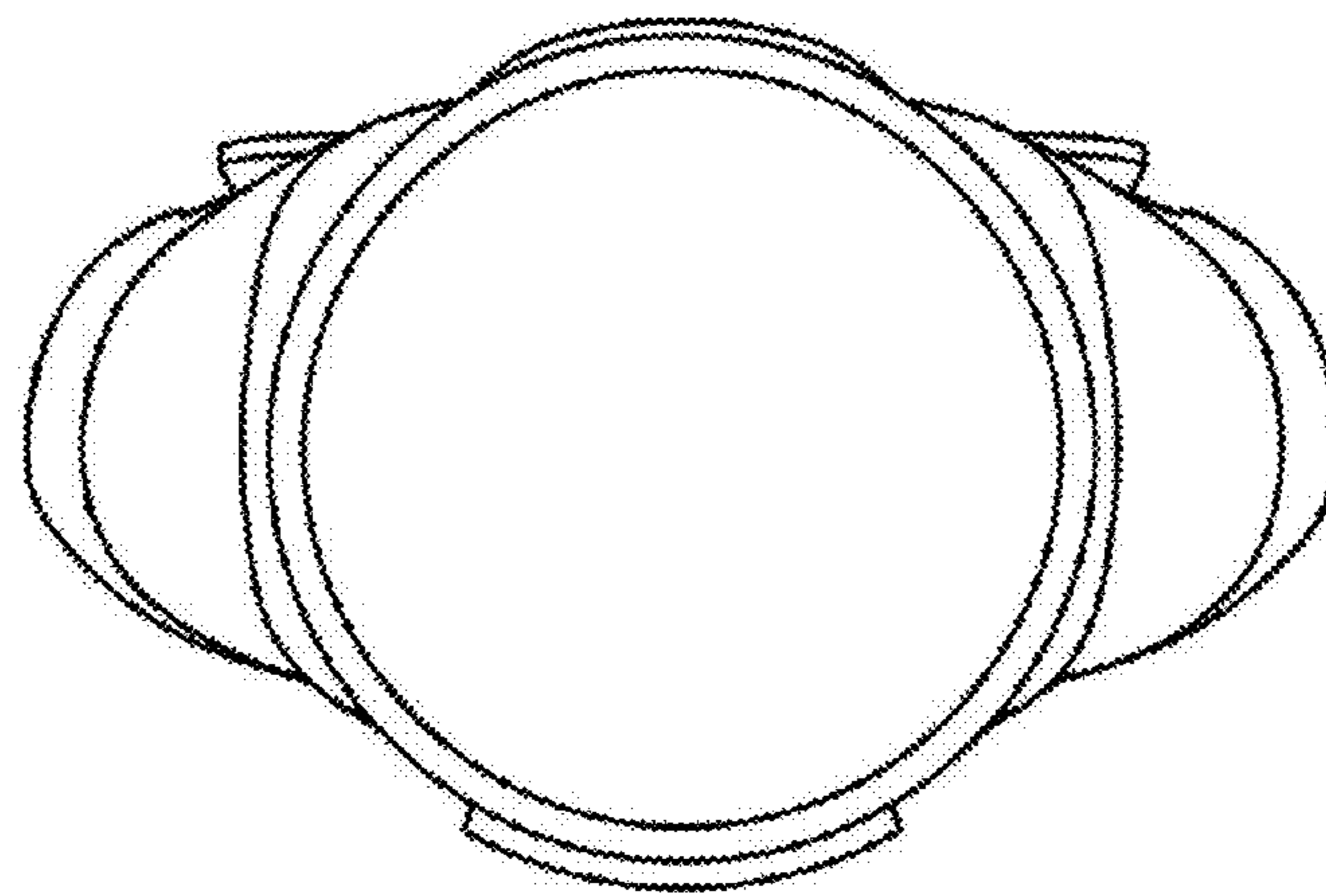

Fig. 7

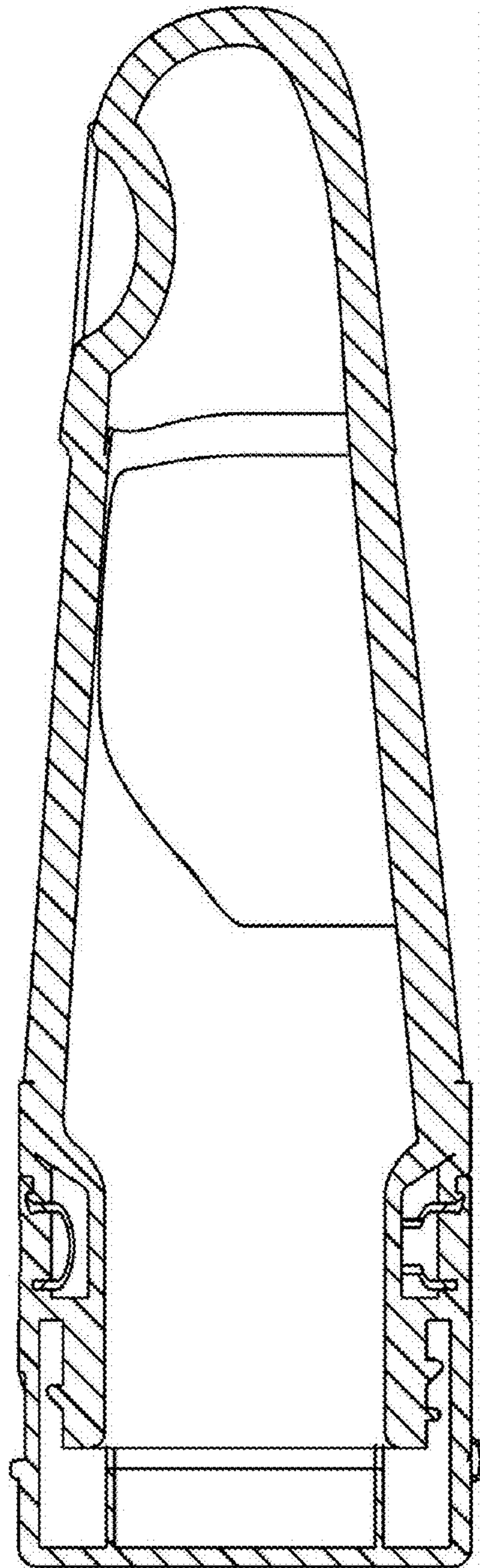

Fig. 8

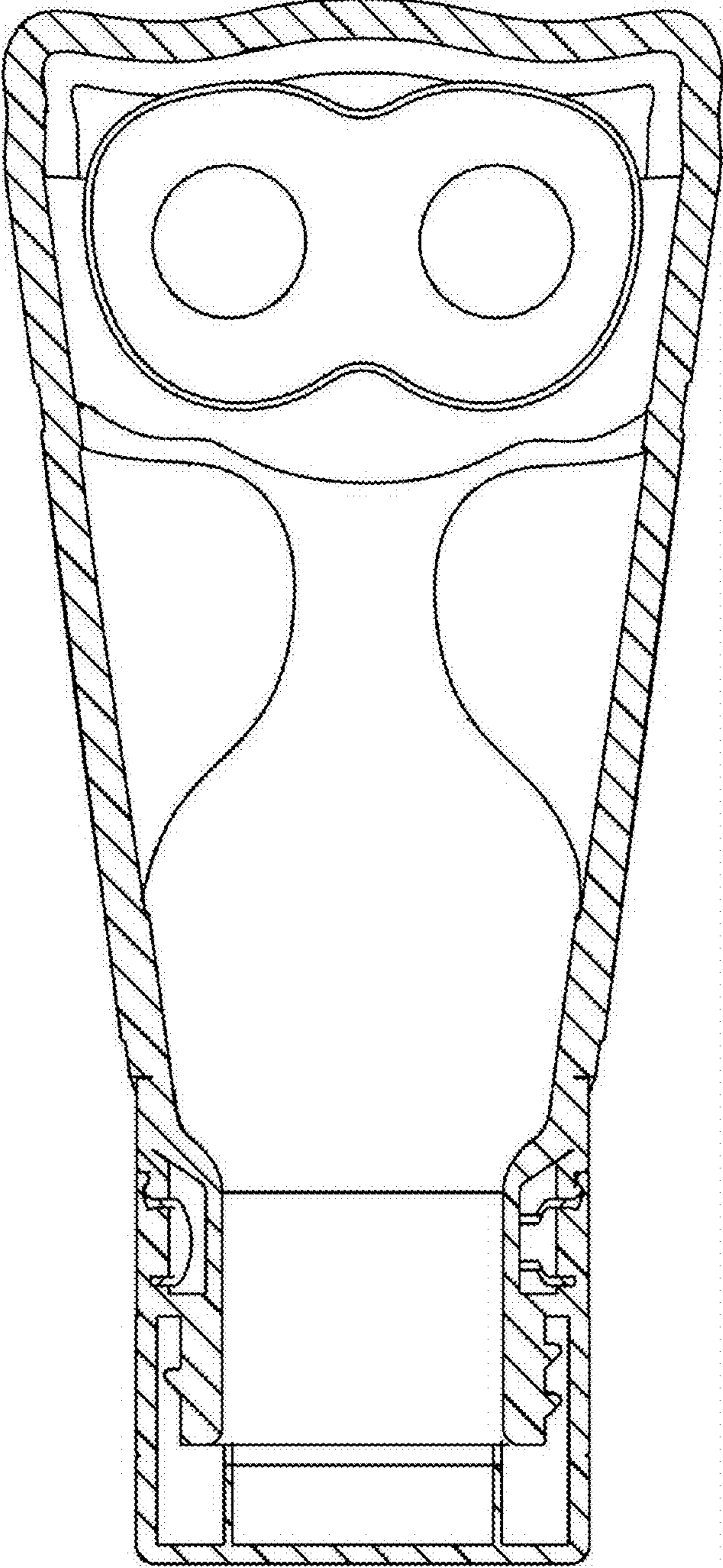

Fig. 9