



US00D721590S

(12) **United States Design Patent**
Hughes et al.

(10) **Patent No.:** **US D721,590 S**
(45) **Date of Patent:** **** Jan. 27, 2015**

(54) **BOTTLE**

(71) Applicant: **Euro-Pro Operating LLC**, Newton, MA (US)

(72) Inventors: **William Scott Hughes**, Waltham, MA (US); **Robert H. Bruno**, Avon, CT (US); **Jefferson L. Deuchler**, West Hartford, CT (US); **Matthew L. Phillips**, Litchfield, CT (US)

(73) Assignee: **Euro-Pro Operating LLC**, Newton, MA (US)

(**) Term: **14 Years**

(21) Appl. No.: **29/447,291**

(22) Filed: **Mar. 1, 2013**

(51) **LOC (10) Cl.** **09-01**

(52) **U.S. Cl.**
USPC **D9/516; D9/563**

(58) **Field of Classification Search**
CPC B65D 1/00; B65D 1/02; B65D 1/0223; B65D 23/00; B65D 2501/00; B65D 2501/0009
USPC D9/516, 530, 540, 542-543, 563, 571, D9/574-575, 682, 685; 215/379, 381-382; 220/660, 669, 675
See application file for complete search history.

(56) **References Cited**

U.S. PATENT DOCUMENTS

D116,915 S *	10/1939	Jensen	D9/543
D205,731 S *	9/1966	Levy	D9/542
D220,167 S *	3/1971	Barker	D9/542
D222,530 S *	11/1971	Luedtke	D9/529
D225,155 S *	11/1972	Schafer	D9/542
D226,551 S *	3/1973	Weckman	D9/542
D238,555 S *	1/1976	Blank	D9/550
D469,022 S *	1/2003	Kuzma et al.	D9/550

D489,994 S *	5/2004	Crawford	D9/542
D491,815 S *	6/2004	Crawford	D9/542
D659,000 S *	5/2012	Kim et al.	D9/516
D664,434 S *	7/2012	Kim et al.	D9/516
D693,689 S *	11/2013	Kim et al.	D9/516

* cited by examiner

Primary Examiner — Ian Simmons

Assistant Examiner — Dana L Meyrow

(74) *Attorney, Agent, or Firm* — Wolf, Greenfield & Sacks, P.C.

(57) **CLAIM**

The ornamental design for a bottle, as shown and described.

DESCRIPTION

FIG. 1 is a top, front, left side perspective view of a bottle showing a first embodiment of our new design;
 FIG. 2 is a front elevational view thereof;
 FIG. 3 is a rear elevational view thereof;
 FIG. 4 is a left side elevational view thereof;
 FIG. 5 is a right side elevational view thereof;
 FIG. 6 is a top plan view thereof;
 FIG. 7 is a bottom plan view thereof;
 FIG. 8 is a top, front, left side perspective view of a second embodiment thereof;
 FIG. 9 is a front elevational view of FIG. 8;
 FIG. 10 is a rear elevational view of FIG. 8;
 FIG. 11 is a left side elevational view of FIG. 8;
 FIG. 12 is a right side elevational view of FIG. 8;
 FIG. 13 is a top plan view of FIG. 8; and,
 FIG. 14 is a bottom plan view of FIG. 8.
 The dashed broken lines in FIGS. 1-14 illustrate the portions of the bottle that form no part of the claimed design. The dot-dash broken lines shown in the figures define the bounds of the claim and form no part thereof.

1 Claim, 12 Drawing Sheets

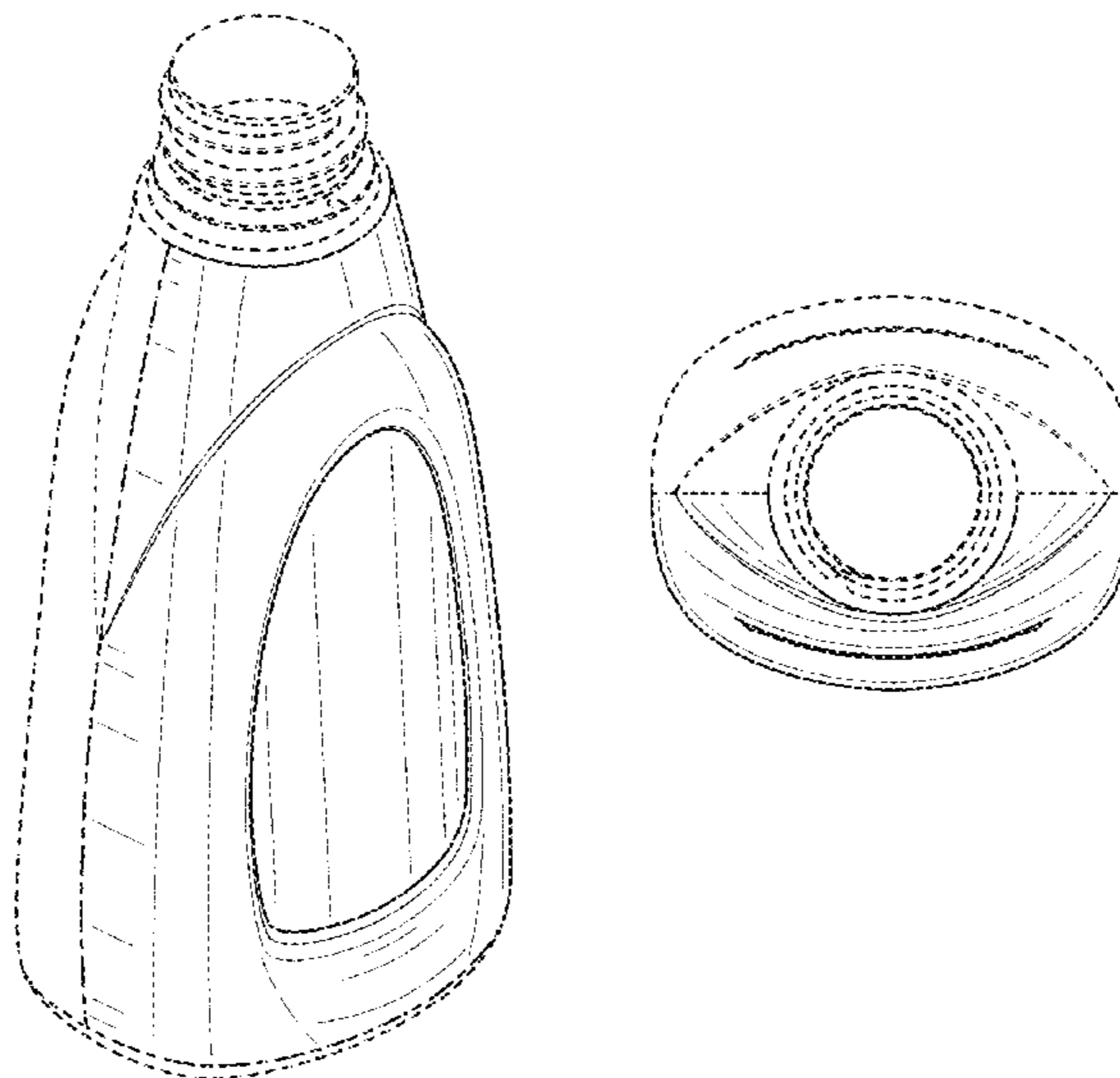

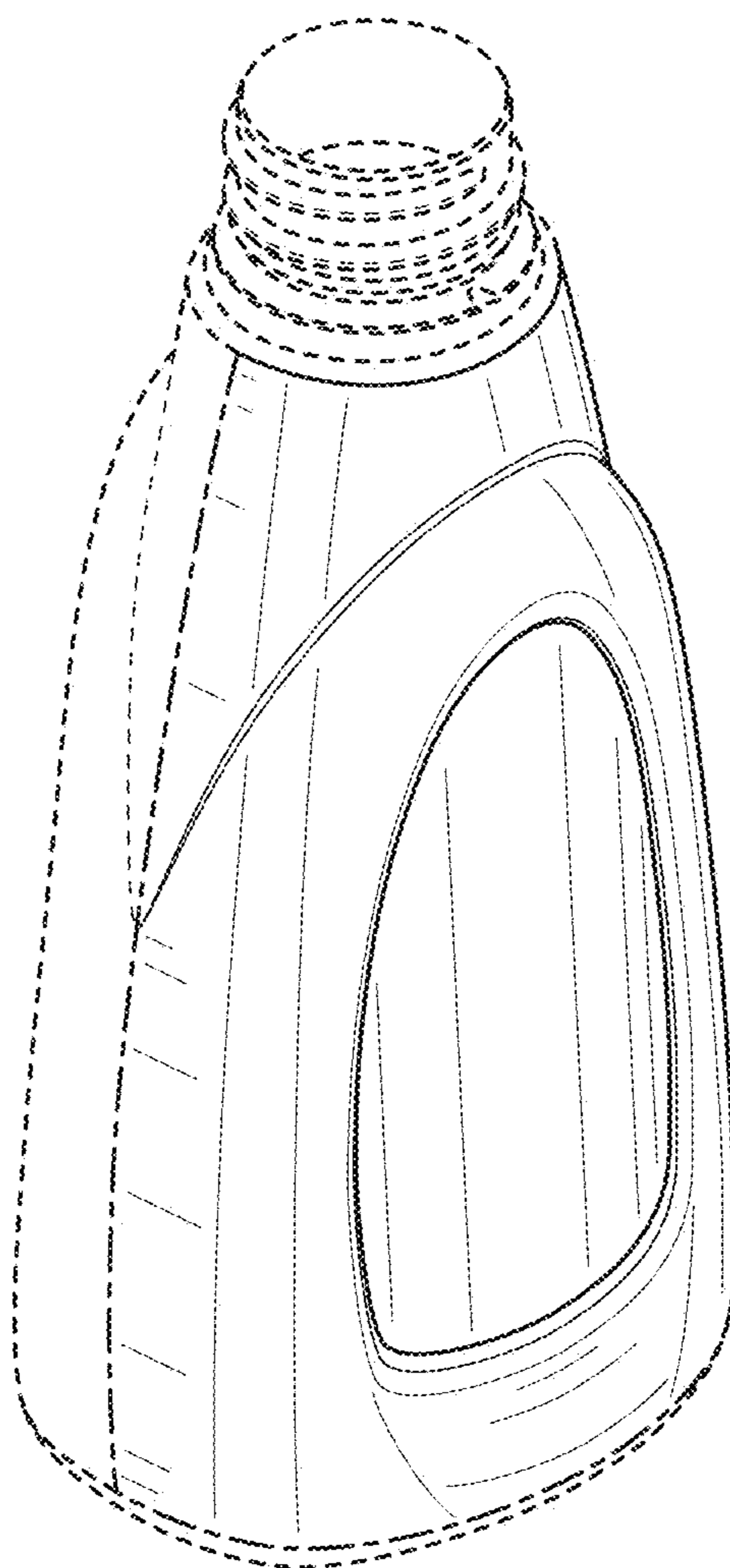

FIG. 1

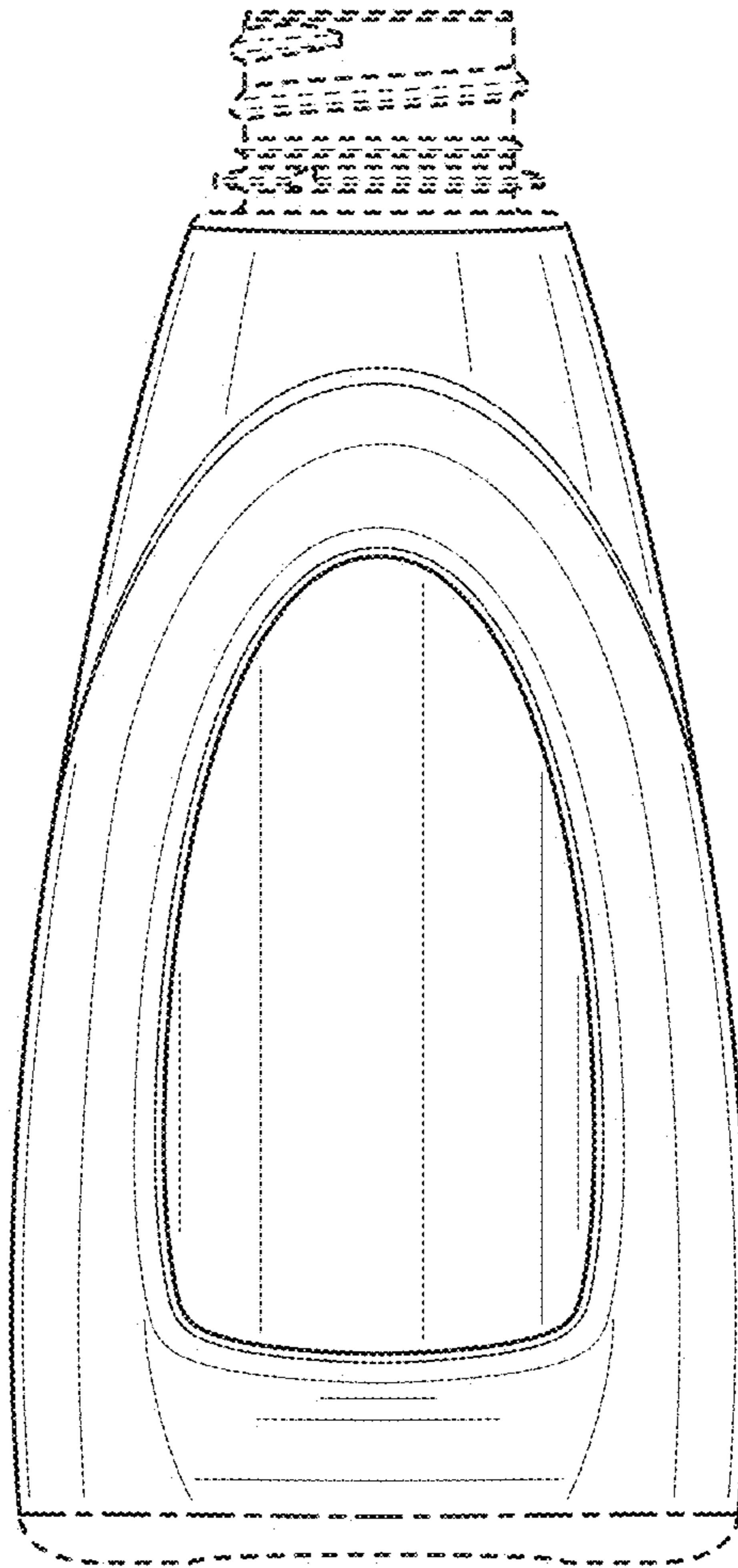

FIG. 2

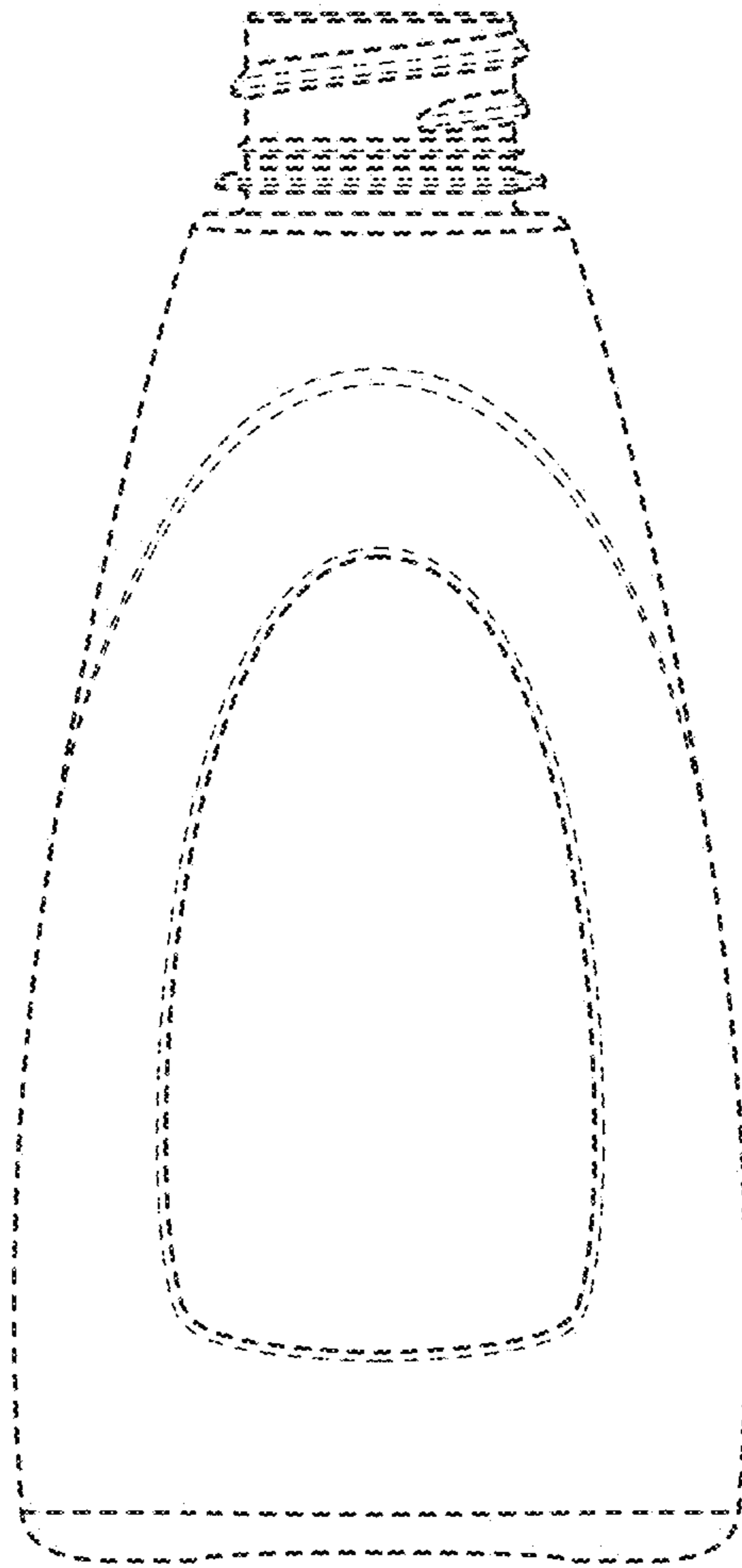

FIG. 3

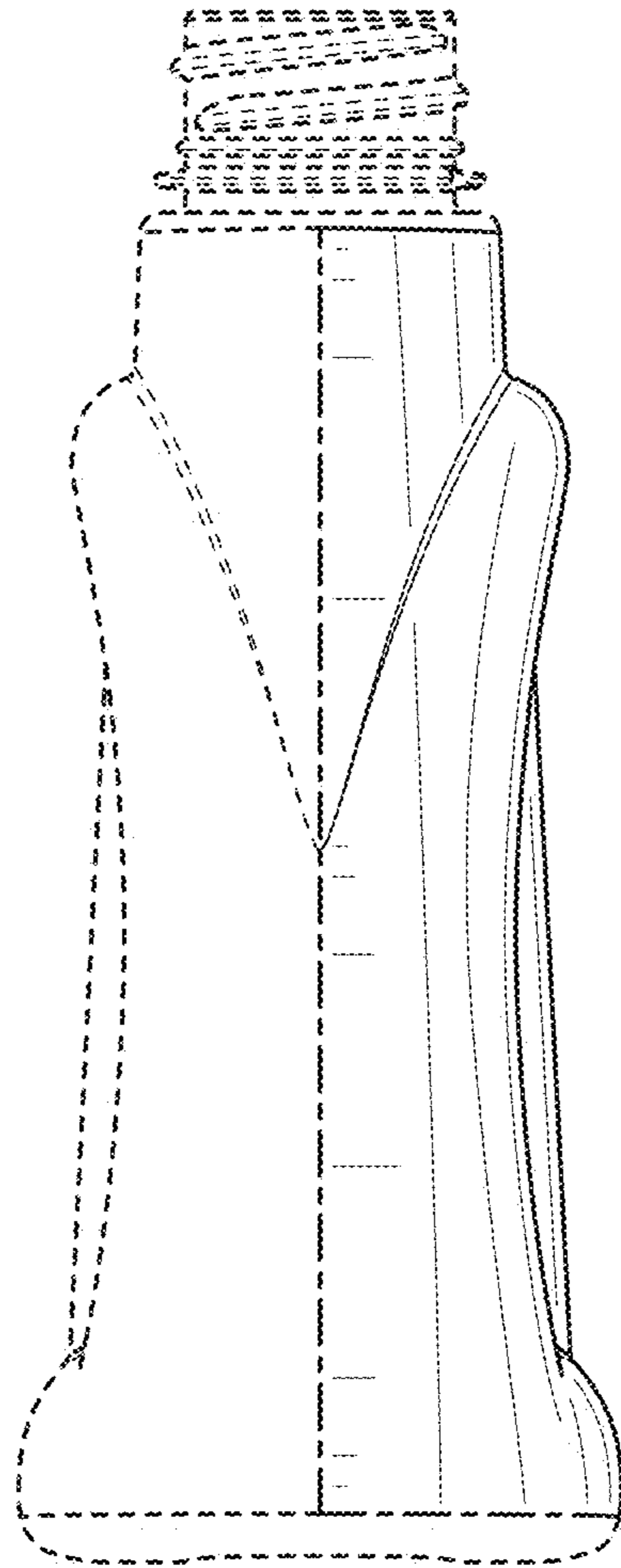

FIG. 4

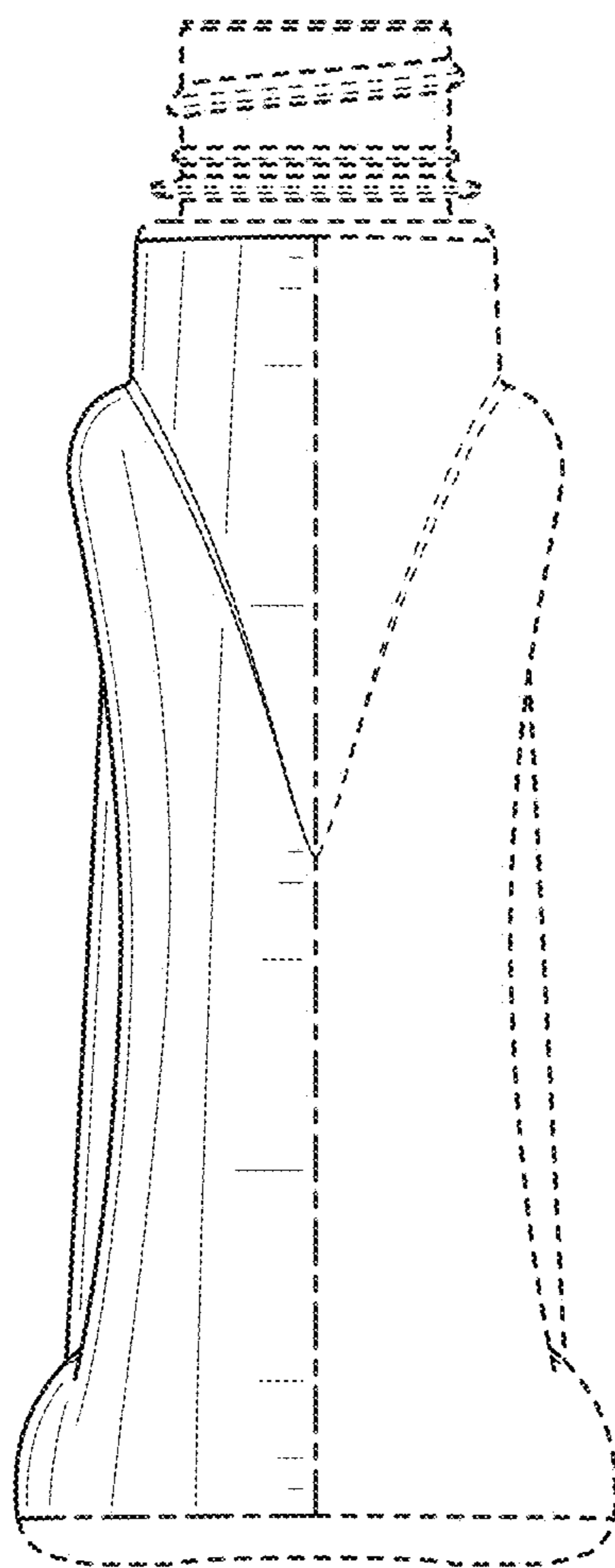

FIG. 5

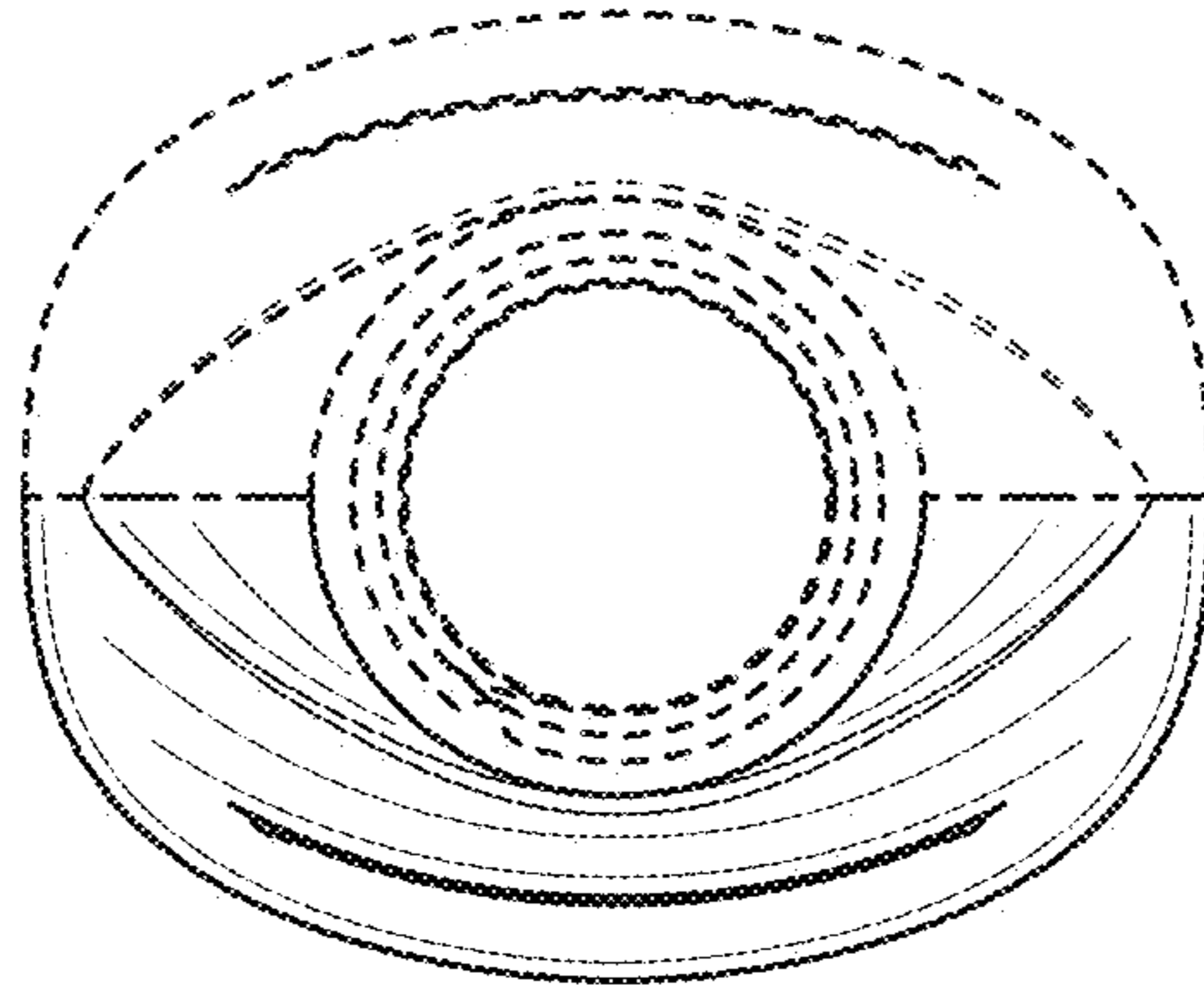

FIG. 6

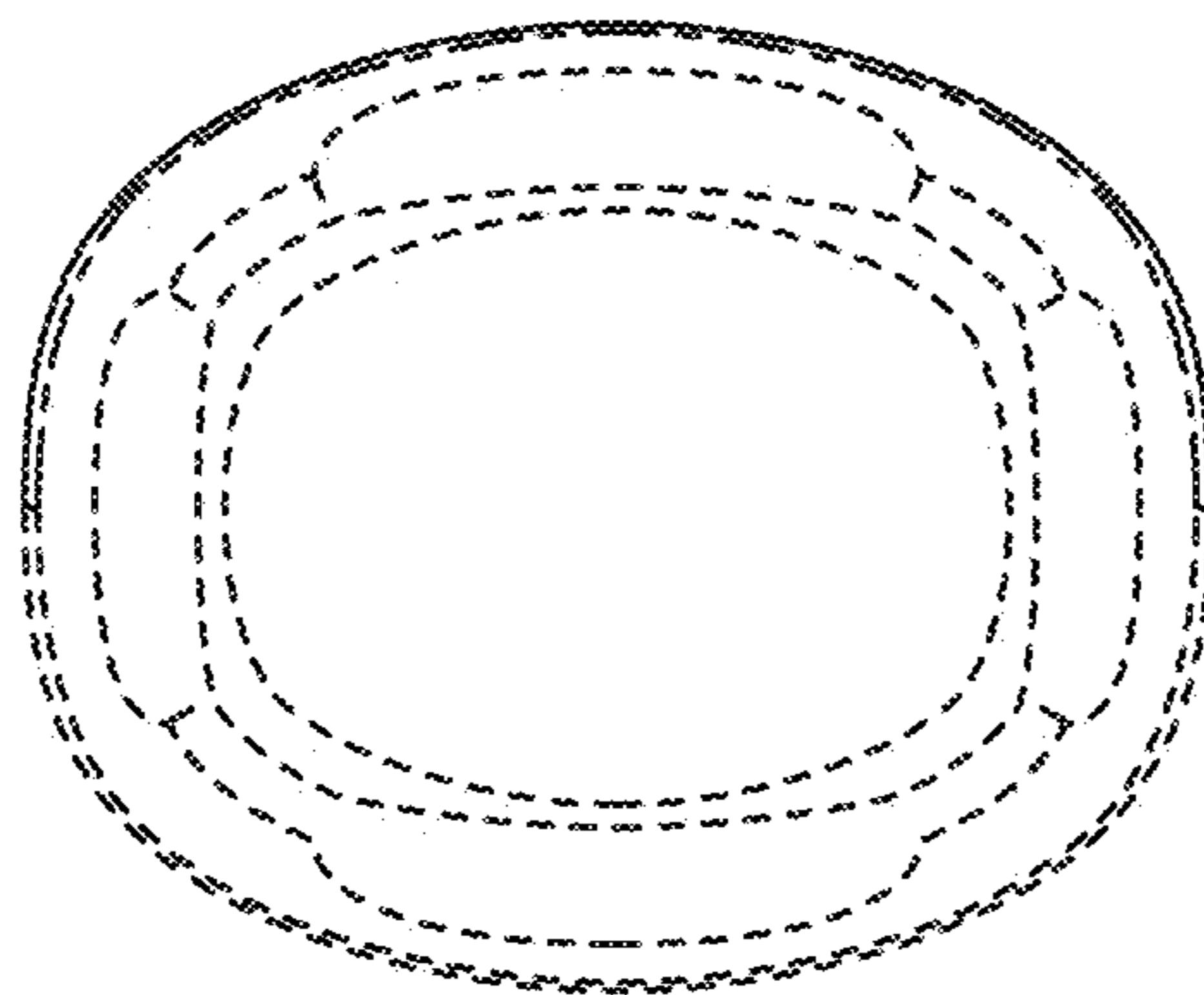

FIG. 7

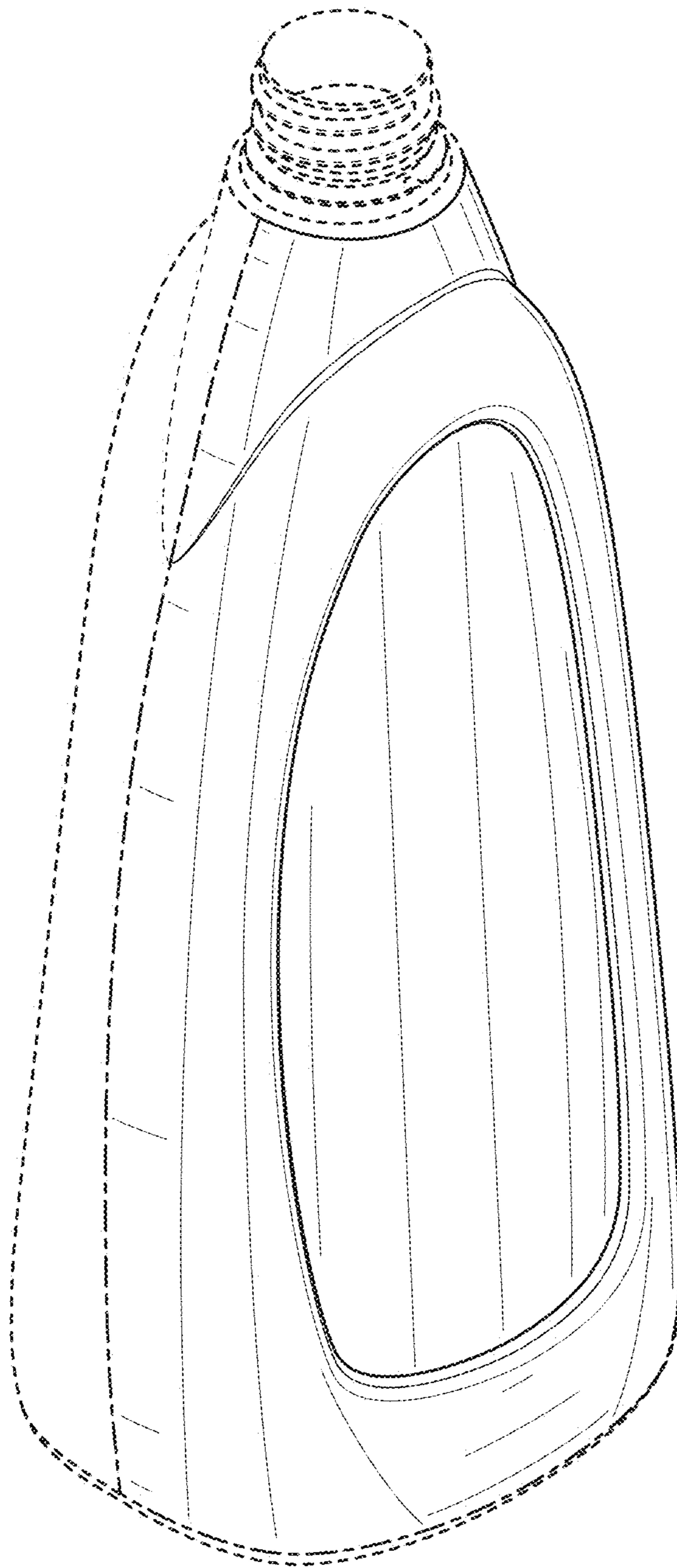

FIG. 8

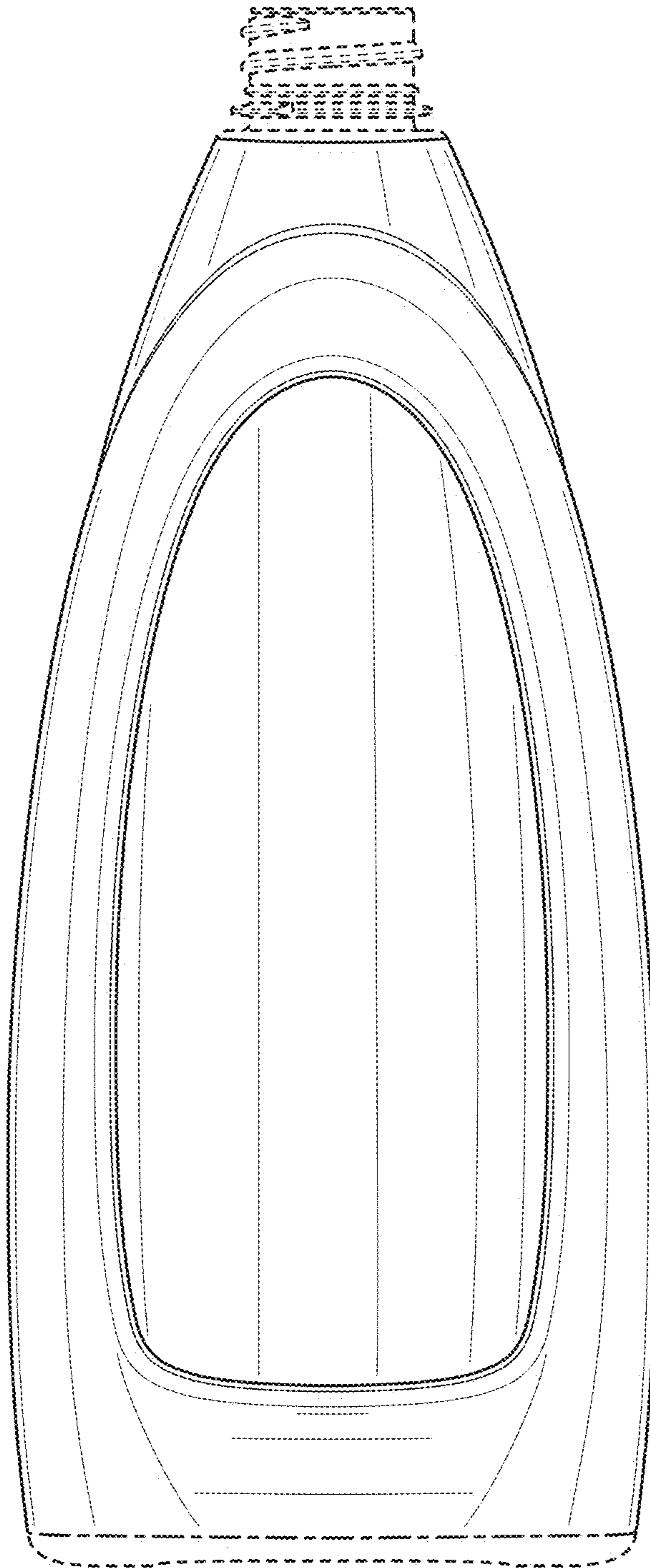

FIG. 9

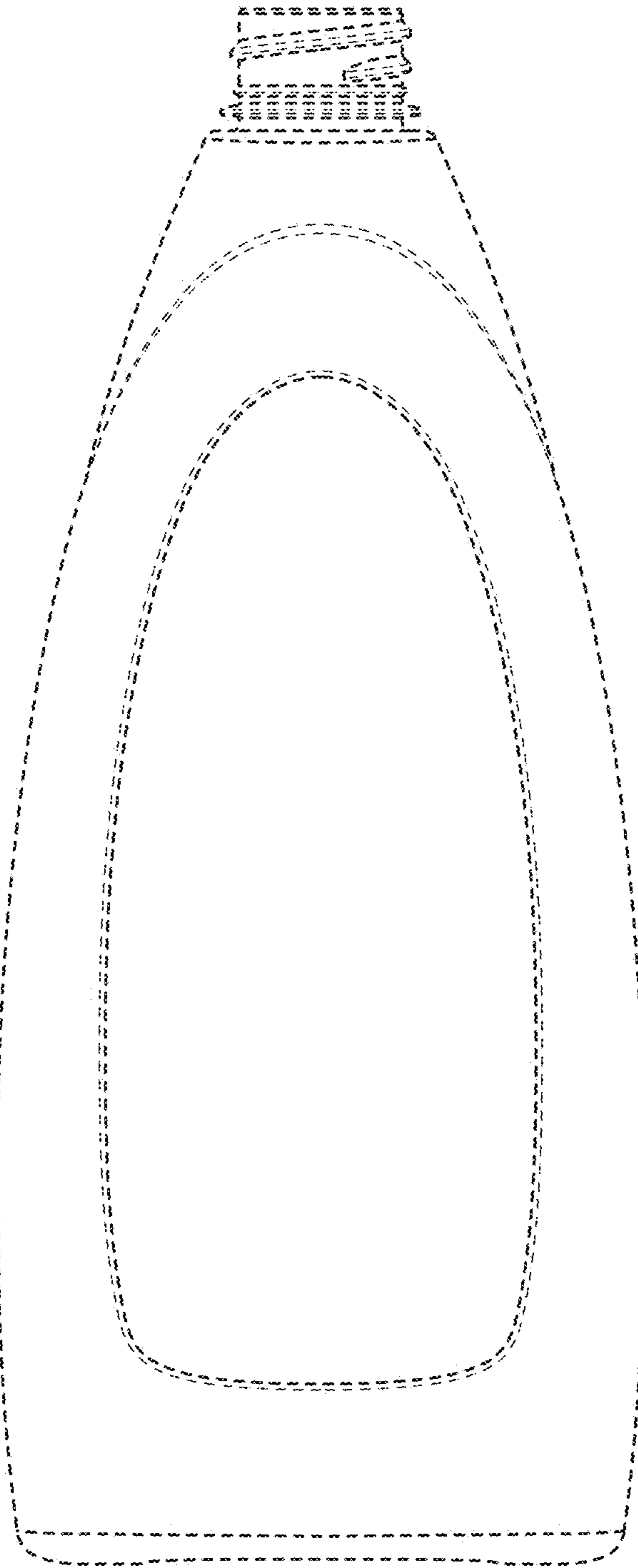

FIG. 10

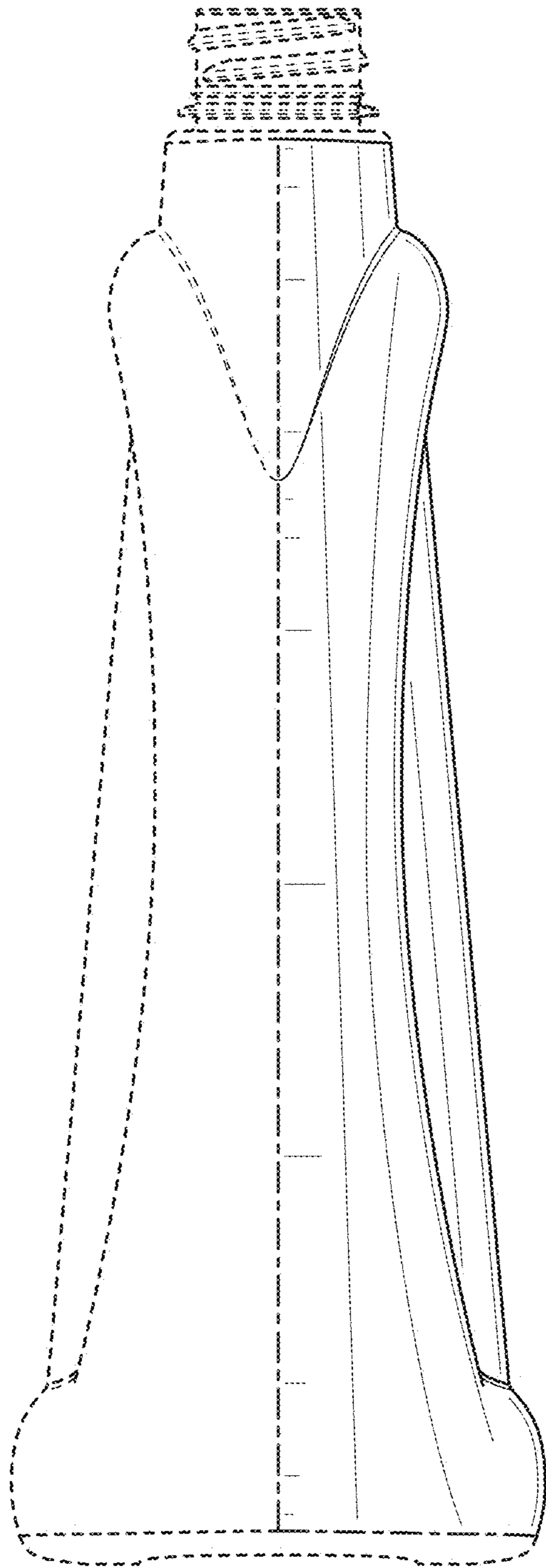

FIG. 11

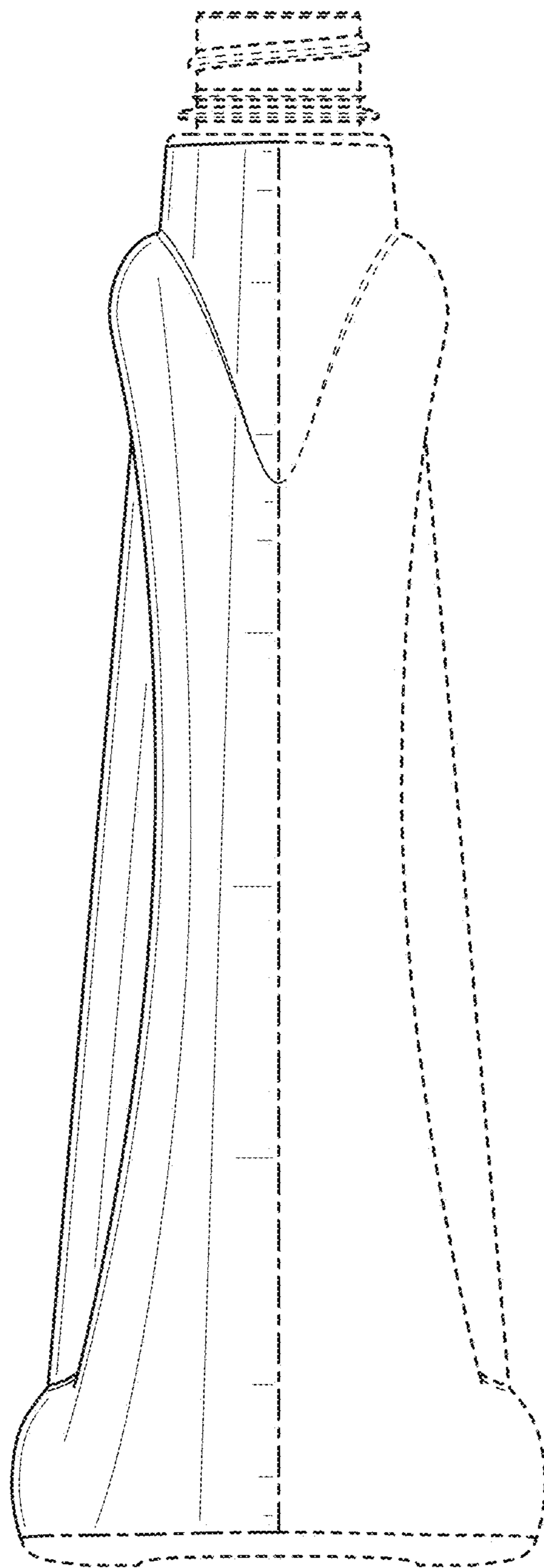

FIG. 12

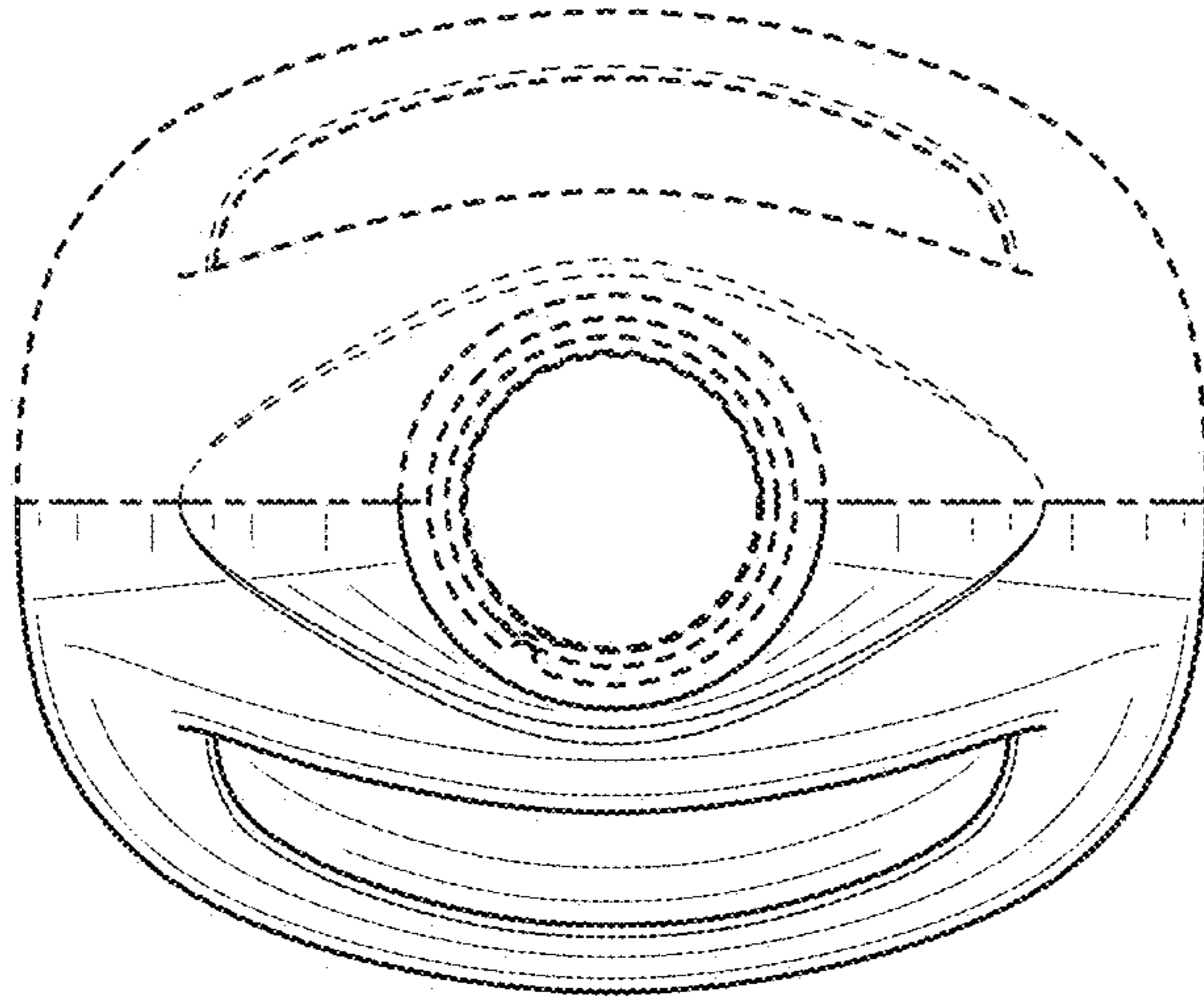

FIG. 13

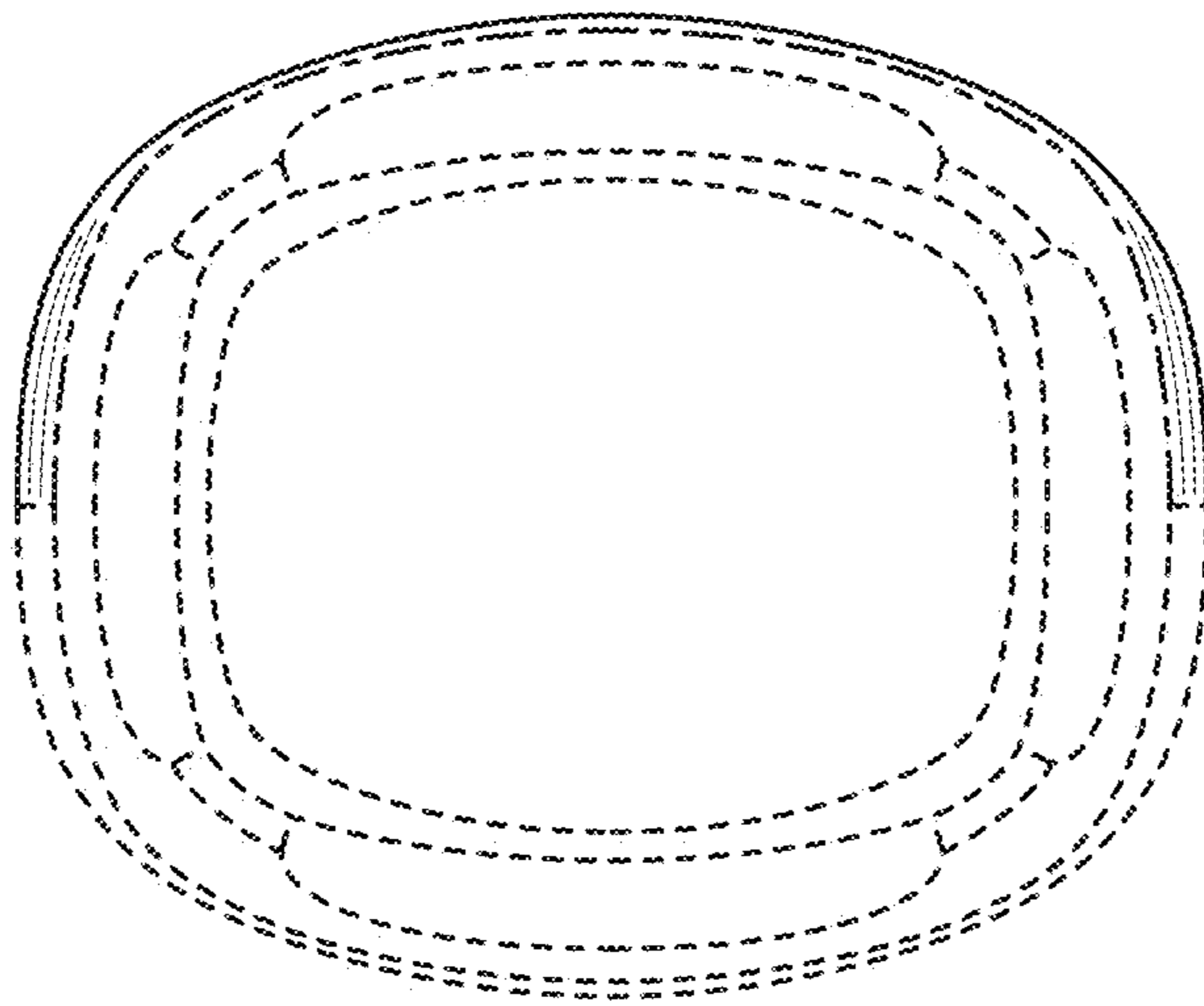

FIG. 14