



US00D721482S

(12) **United States Design Patent**
Simmons

(10) **Patent No.:** **US D721,482 S**
(45) **Date of Patent:** **** Jan. 27, 2015**

(54) **SOFT-SIDED GARMENT BAG BACKPACK**

(71) Applicant: **Dove Simmons**, Salem, MA (US)

(72) Inventor: **Dove Simmons**, Salem, MA (US)

(**) Term: **14 Years**

(21) Appl. No.: **29/478,336**

(22) Filed: **Jan. 3, 2014**

(51) **LOC (10) Cl.** **03-01**

(52) **U.S. Cl.**

USPC **D3/216; D3/217; D3/289**

(58) **Field of Classification Search**

CPC A45F 3/04; A45F 3/047; A45F 3/10;
A45F 3/14; A45F 4/02; A45F 4/08; A45F
2200/05; A45F 2200/0525; A45C 7/0095
USPC D3/201, 213-218, 231, 232, 267, 273,
D3/289, 327; 224/153, 155, 156, 191, 575,
224/576, 578, 581, 586, 613, 617, 627, 629,
224/630, 637, 644, 645, 650, 657; 441/80,
441/88; 5/413 R; 150/100, 106, 113;
206/287.1, 289

See application file for complete search history.

(56) **References Cited**

U.S. PATENT DOCUMENTS

1,742,656	A *	1/1930	Laprade	206/289
4,436,189	A	3/1984	Baum	
4,655,343	A *	4/1987	Lane et al.	206/287.1
4,887,751	A	12/1989	Lehman	
4,901,897	A *	2/1990	Briggs et al.	224/153
5,054,589	A	10/1991	Bomes et al.	
5,259,539	A *	11/1993	Brotman	224/630
5,562,204	A	10/1996	Sapyta et al.	
5,566,797	A	10/1996	Van Himbeeck	

5,628,398	A *	5/1997	Jackson	206/287.1
5,819,890	A	10/1998	Lin	
5,829,502	A *	11/1998	Distefano et al.	150/113
5,871,133	A *	2/1999	Robinson	224/634
5,881,932	A *	3/1999	Wadden	224/153
D506,864	S *	7/2005	Fonfeder	D3/217
6,976,566	B1	12/2005	Skriloff	
7,140,479	B2	11/2006	Mangano et al.	
7,165,705	B2 *	1/2007	Haro	224/629
D557,009	S *	12/2007	Elmberg et al.	D3/217
D651,794	S *	1/2012	Hargens et al.	D3/232
8,157,068	B2	4/2012	Sapyta	
D674,591	S *	1/2013	Hargens et al.	D3/217
8,453,896	B1	6/2013	Mansell	
D690,502	S *	10/2013	Bergquist	D3/217
D693,570	S *	11/2013	Rathbun	D3/217
2012/0267411	A1 *	10/2012	Rathbun	224/650

* cited by examiner

Primary Examiner — Martie K Holtje

(74) *Attorney, Agent, or Firm* — Lambert & Associates;
Gary E. Lambert; David J. Connaughton, Jr.

(57) **CLAIM**

The ornamental design for a soft-sided garment bag backpack, as shown and described.

DESCRIPTION

FIG. 1 is a front perspective view of a soft-sided garment bag backpack showing my new design in an open position; FIG. 2 is a rear perspective view thereof; FIG. 3 is a rear elevational view thereof; FIG. 4 is a front elevational view thereof; FIG. 5 is a top plan view thereof; FIG. 6 is a bottom plan view thereof; FIG. 7 is a right side elevational view thereof; and, FIG. 8 is a left side elevational view thereof.

1 Claim, 4 Drawing Sheets

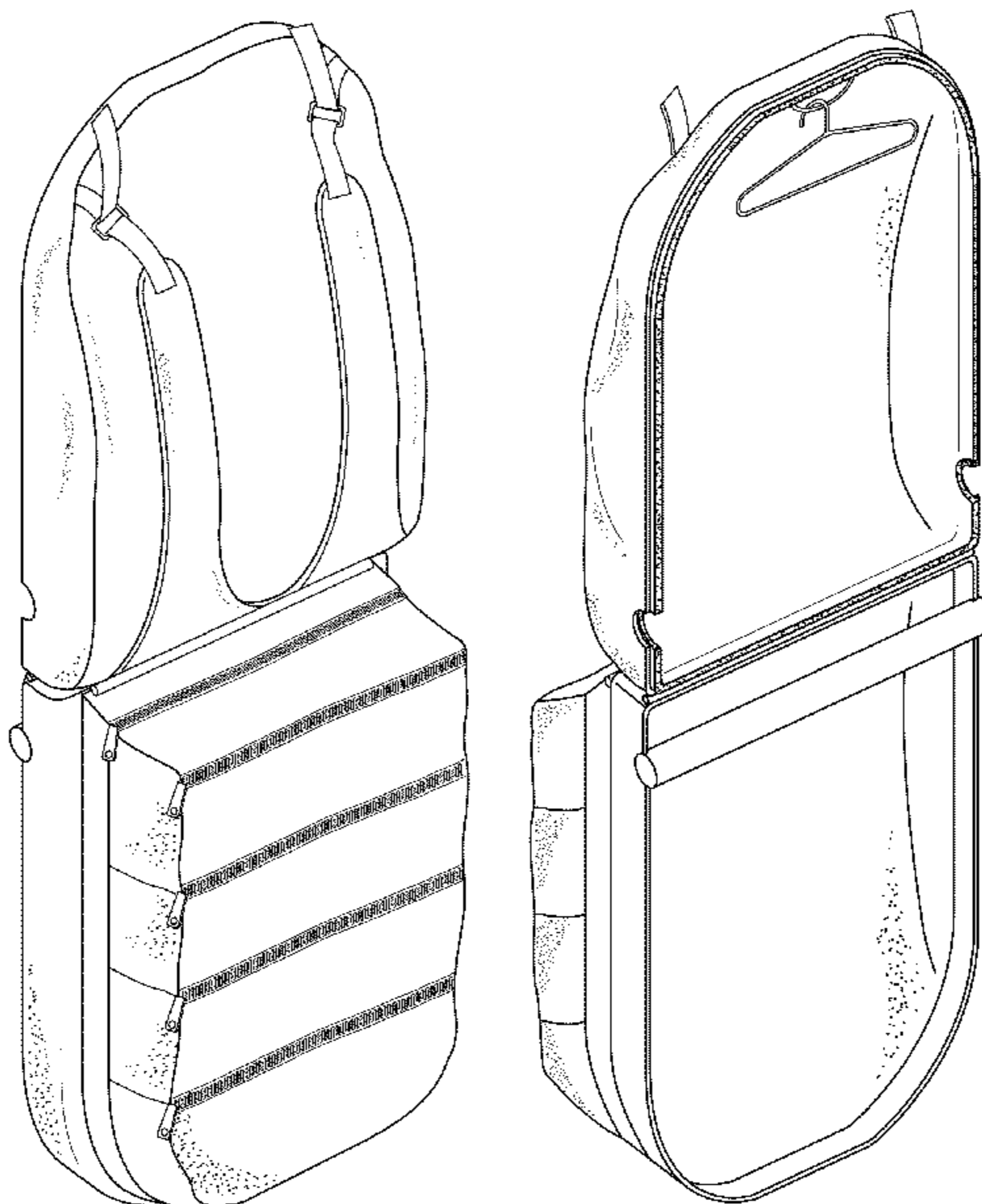

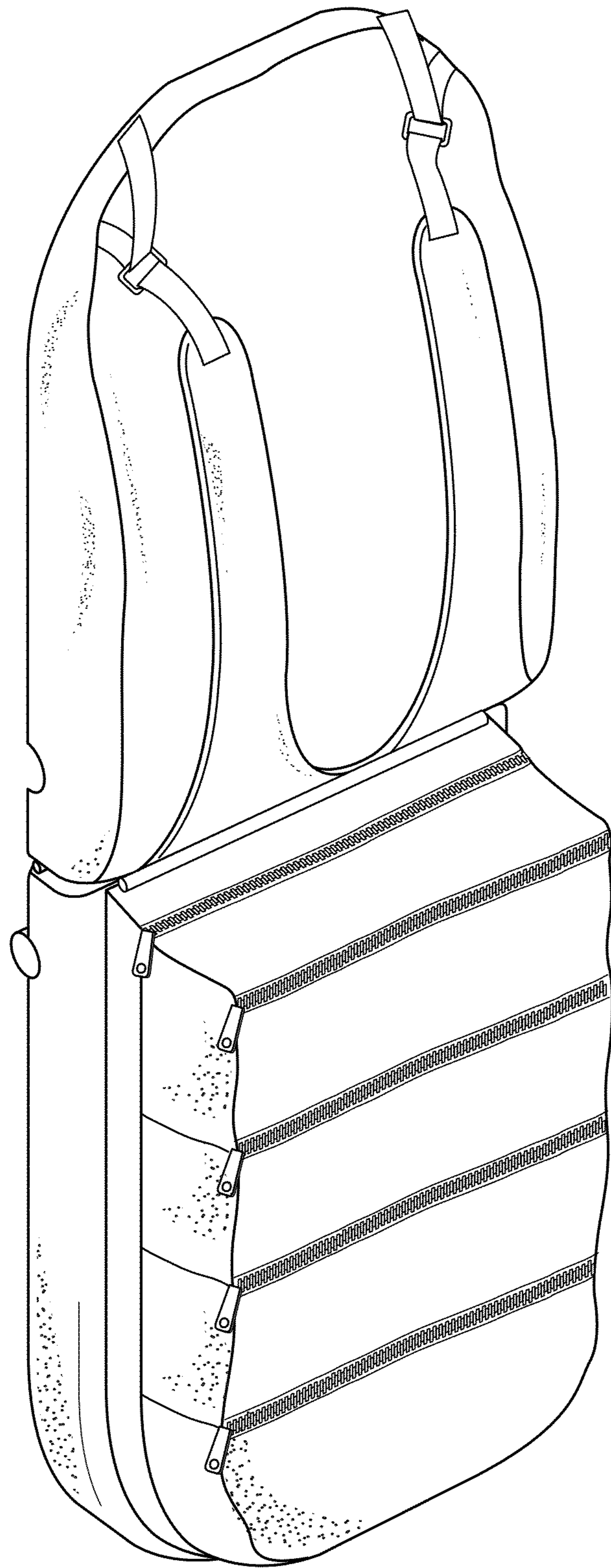

Fig. 1

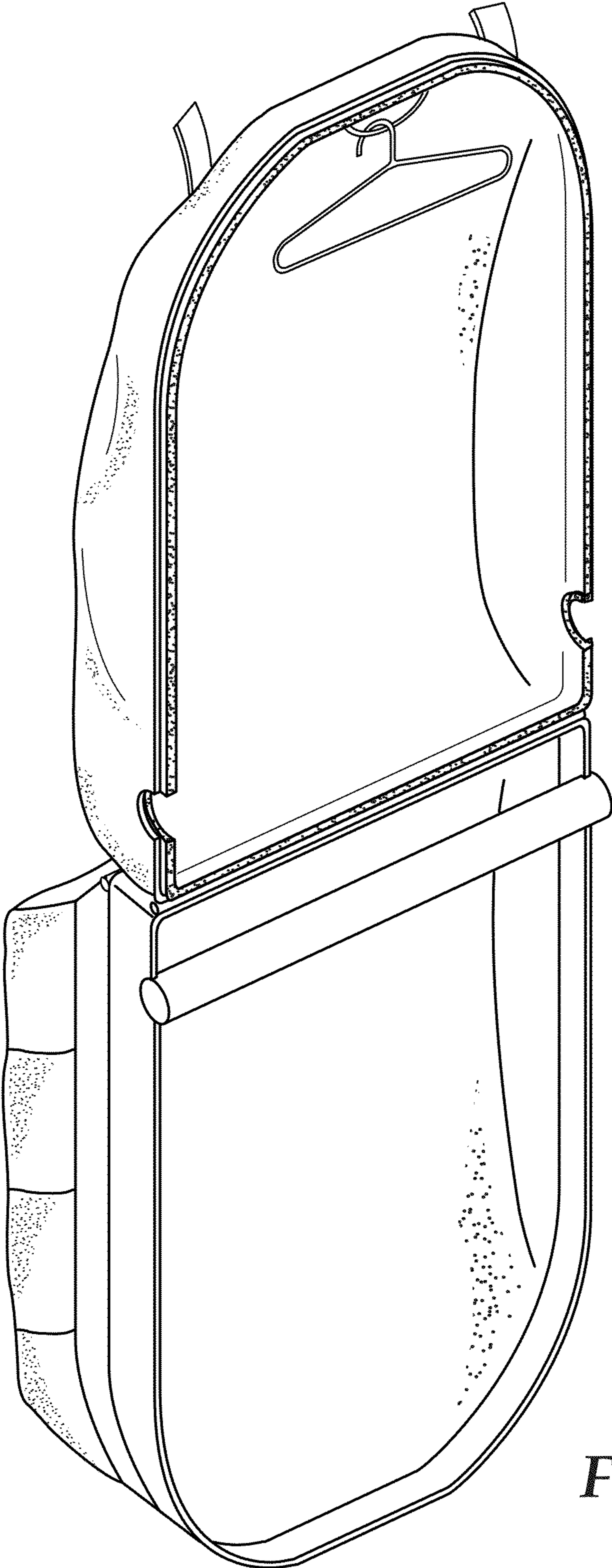

Fig. 2

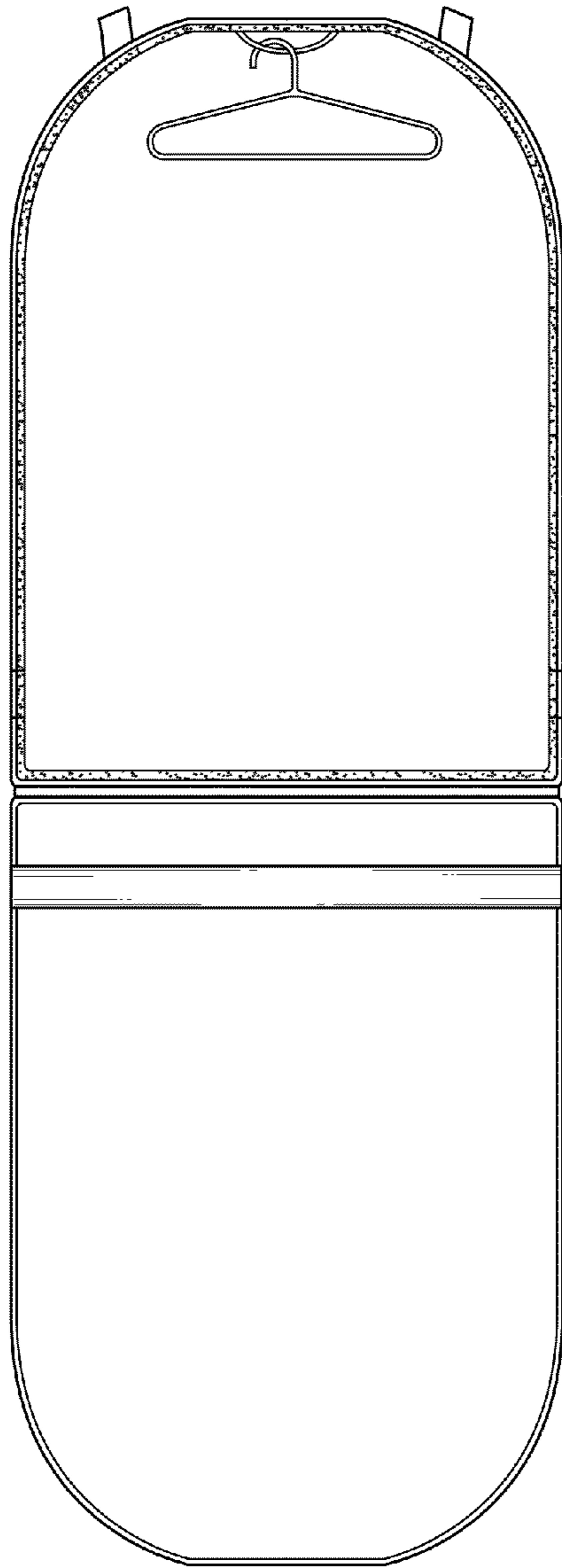

Fig. 3

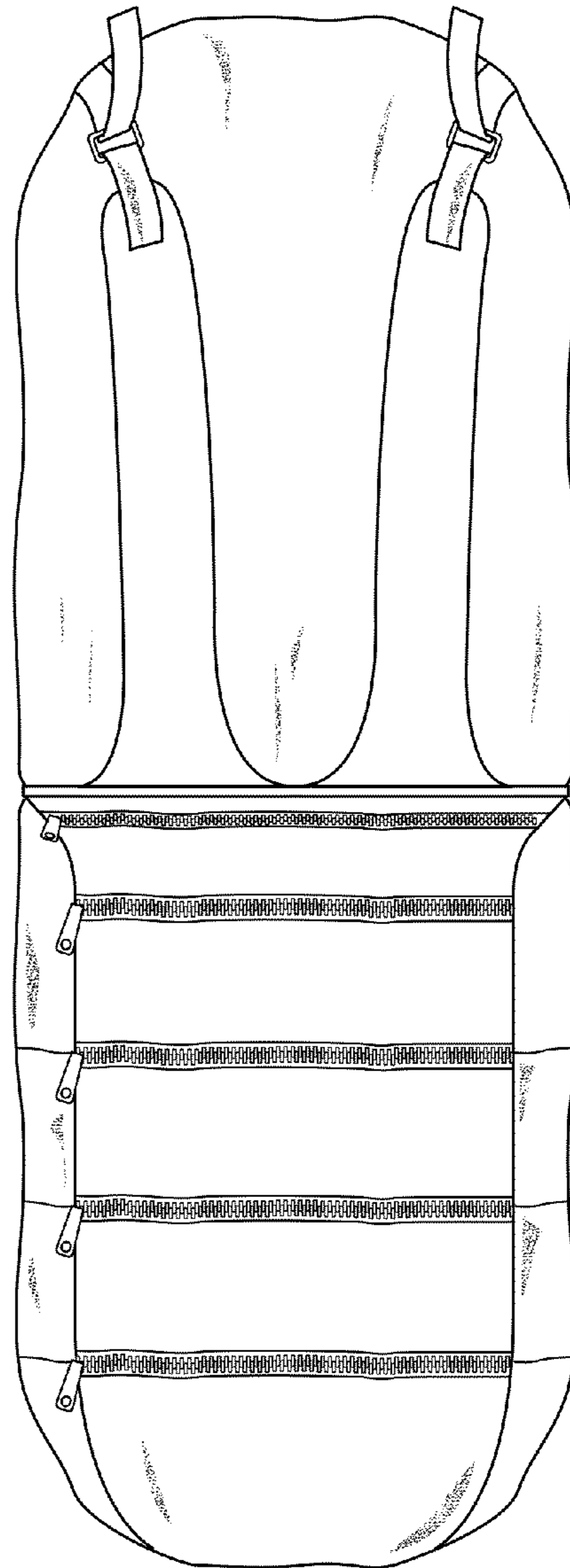

Fig. 4

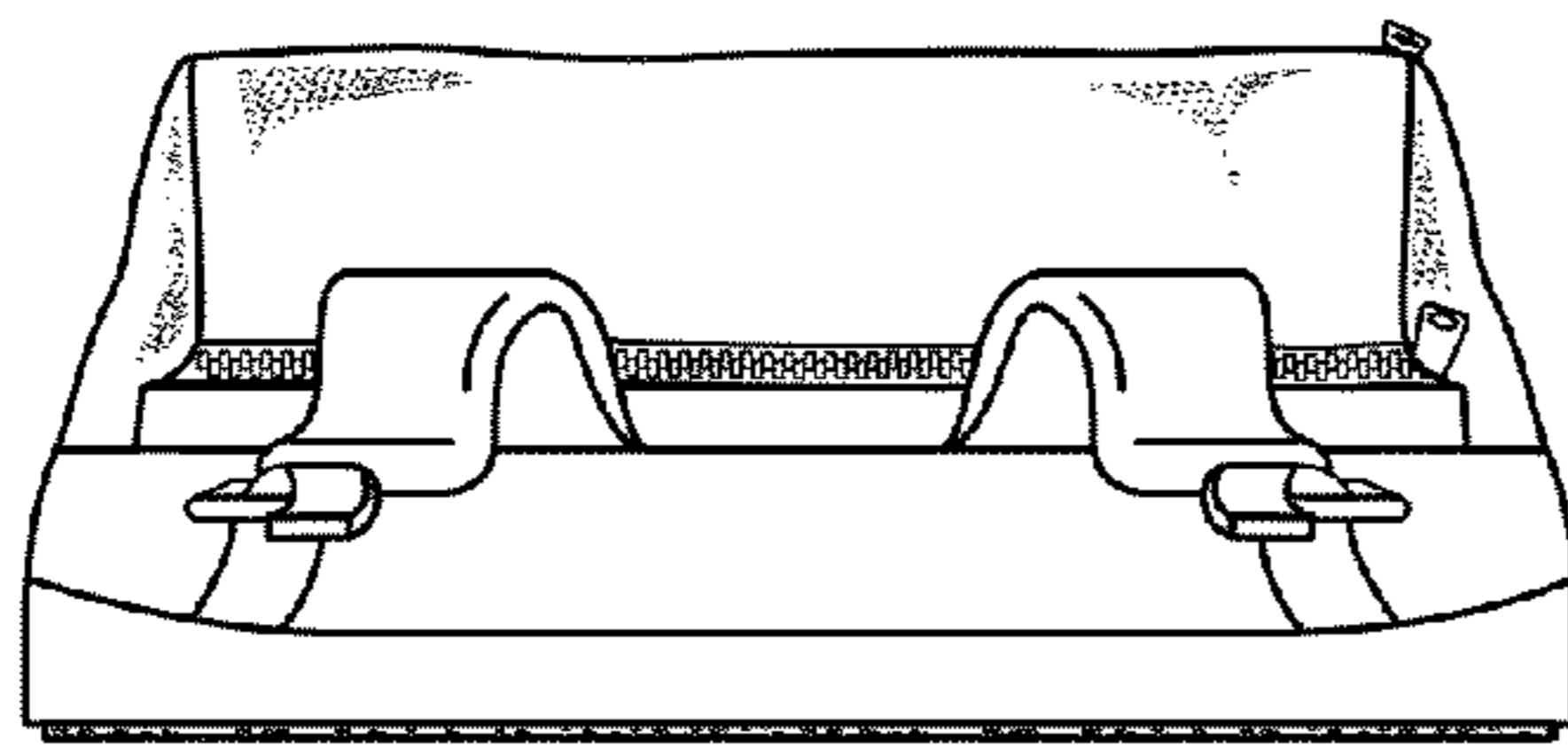

Fig. 5

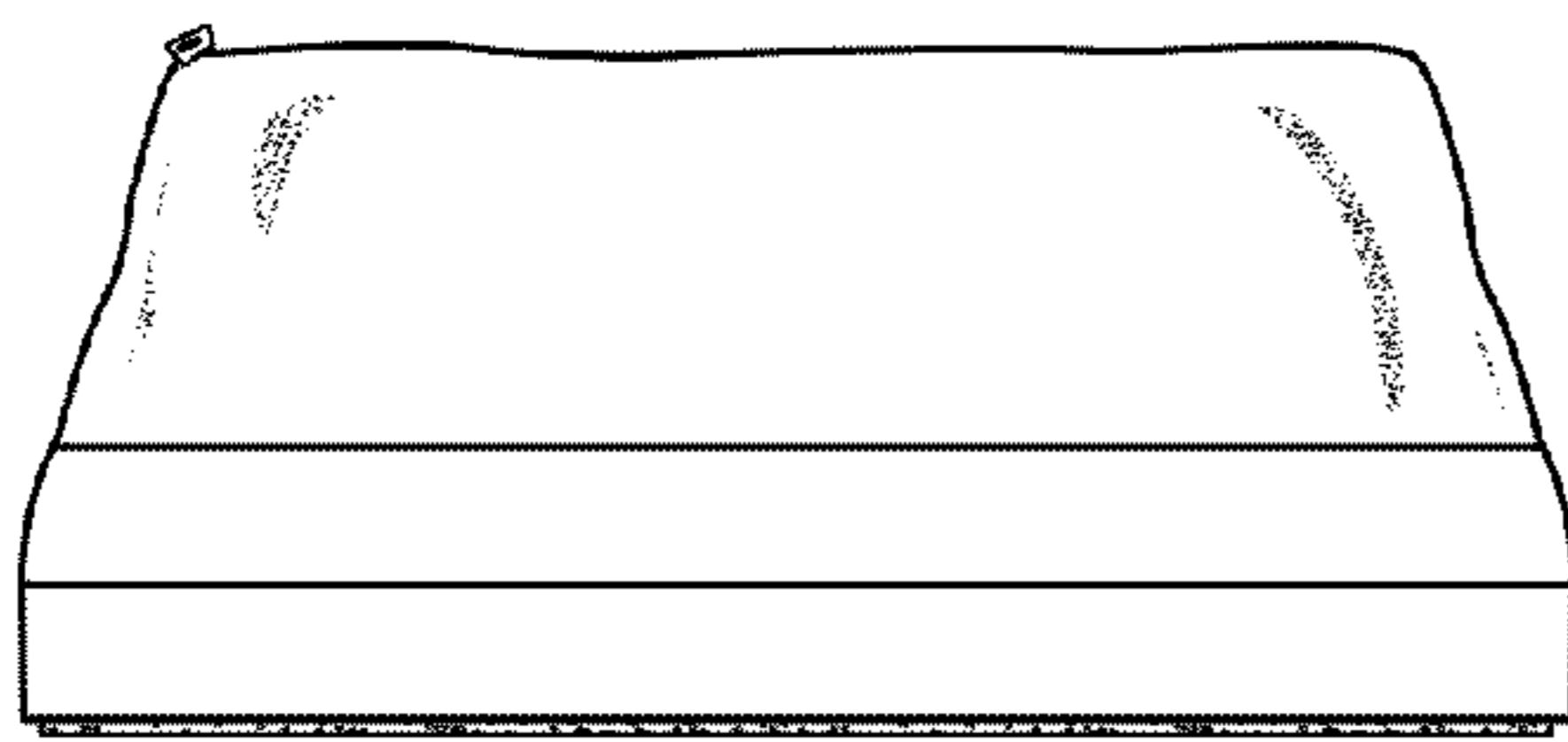

Fig. 6

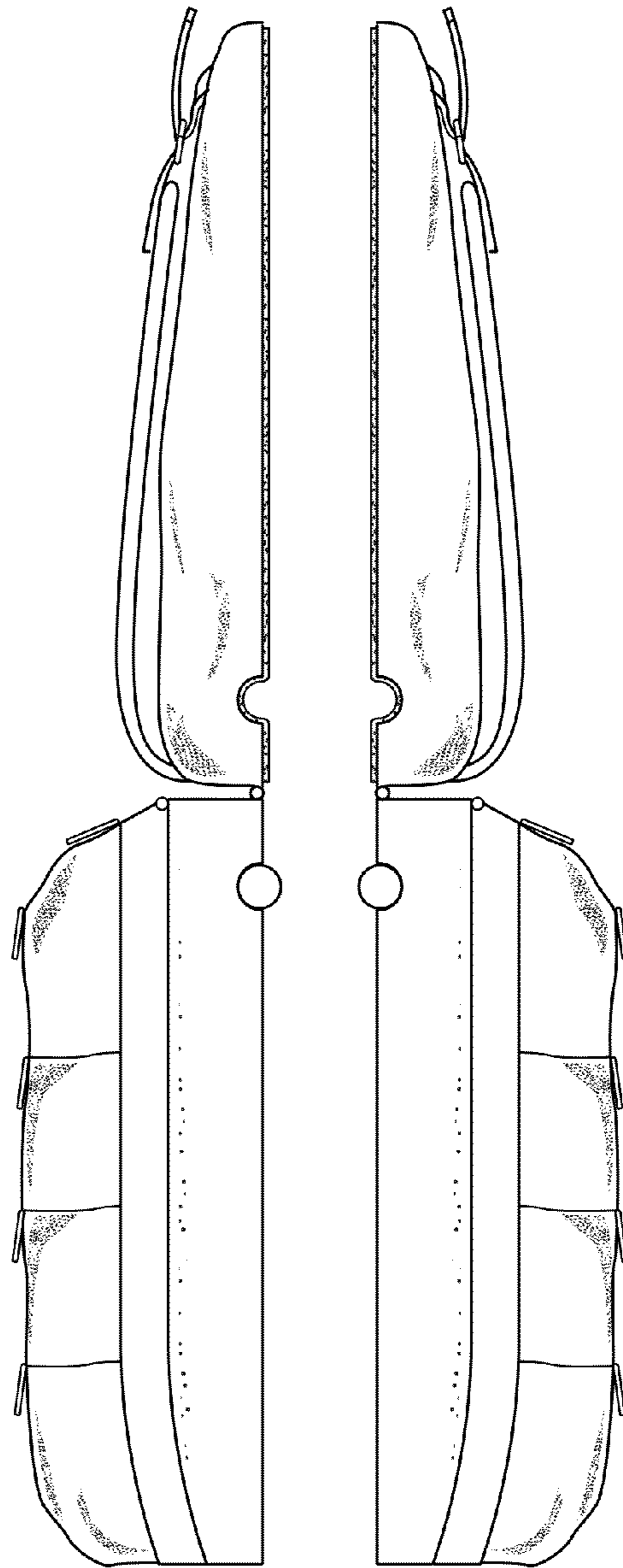

Fig. 7

Fig. 8