



US00D721420S

(12) **United States Design Patent**
Hawkins

(10) **Patent No.:** **US D721,420 S**
(45) **Date of Patent:** **** Jan. 20, 2015**

(54) **ANIMAL PAW HANDHELD SHOWERHEAD**

(71) Applicant: **Fan FI International, Inc.**, Reno, NV (US)

(72) Inventor: **Travis Hawkins**, Reno, NV (US)

(**) Term: **14 Years**

(21) Appl. No.: **29/475,459**

(22) Filed: **Dec. 3, 2013**

(51) **LOC (10) Cl.** **23-01**

(52) **U.S. Cl.**
USPC **D23/223; D24/215**

(58) **Field of Classification Search**
CPC B05B 1/18; B05B 1/00
USPC D23/213, 223; 239/462, 282-283;
4/615; D24/215

See application file for complete search history.

(56) **References Cited**

U.S. PATENT DOCUMENTS

D255,920	S	*	7/1980	Antonell	D23/215
4,353,139	A	*	10/1982	Wainwright et al.	4/661
5,172,860	A	*	12/1992	Yuch	239/71
5,505,380	A	*	4/1996	Jun	239/211
D676,927	S	*	2/2013	Svendsen et al.	D23/223
D691,699	S	*	10/2013	Berger et al.	D23/213
D700,281	S	*	2/2014	Bollerod	D23/213

* cited by examiner

Primary Examiner — Robin V Webster

(74) *Attorney, Agent, or Firm* — Russo & Duckworth, LLP; David G. Duckworth

(57) **CLAIM**

The ornamental design for an animal paw handheld showerhead, as shown and described.

DESCRIPTION

FIG. 1 is a top, left perspective view of the handheld showerhead of my design;
 FIG. 2 is a top, left perspective view thereof with a connection to a flexible hose;
 FIG. 3 is a front elevation view of the handheld showerhead;
 FIG. 4 is a rear elevation view thereof;
 FIG. 5 is a right elevation view thereof;
 FIG. 6 is a left elevation view thereof;
 FIG. 7 is a top plan view thereof; and,
 FIG. 8 is a bottom plan view thereof.

The broken lines shown represent unclaimed subject matter and form no part of the claimed design. Specifically, the flexible hose shown in FIG. 1 is for illustrative purposes and forms no part of the claimed design.

1 Claim, 4 Drawing Sheets

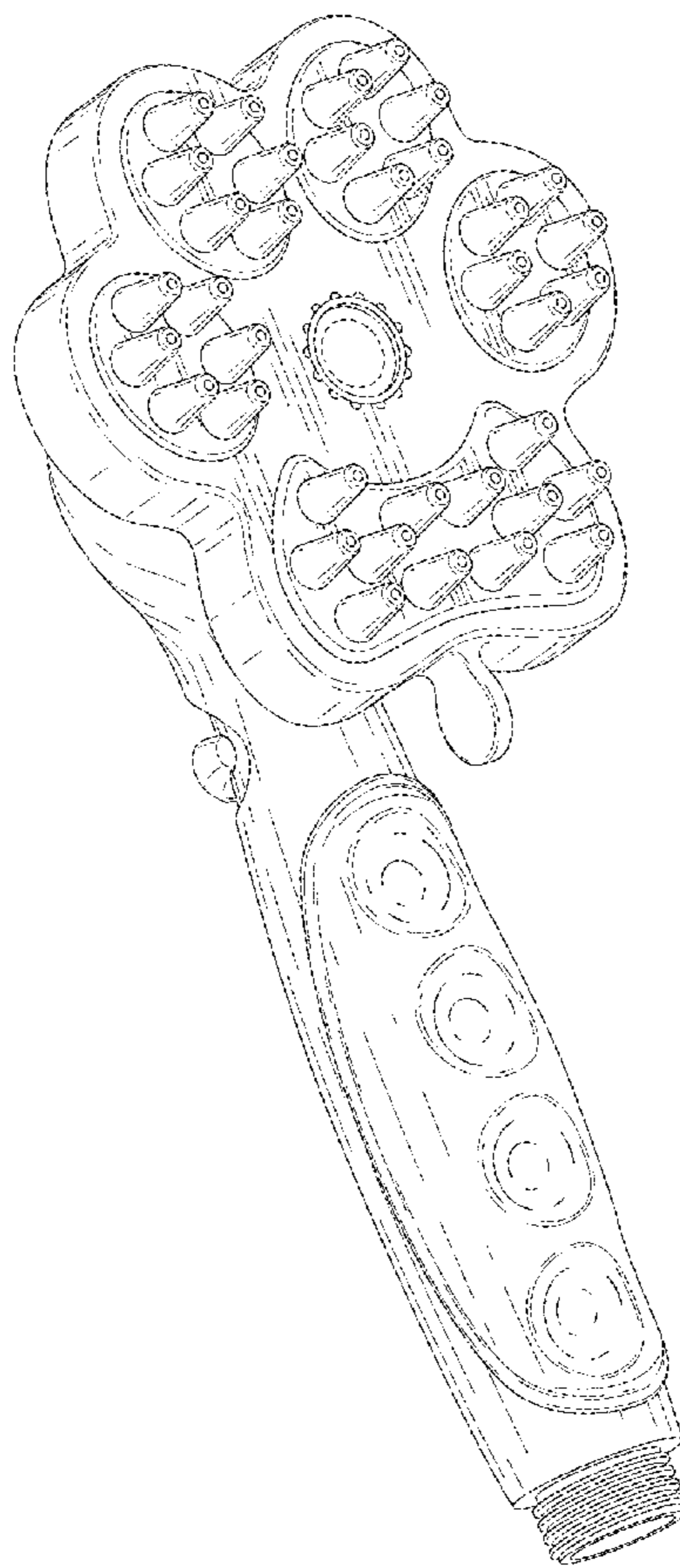

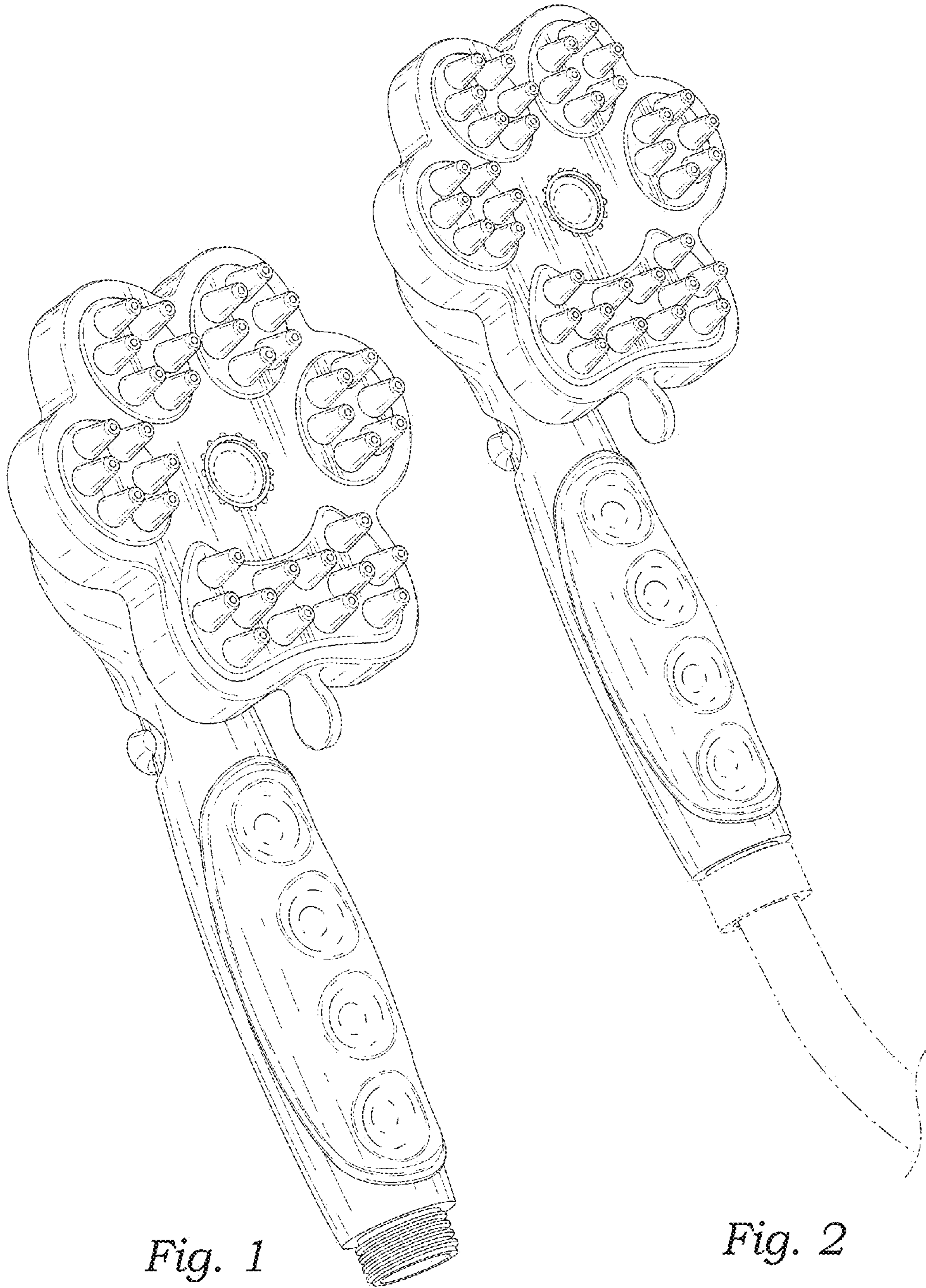

Fig. 1

Fig. 2

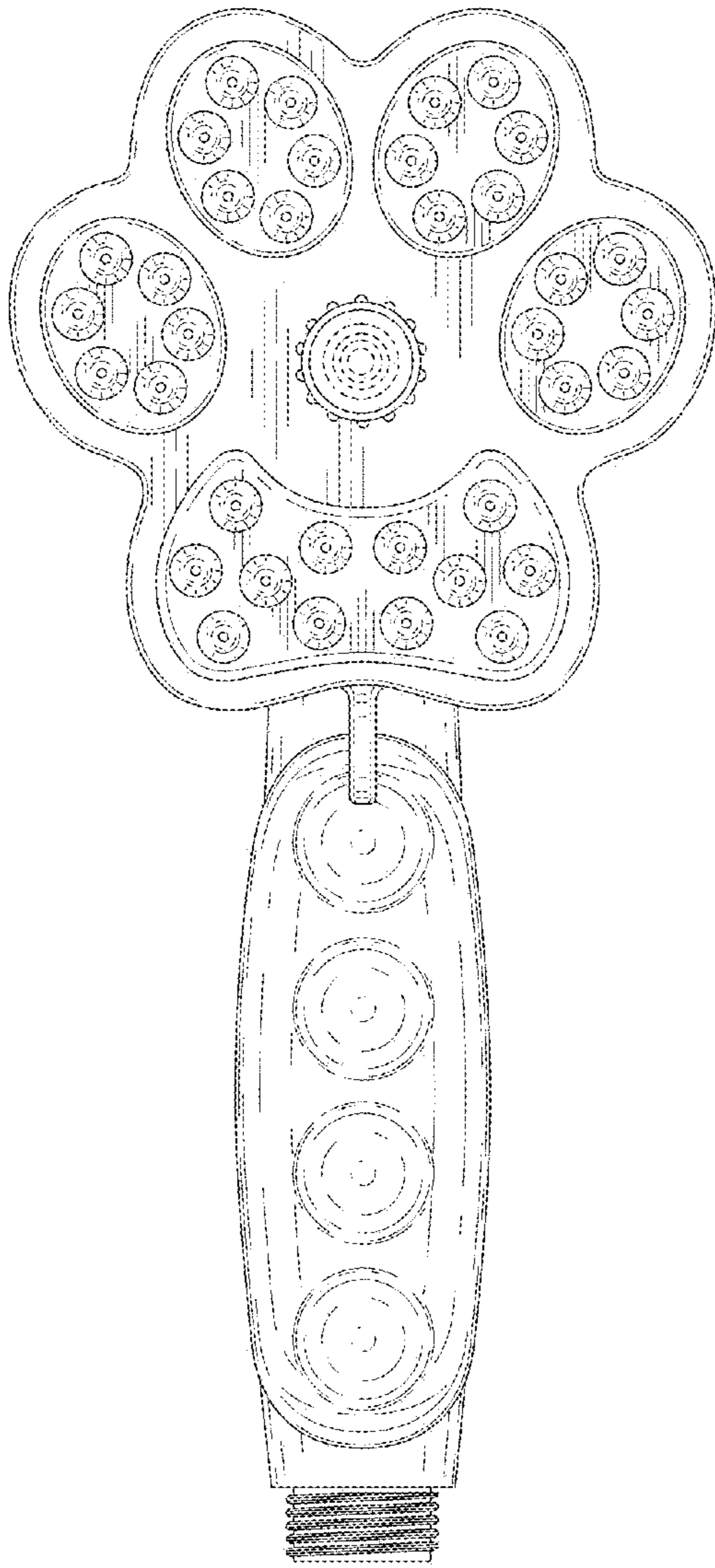

Fig. 3

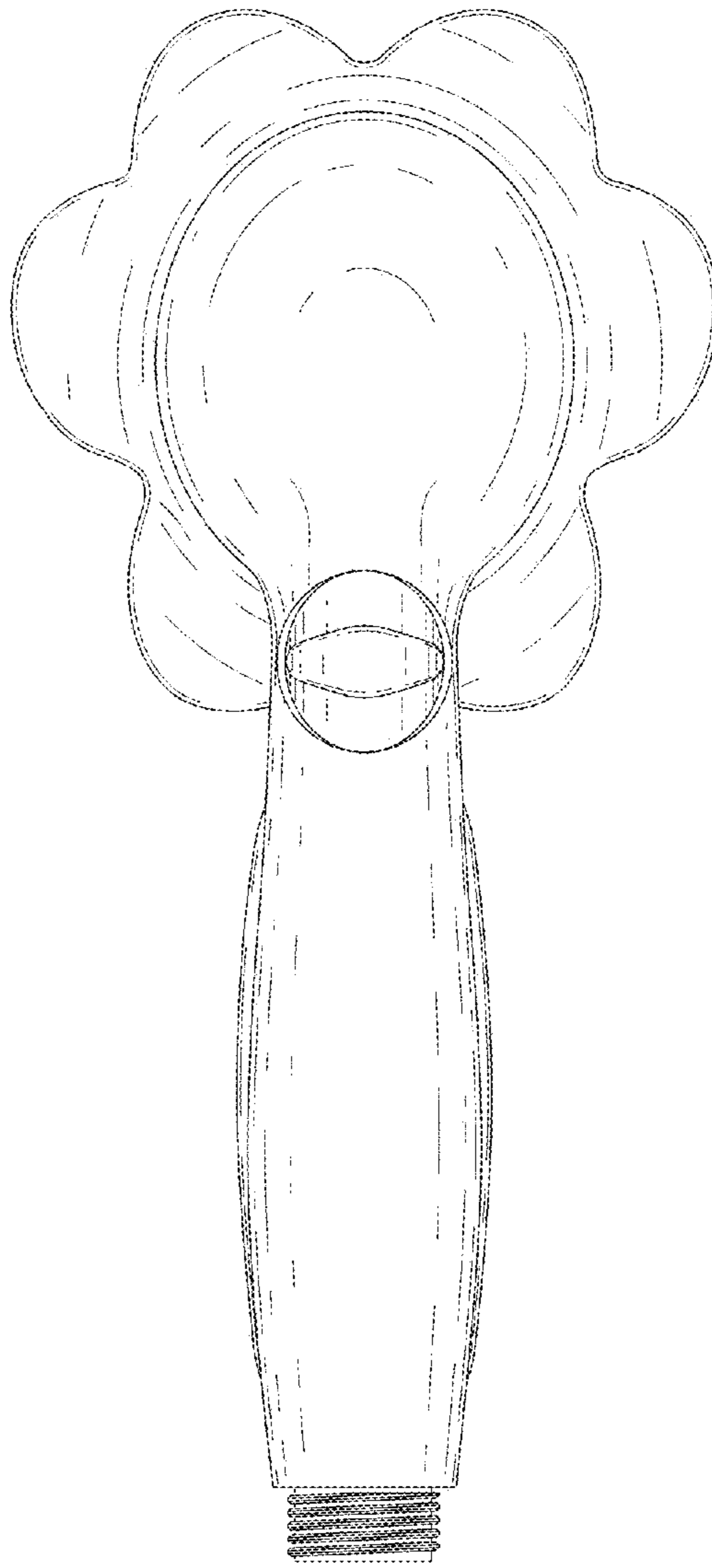

Fig. 4

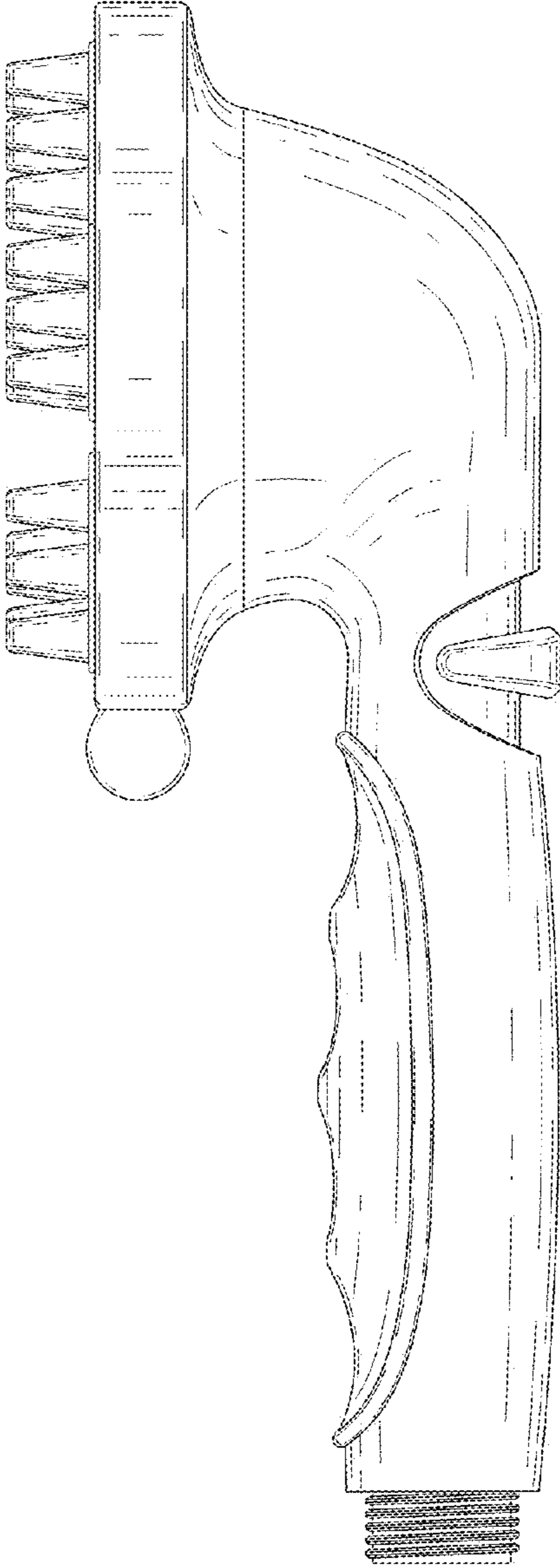

Fig. 5

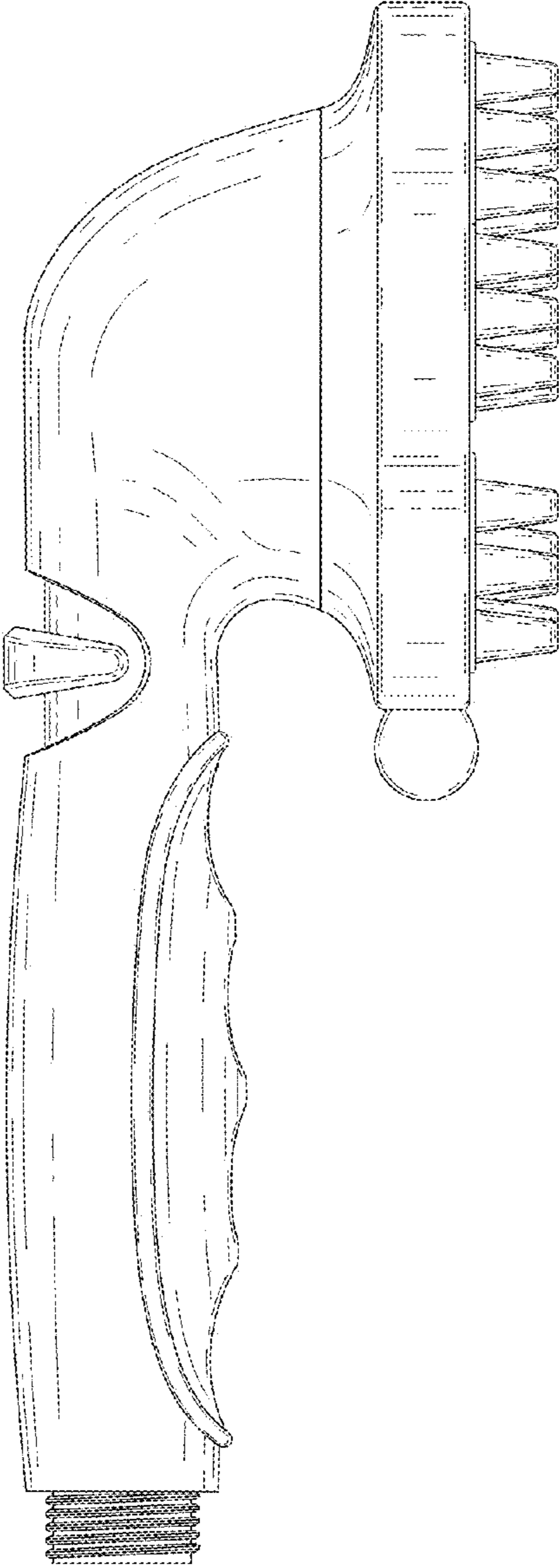

Fig. 6

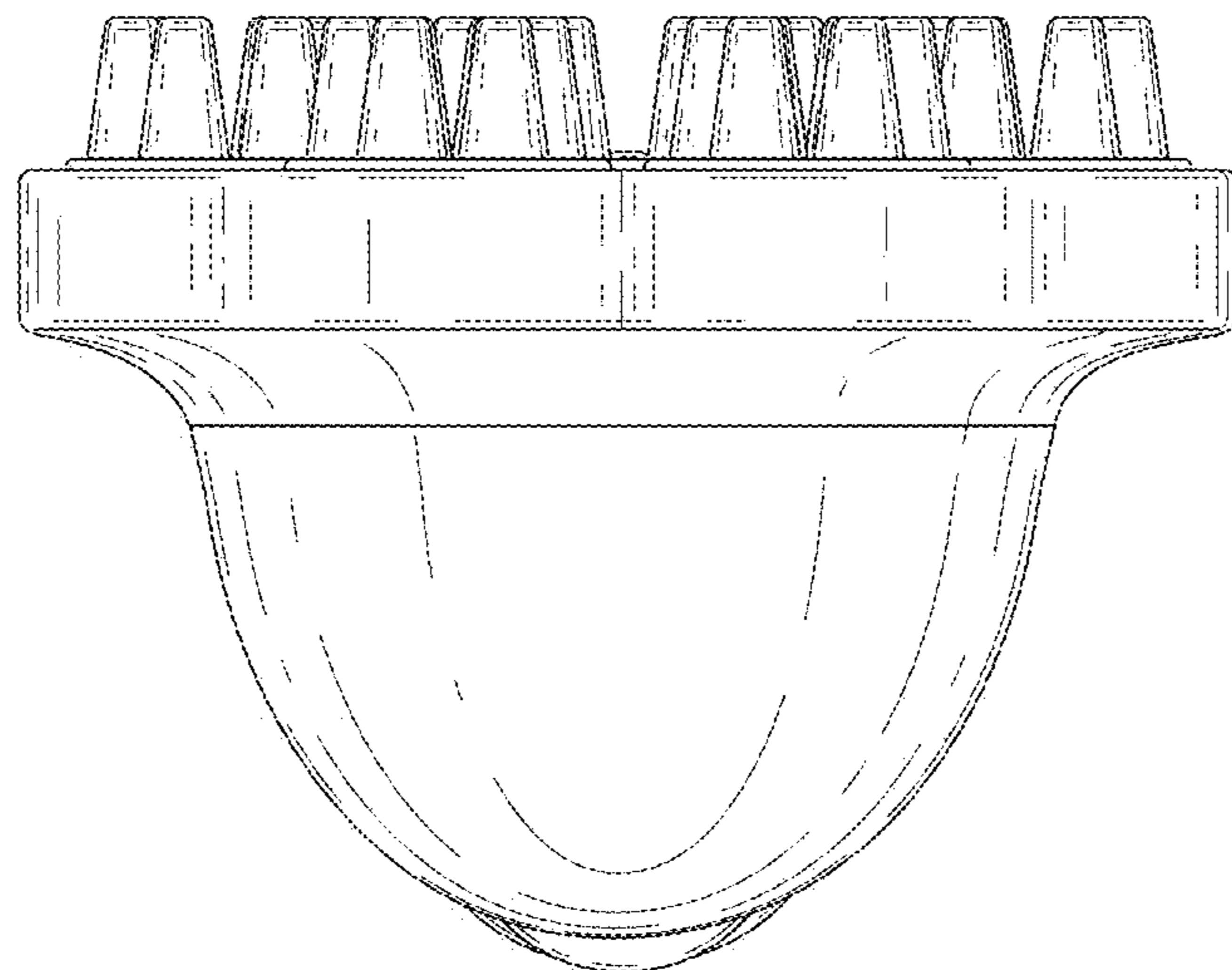

Fig. 7

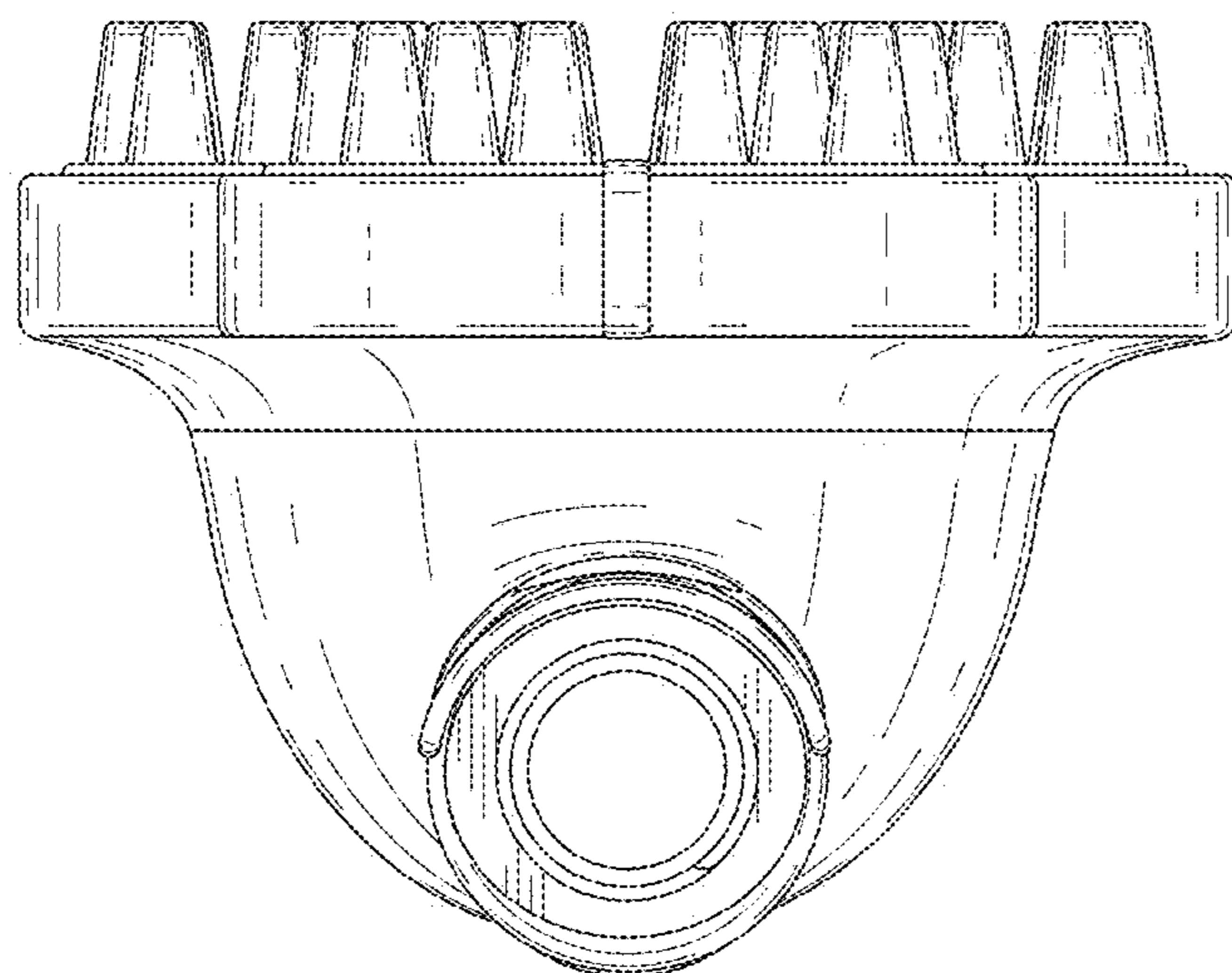

Fig. 8