



US00D721408S

(12) **United States Design Patent**
Fujioka et al.

(10) **Patent No.:** **US D721,408 S**
(45) **Date of Patent:** **** Jan. 20, 2015**

(54) **TRANSFORMABLE AND INTERCONNECTABLE TOY**

DESCRIPTION

(71) Applicants: **Robb Fujioka**, Manhattan Beach, CA (US); **Fuhu Holdings, Inc.**, El Segundo, CA (US)

(72) Inventors: **Robb Fujioka**, Manhattan Beach, CA (US); **Nicholas Stephen Berry**, Torrance, CA (US)

(**) Term: **14 Years**

(21) Appl. No.: **29/457,249**

(22) Filed: **Jun. 7, 2013**

(51) **LOC (10) Cl.** **21-01**

(52) **U.S. Cl.**

USPC **D21/579**; D21/584

(58) **Field of Classification Search**

USPC D6/598; D11/158; D21/576–585, 615, D21/650; 446/72–73, 97–98, 268, 369; D30/160

See application file for complete search history.

(56) **References Cited**

U.S. PATENT DOCUMENTS

D286,800 S *	11/1986	Maruyama	D21/584
D558,281 S *	12/2007	Sato et al.	D21/579
D564,048 S *	3/2008	Sato et al.	D21/584
D589,569 S *	3/2009	Sato et al.	D21/584
D590,453 S *	4/2009	Sato et al.	D21/584
D590,454 S *	4/2009	Sato et al.	D21/584
D590,455 S *	4/2009	Sato et al.	D21/584
D590,897 S *	4/2009	Sato et al.	D21/584

* cited by examiner

Primary Examiner — Sandra Morris

(74) *Attorney, Agent, or Firm* — Steptoe & Johnson LLP

(57) **CLAIM**

The ornamental design for a transformable and interconnectable toy, as shown and described.

FIGS. 1-3 are top perspective views of a transformable and interconnectable toy showing a new design, FIG. 1 showing a first portion of said toy, FIG. 2 showing a second portion of said toy, and FIG. 3 showing a third portion of said toy, each portion shown in a closed position;

FIGS. 4-6 are front elevation views thereof, FIG. 4 showing a first portion of said toy, FIG. 5 showing a second portion of said toy, and FIG. 6 showing a third portion of said toy, each portion shown in a closed position;

FIGS. 7-9 are back elevation views thereof, FIG. 7 showing a first portion of said toy, FIG. 8 showing a second portion of said toy, and FIG. 9 showing a third portion of said toy, each portion shown in a closed position;

FIGS. 10-12 are left side elevation views thereof, FIG. 10 showing a first portion of said toy, FIG. 11 showing a second portion of said toy, and FIG. 12 showing a third portion of said toy, each portion shown in a closed position;

FIGS. 13-15 are right side elevation views thereof, FIG. 13 showing a first portion of said toy, FIG. 14 showing a second portion of said toy, and FIG. 15 showing a third portion of said toy, each portion shown in a closed position;

FIGS. 16-18 are top elevation views thereof, FIG. 16 showing a first portion of said toy, FIG. 17 showing a second portion of said toy, and FIG. 18 showing a third portion of said toy, each portion shown in a closed position;

FIGS. 19-21 are bottom elevation views thereof, FIG. 19 showing a first portion of said toy, FIG. 20 showing a second portion of said toy, and FIG. 21 showing a third portion of said toy, each portion shown in a closed position;

FIGS. 22-24 are top perspective views thereof, FIG. 22 showing a first portion of said toy, FIG. 23 showing a second portion of said toy, and FIG. 24 showing a third portion of said toy, each portion shown in an open position and interconnected to an adjacent portion;

FIGS. 25-27 are top perspective views thereof, FIG. 25 showing a first portion of said toy, FIG. 26 showing a second portion of said toy, and FIG. 27 showing a third portion of said toy, each portion shown in an open position and not interconnected to an adjacent portion;

FIG. 28 is a front elevation view of the first, second, and third portions in an open position and interconnected to an adjacent portion;

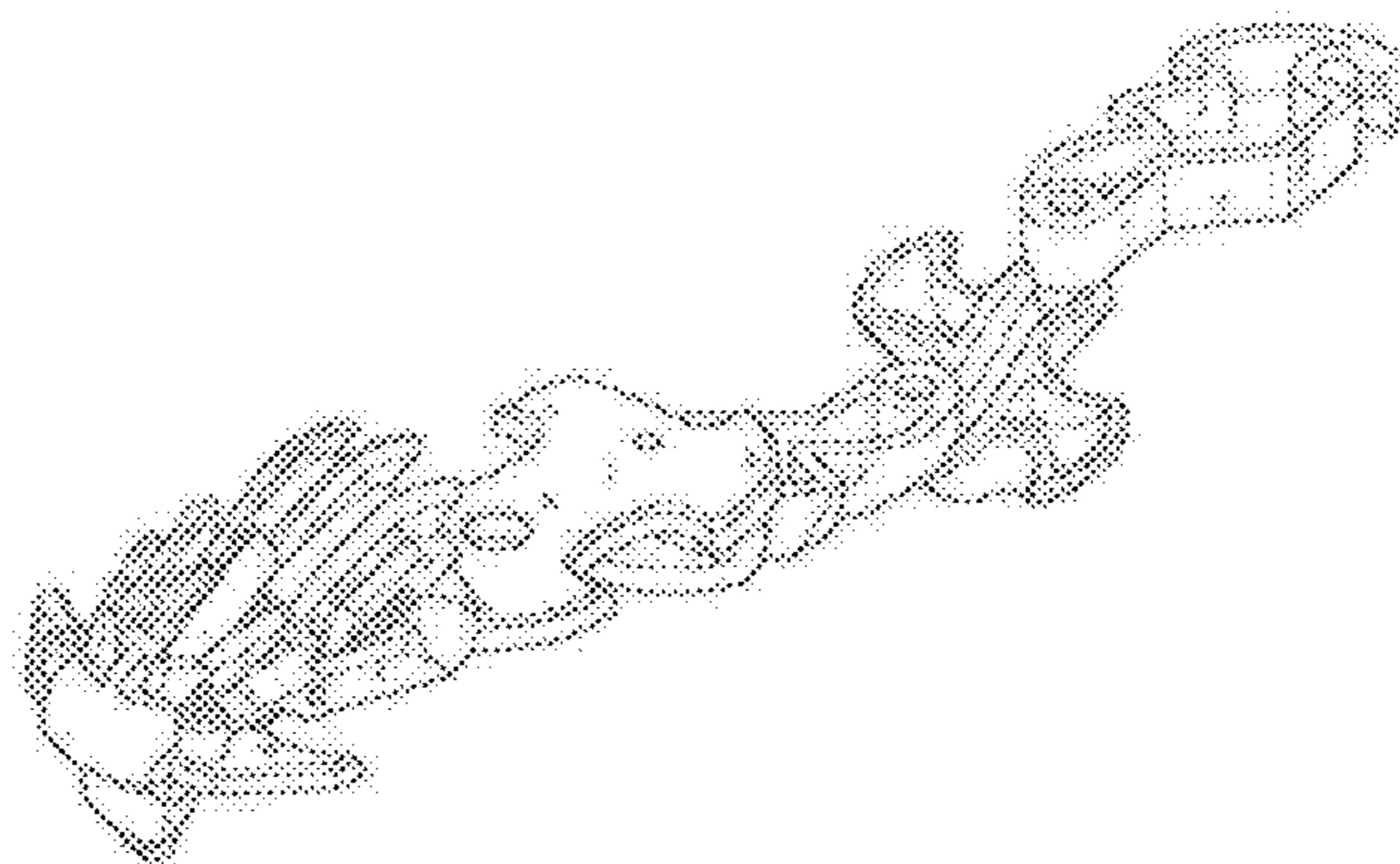
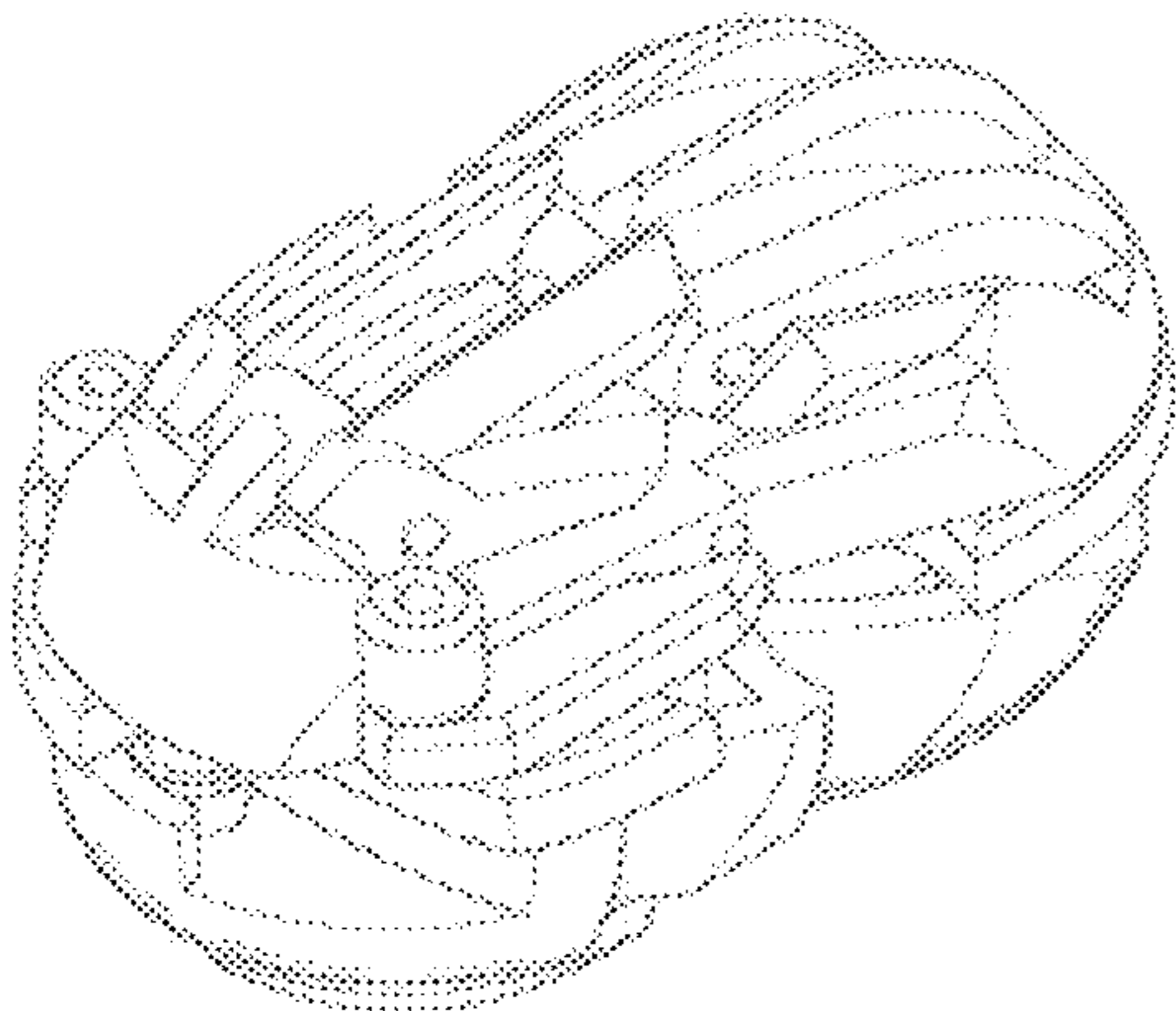

FIGS. **29-31** are front elevation views thereof, FIG. **29** showing a first portion of said toy, FIG. **30** showing a second portion of said toy, and FIG. **31** showing a third portion of said toy, each portion shown in an open position;

FIG. **32** is a back elevation view of the first, second, and third portions in an open position and interconnected to an adjacent portion;

FIGS. **33-35** are back elevation views thereof, FIG. **33** showing a first portion of said toy, FIG. **34** showing a second portion of said toy, and FIG. **35** showing a third portion of said toy, each portion shown in an open position;

FIG. **36** is a right side elevation view of the first, second, and third portions in an open position and interconnected to an adjacent portion;

FIG. **37** is a left side elevation view of the first, second, and third portions in an open position and interconnected to an adjacent portion;

FIG. **38** is a top elevation view of the first, second, and third portions in an open position and interconnected to an adjacent portion; and,

FIG. **39** is a bottom elevation view of the first, second, and third portions in an open position and interconnected to an adjacent portion.

1 Claim, 10 Drawing Sheets

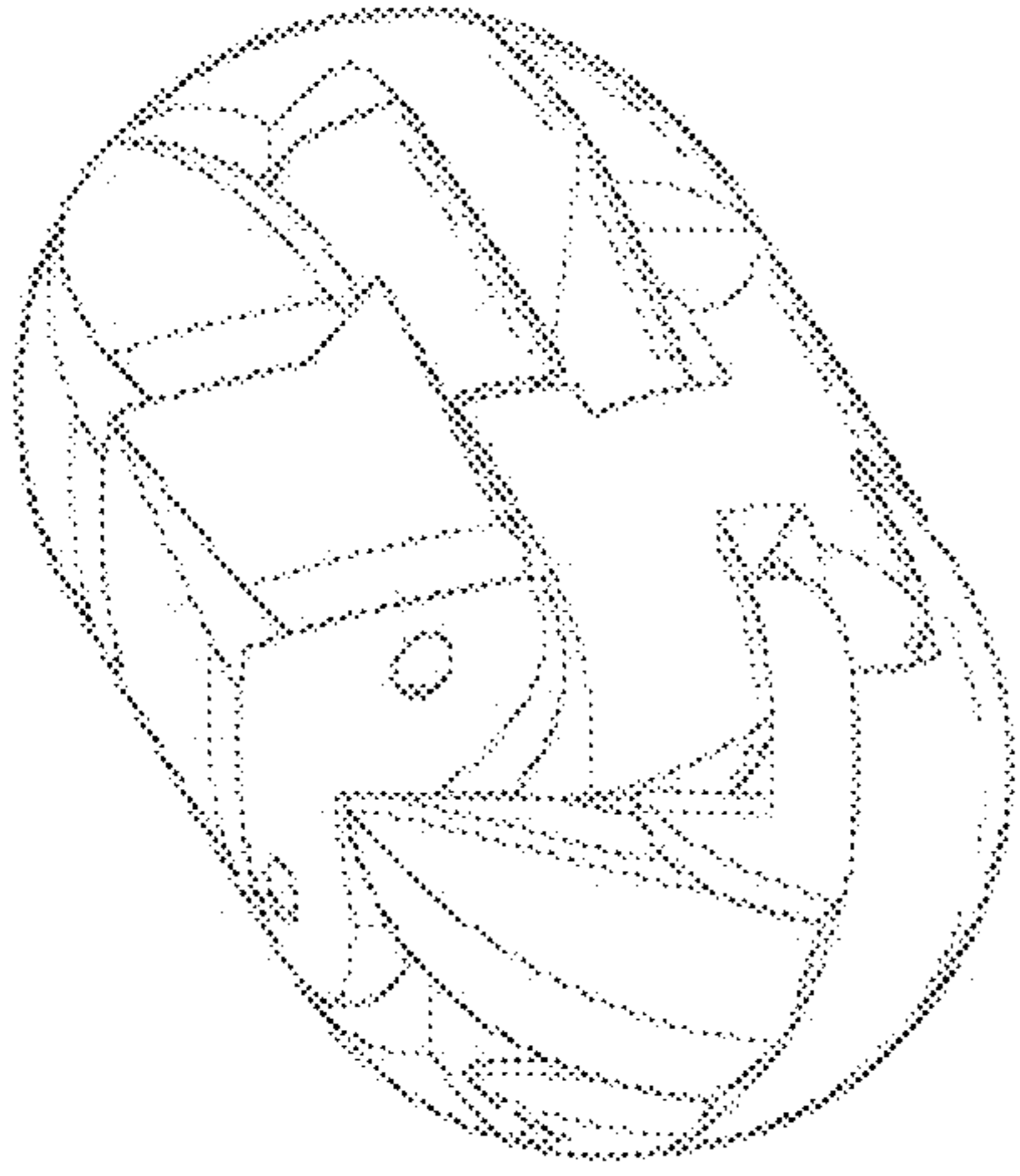

Fig. 3

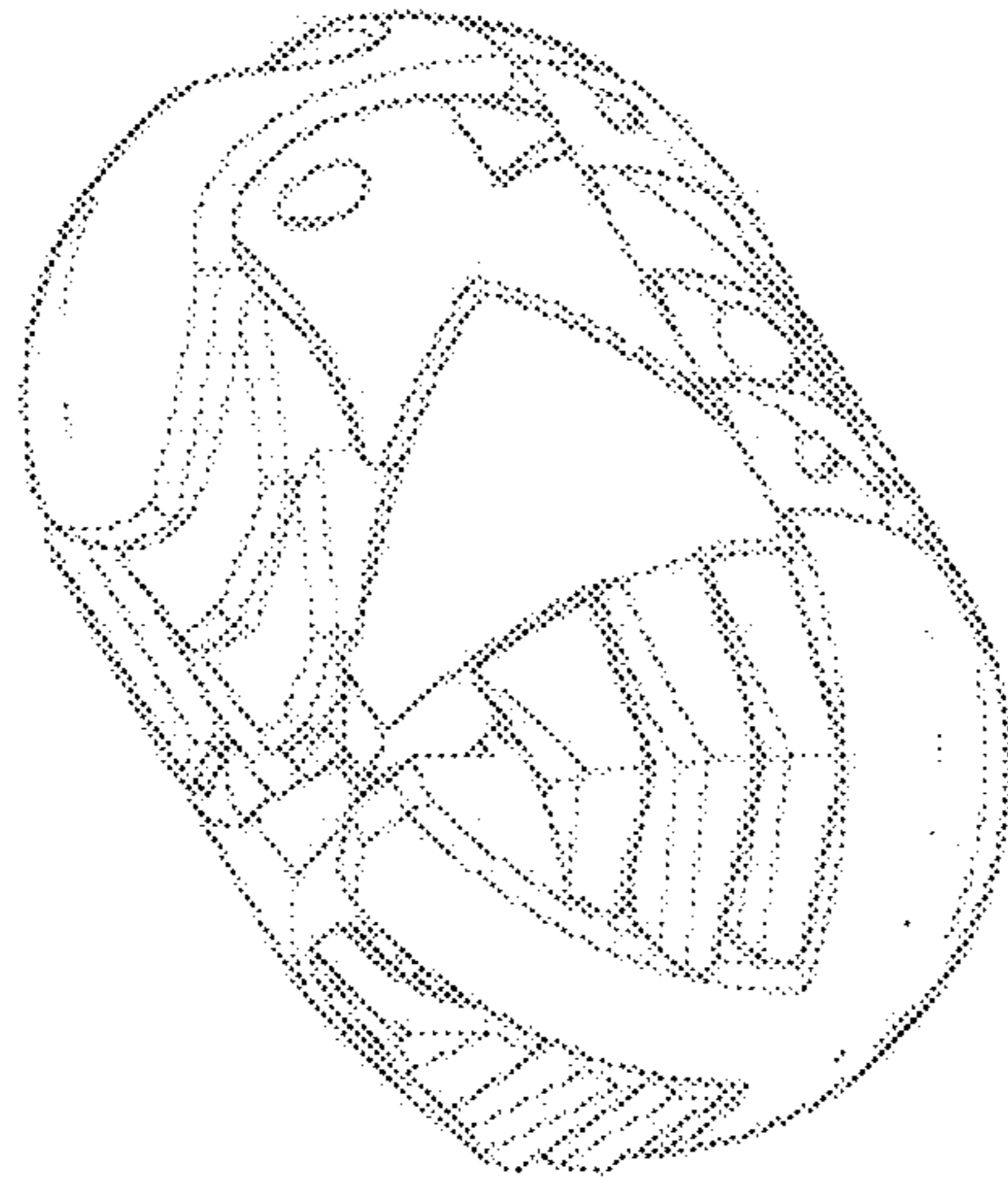

Fig. 2

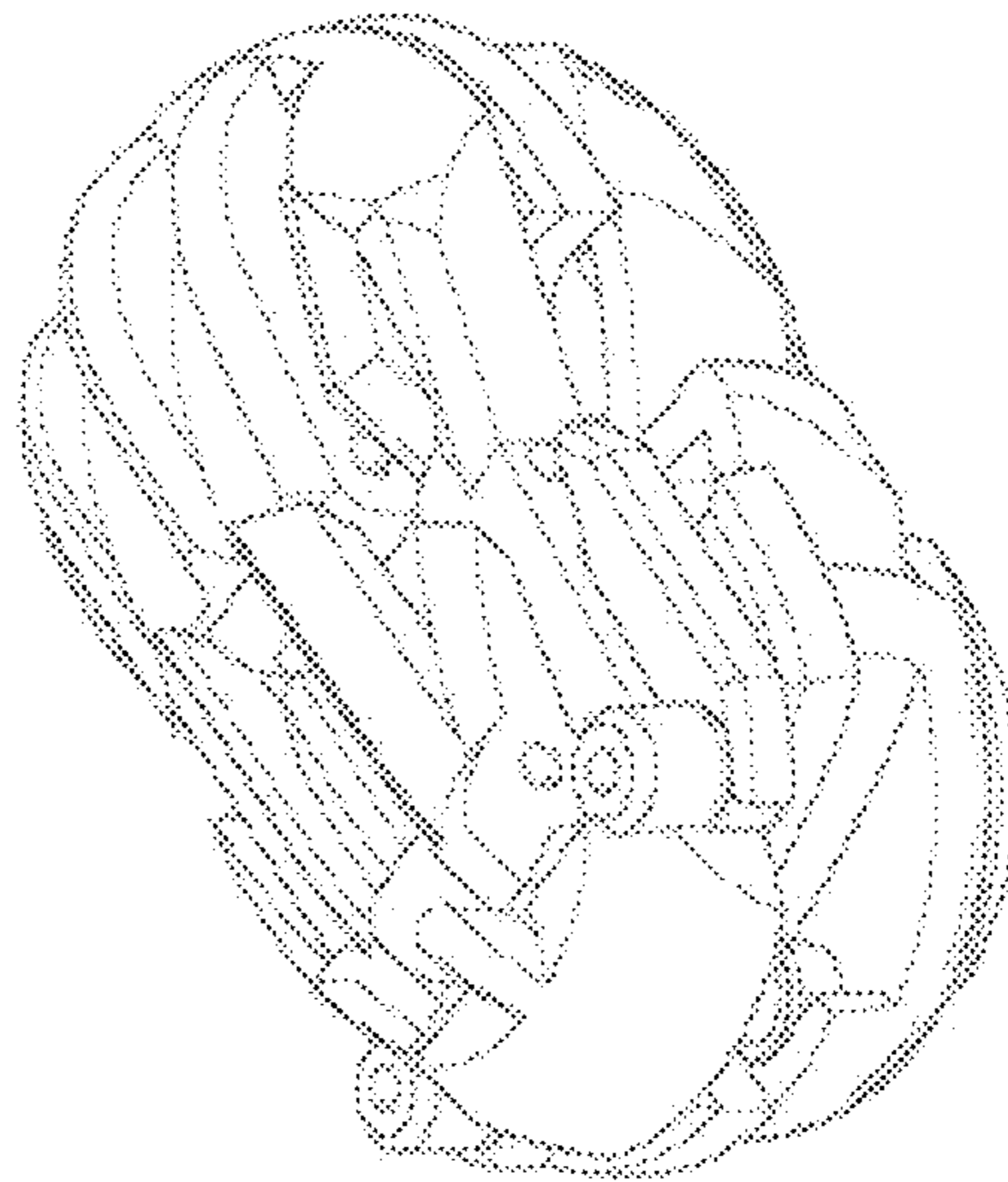

Fig. 1

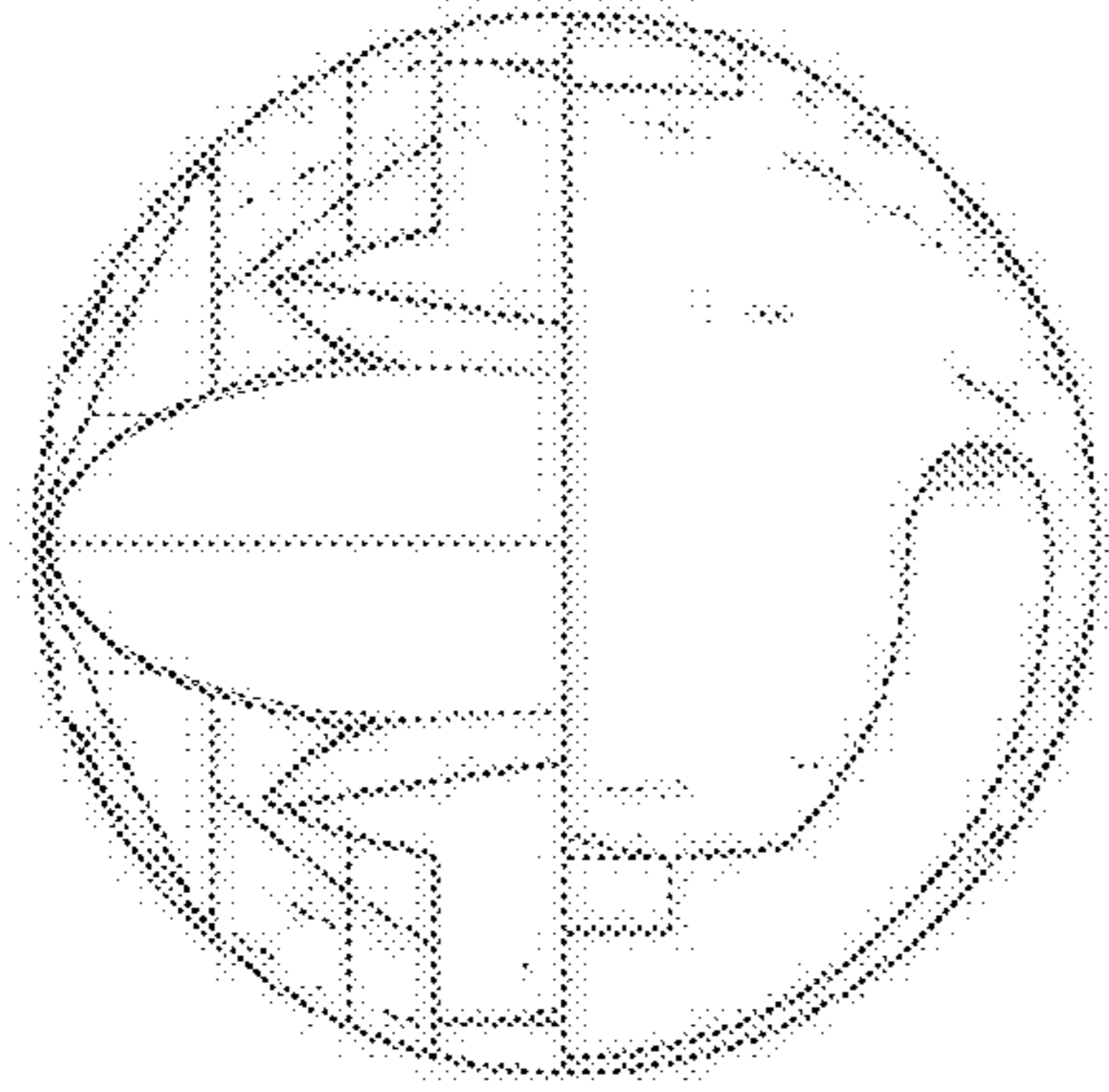

Fig. 6

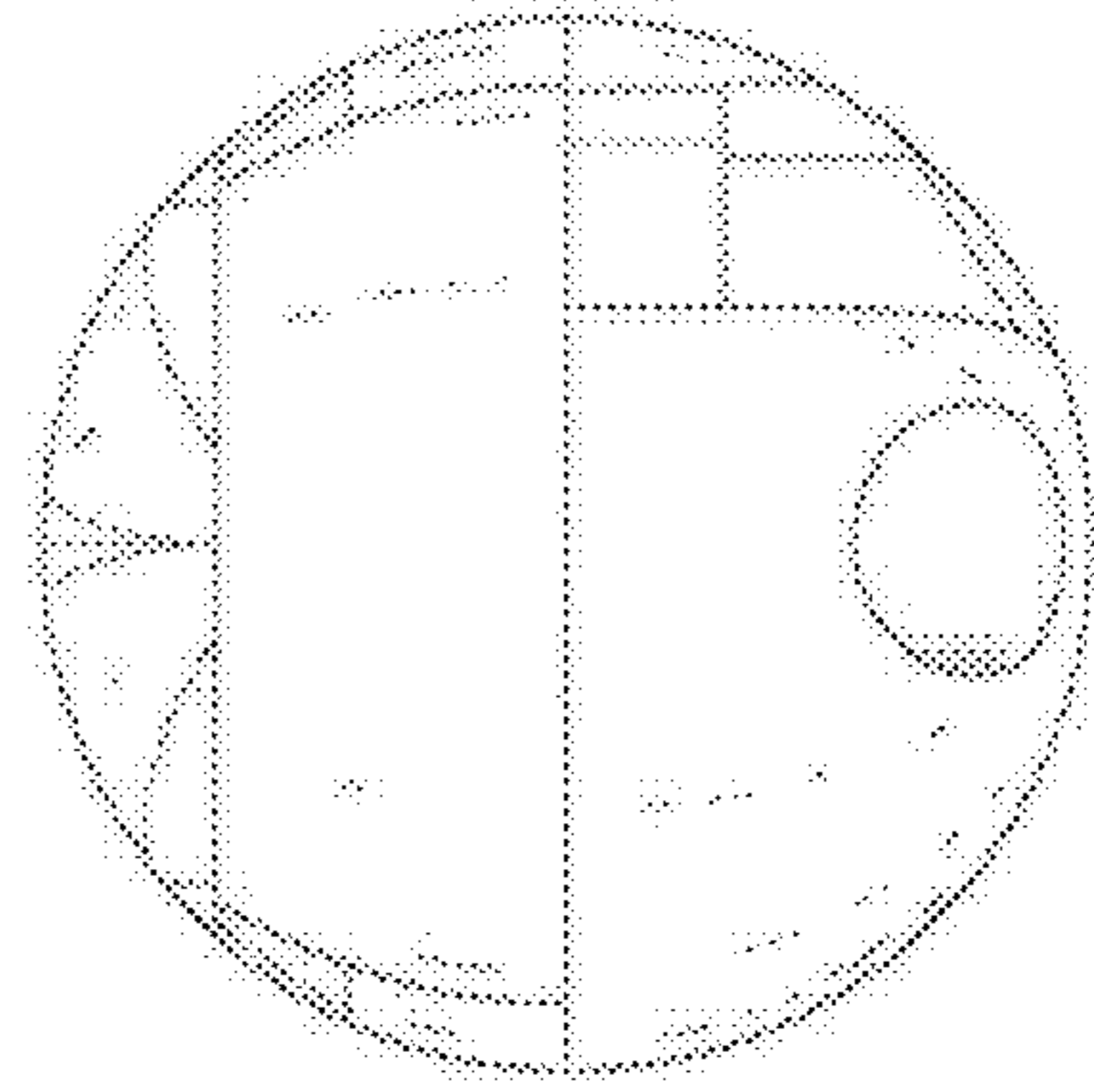

Fig. 9

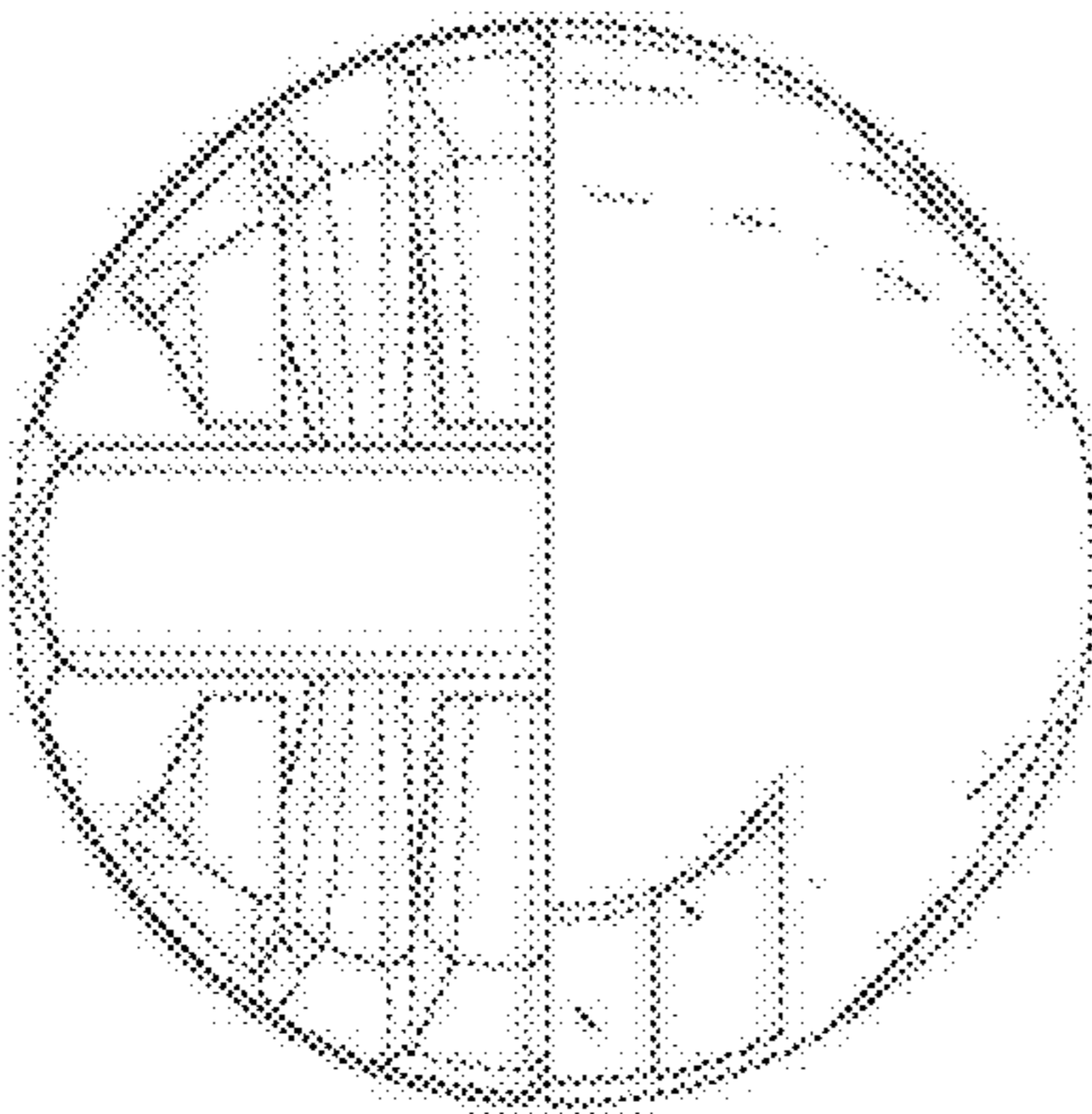

Fig. 5

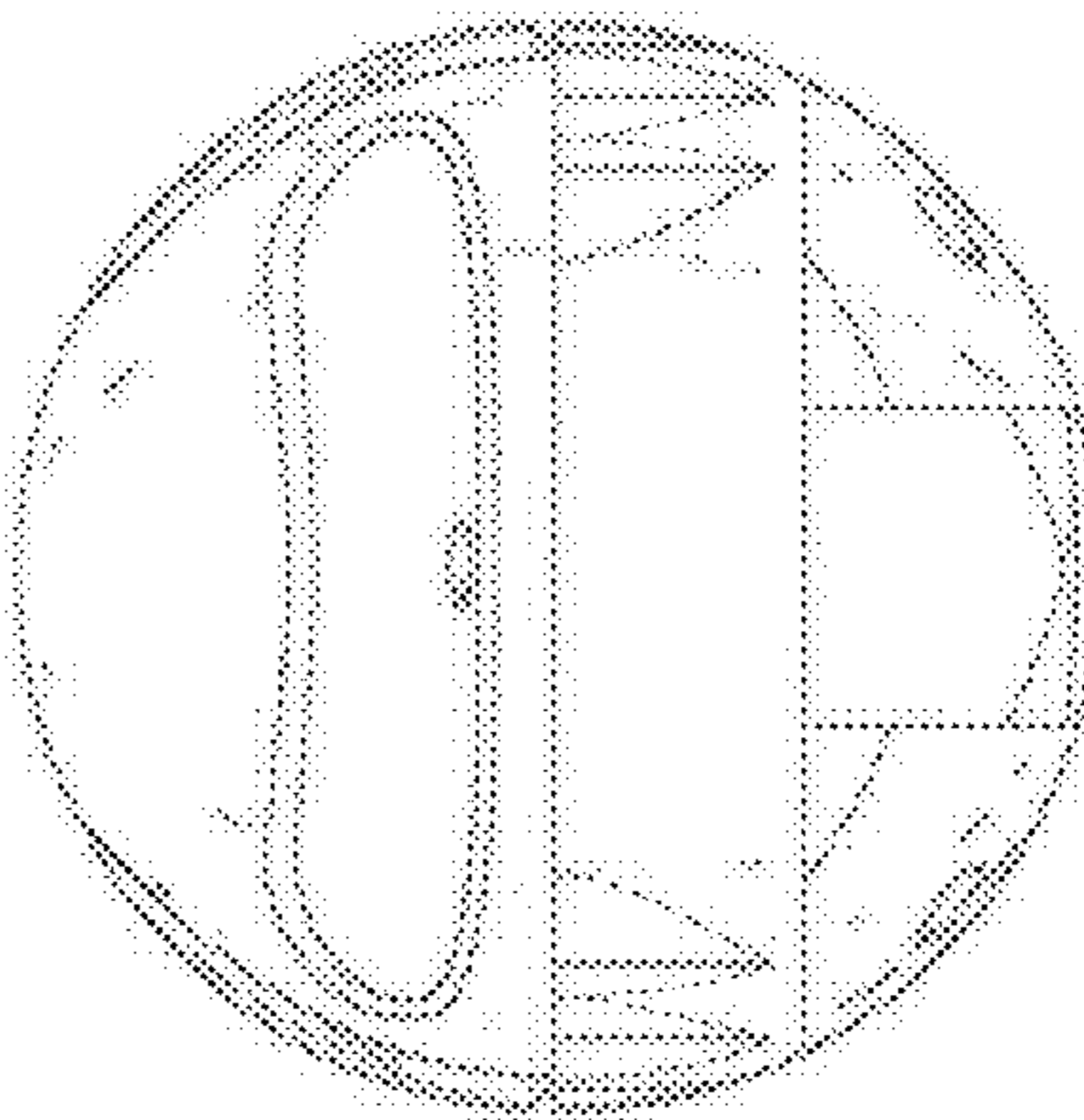

Fig. 8

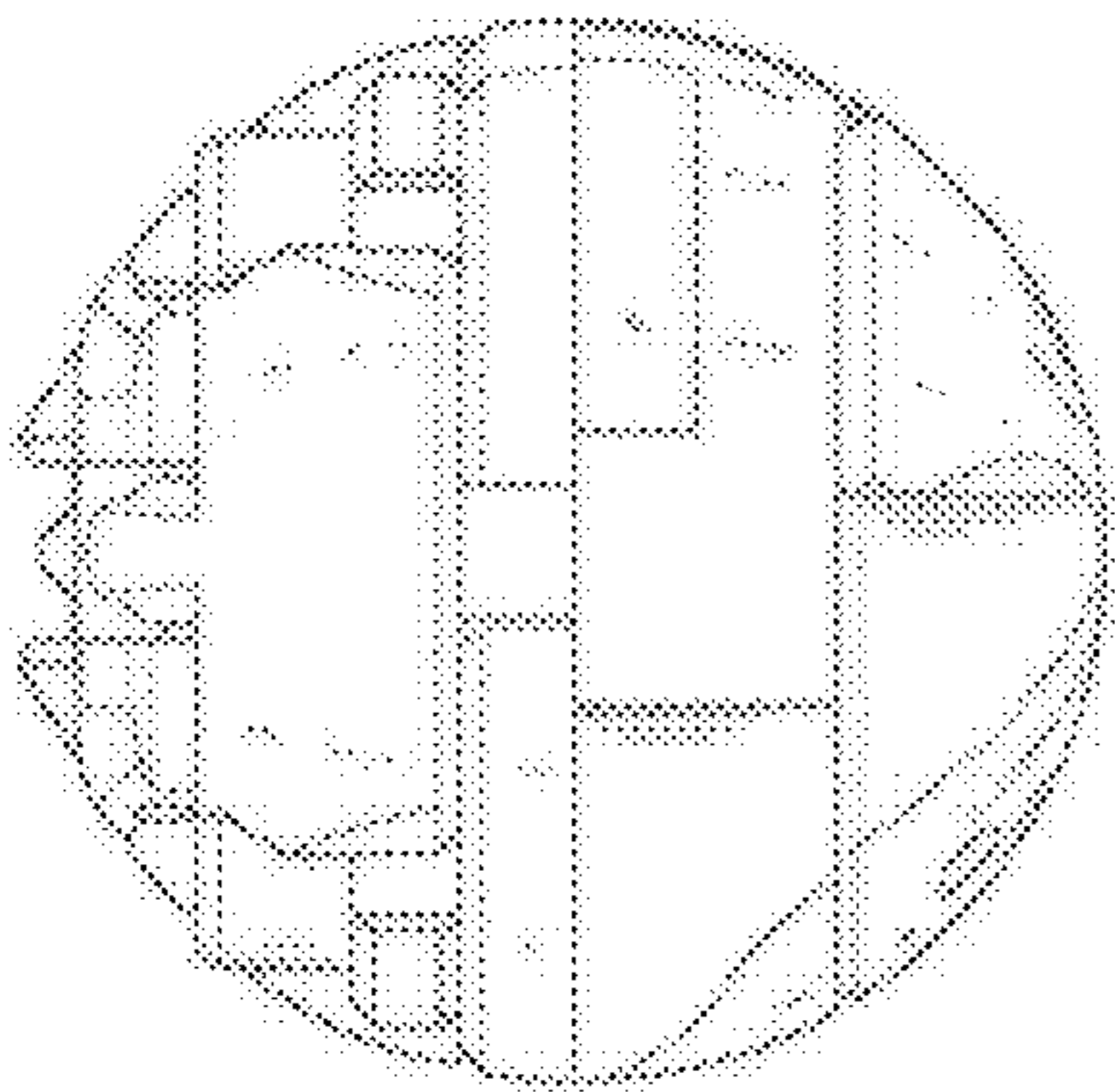

Fig. 4

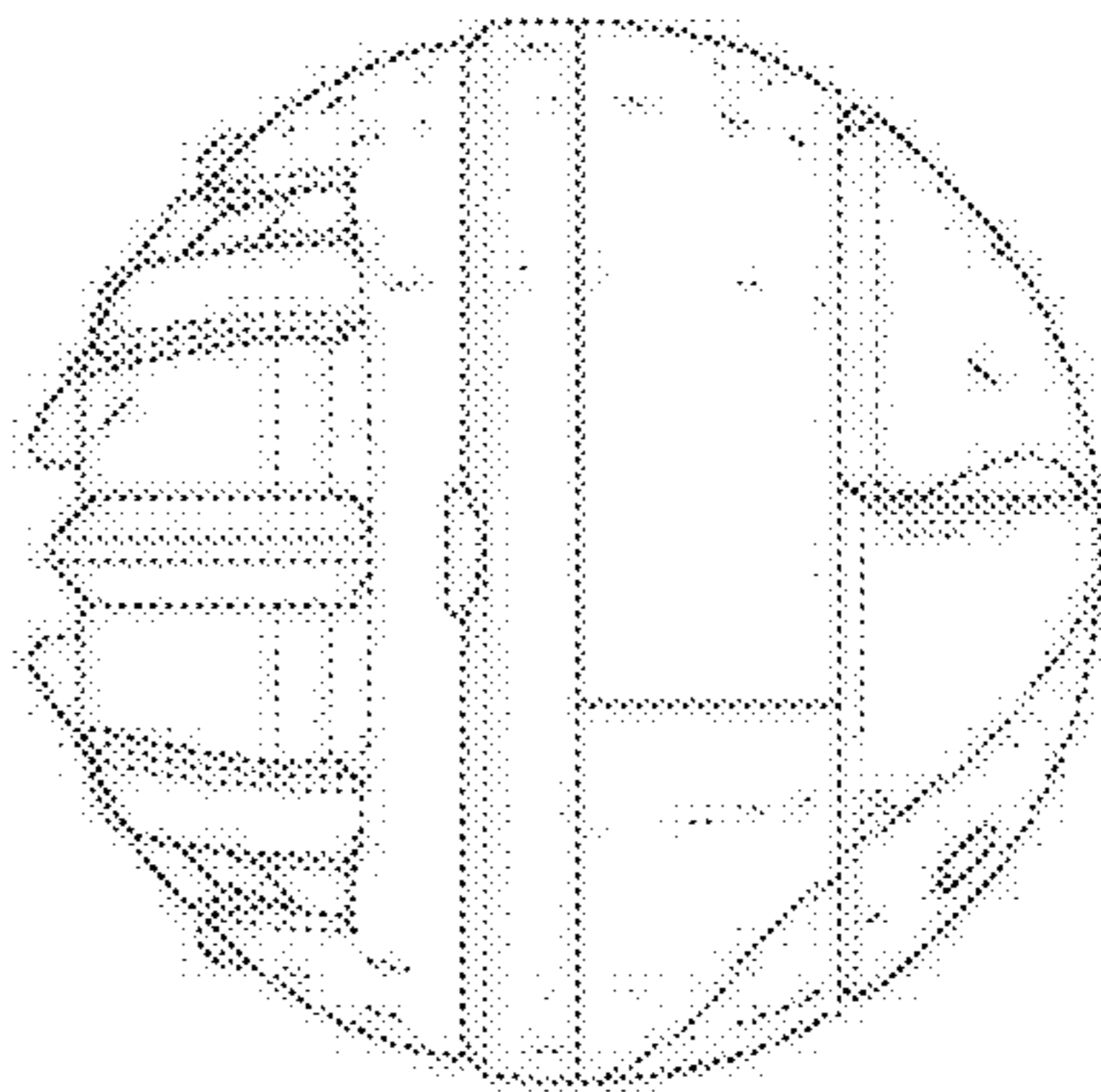

Fig. 7

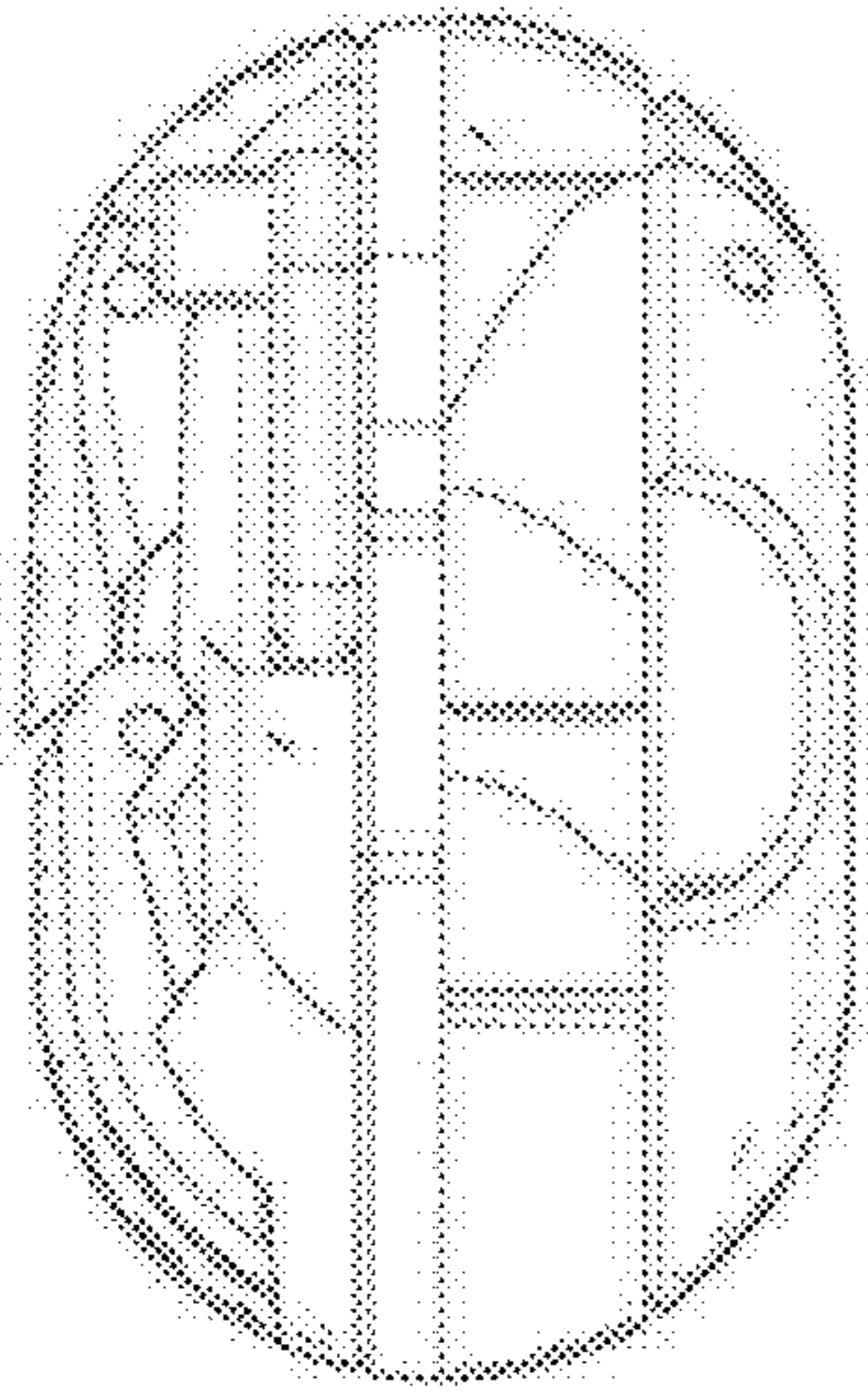

Fig. 10

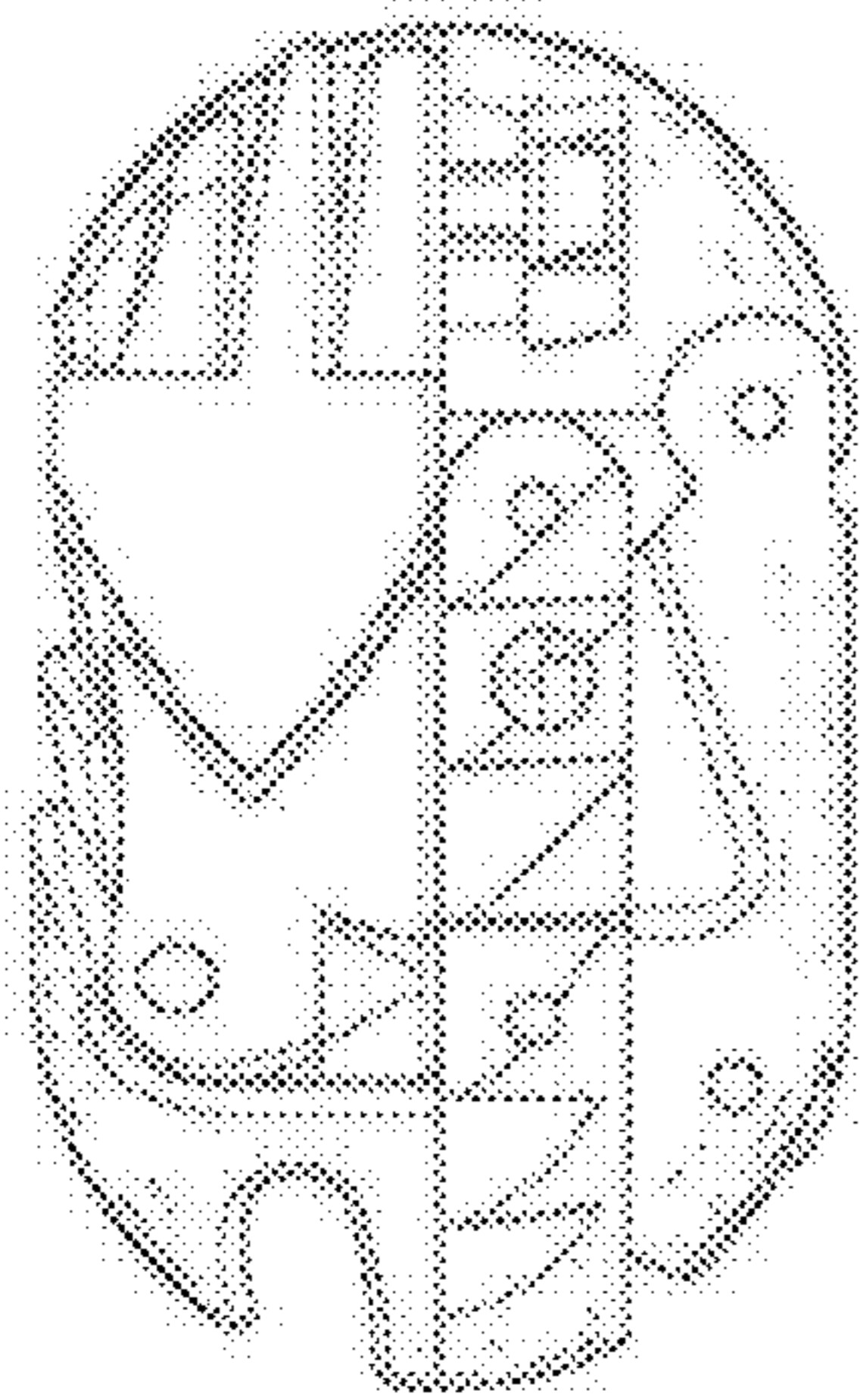

Fig. 11

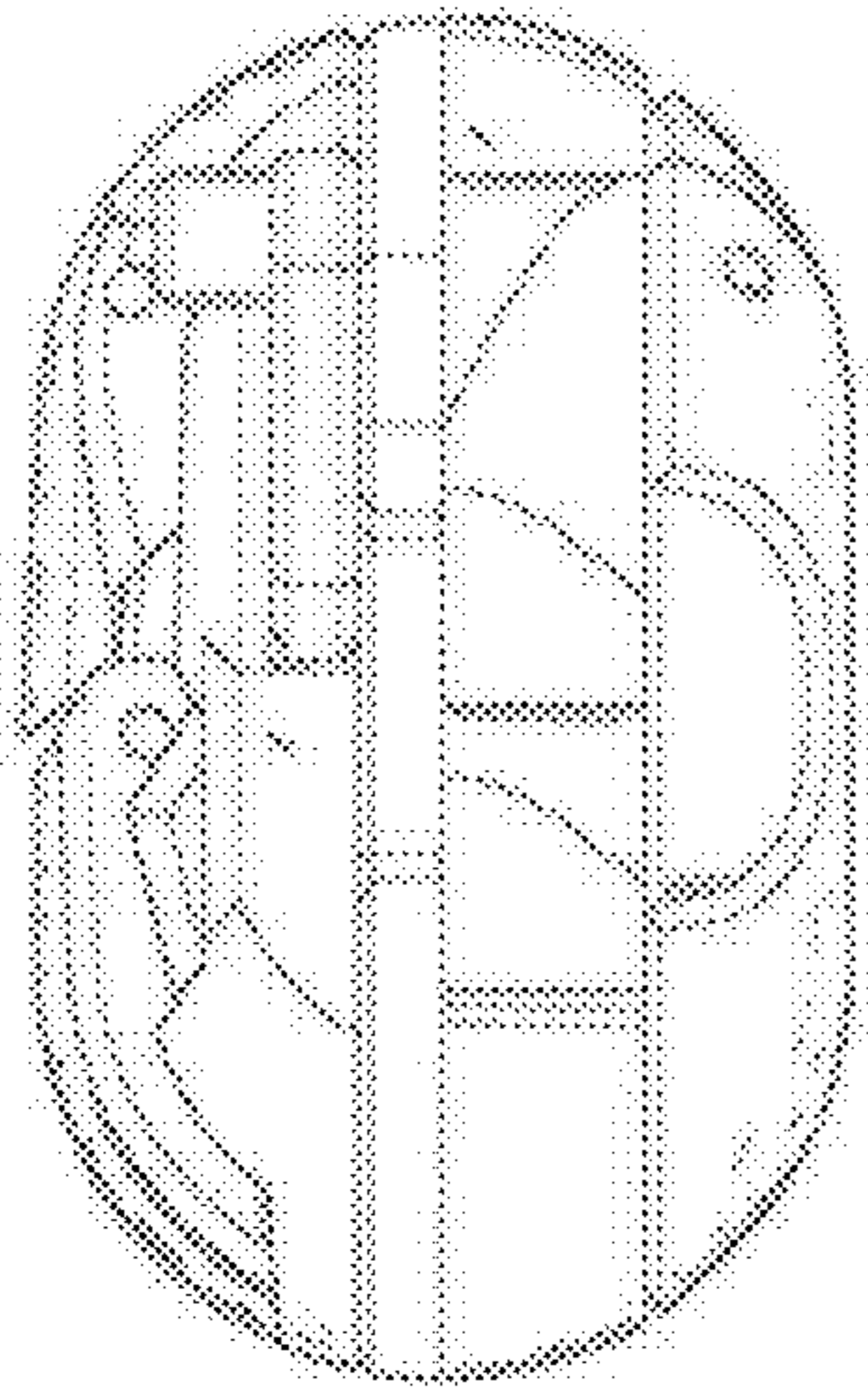

Fig. 12

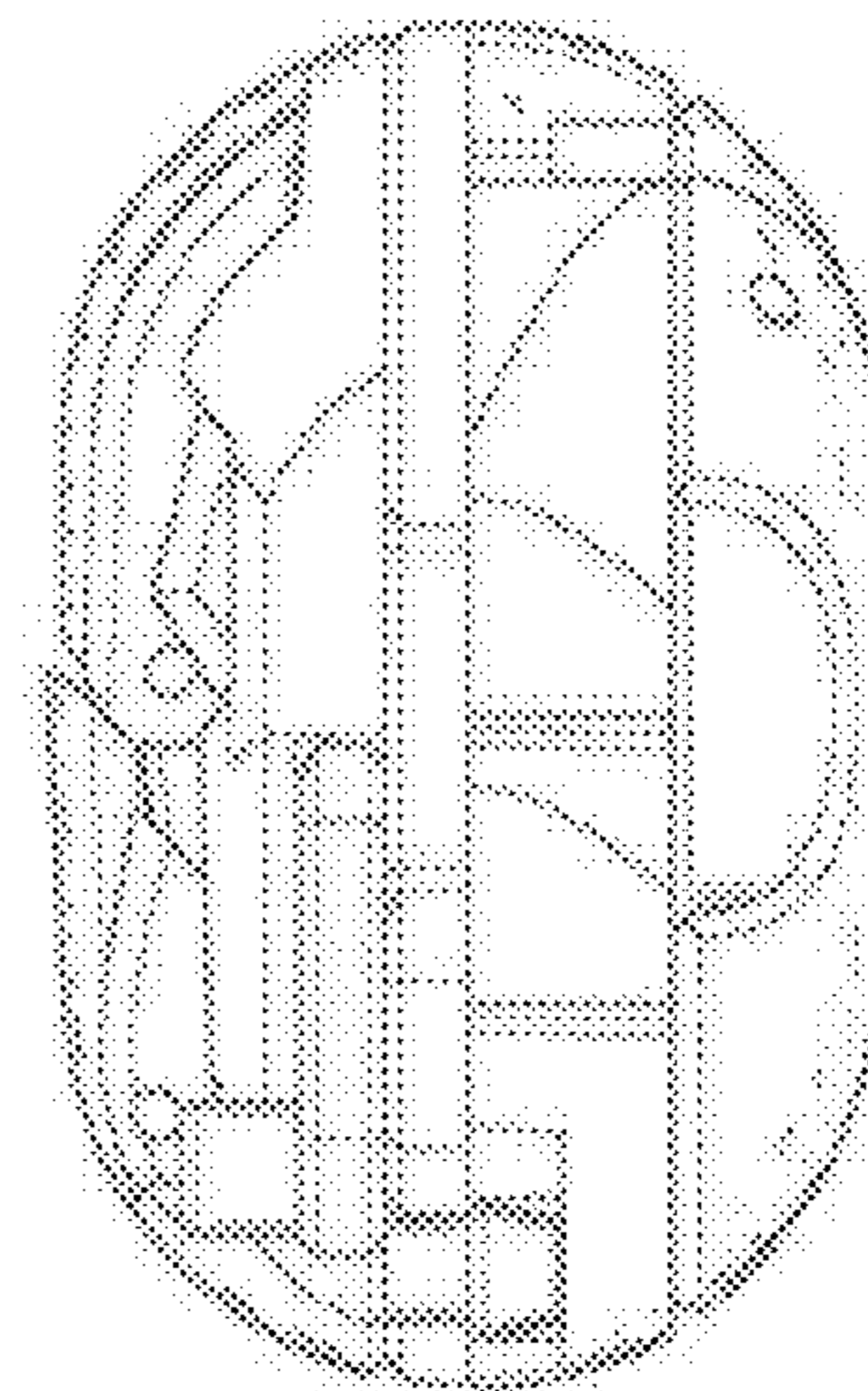

Fig. 13

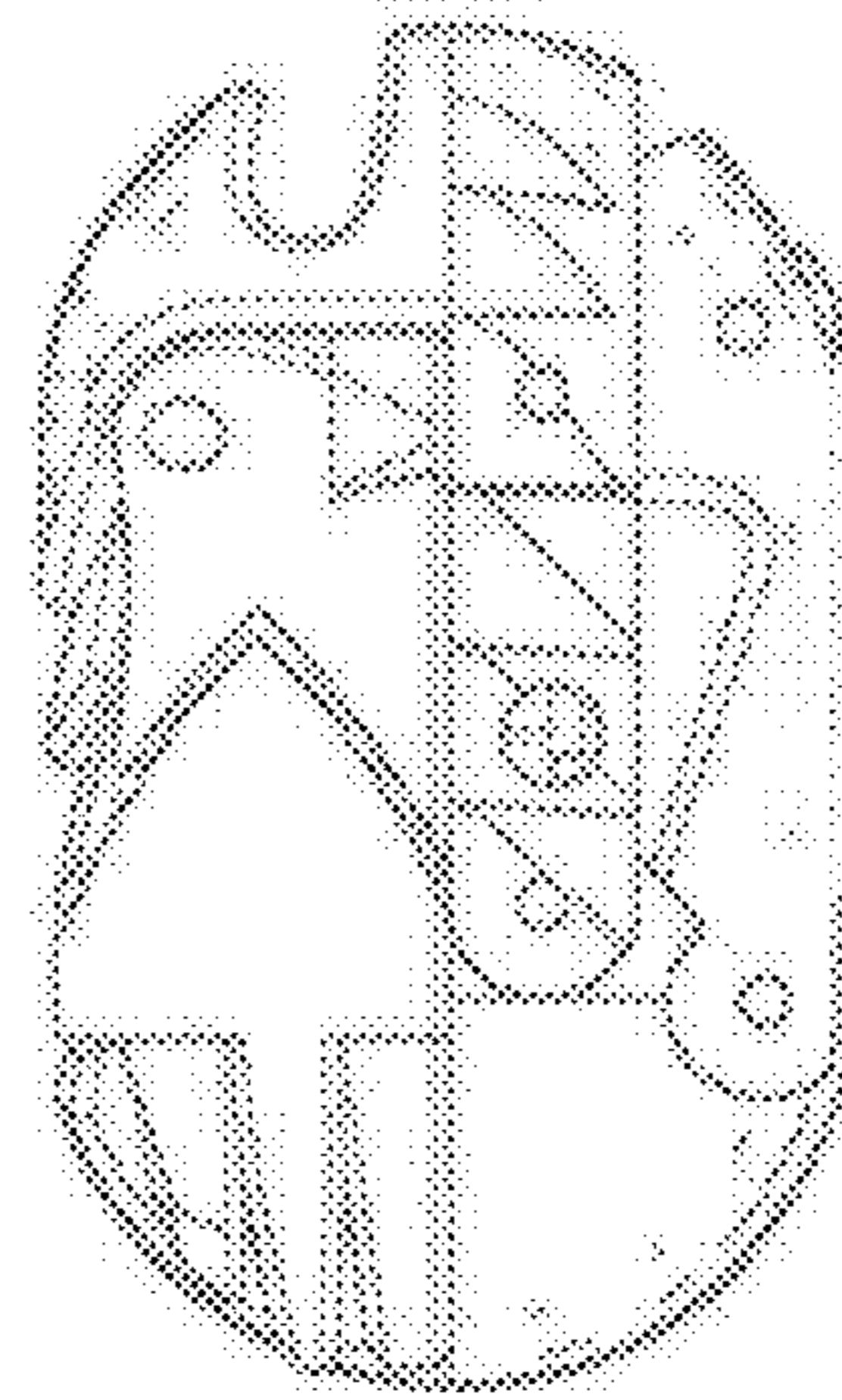

Fig. 14

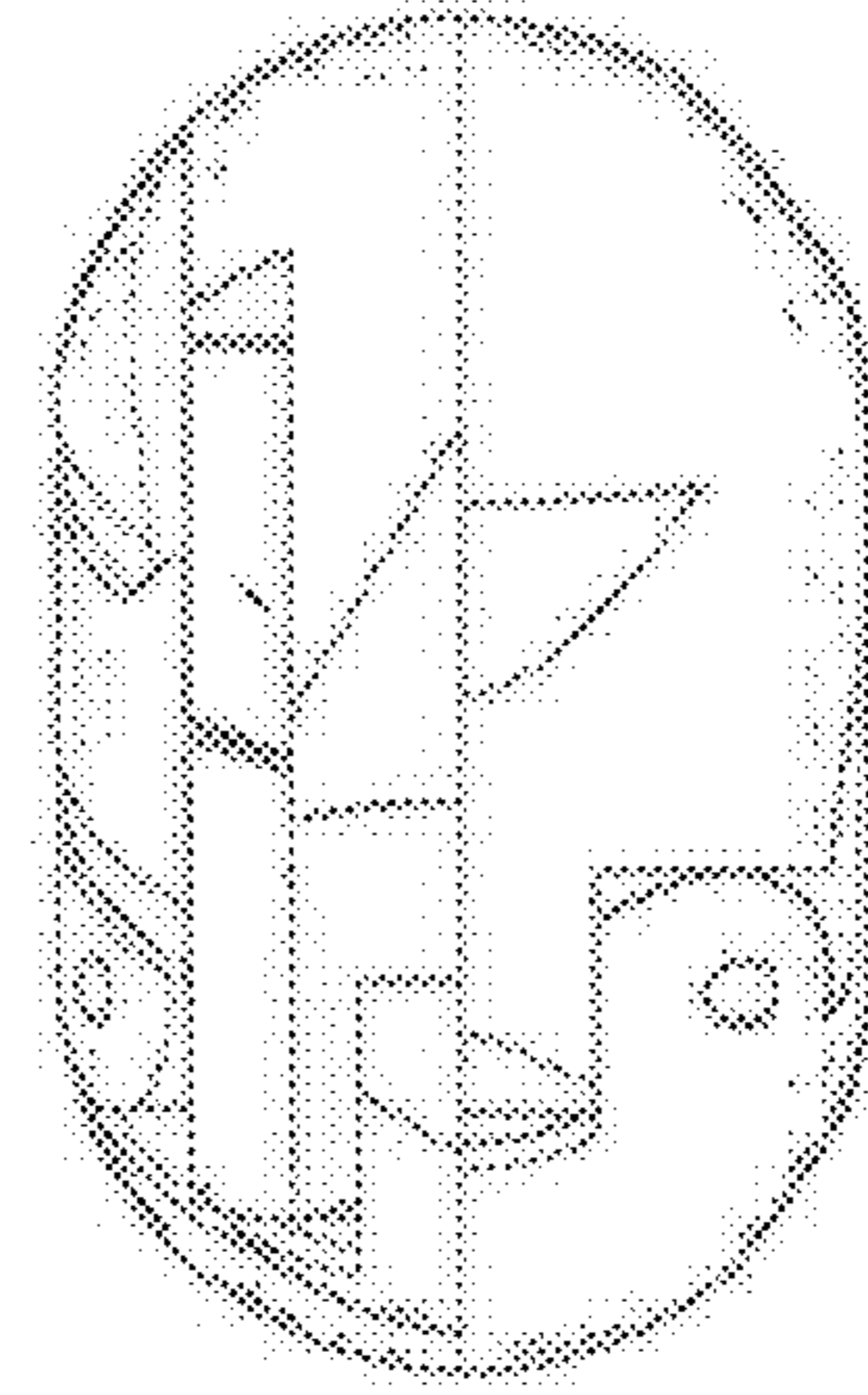

Fig. 15

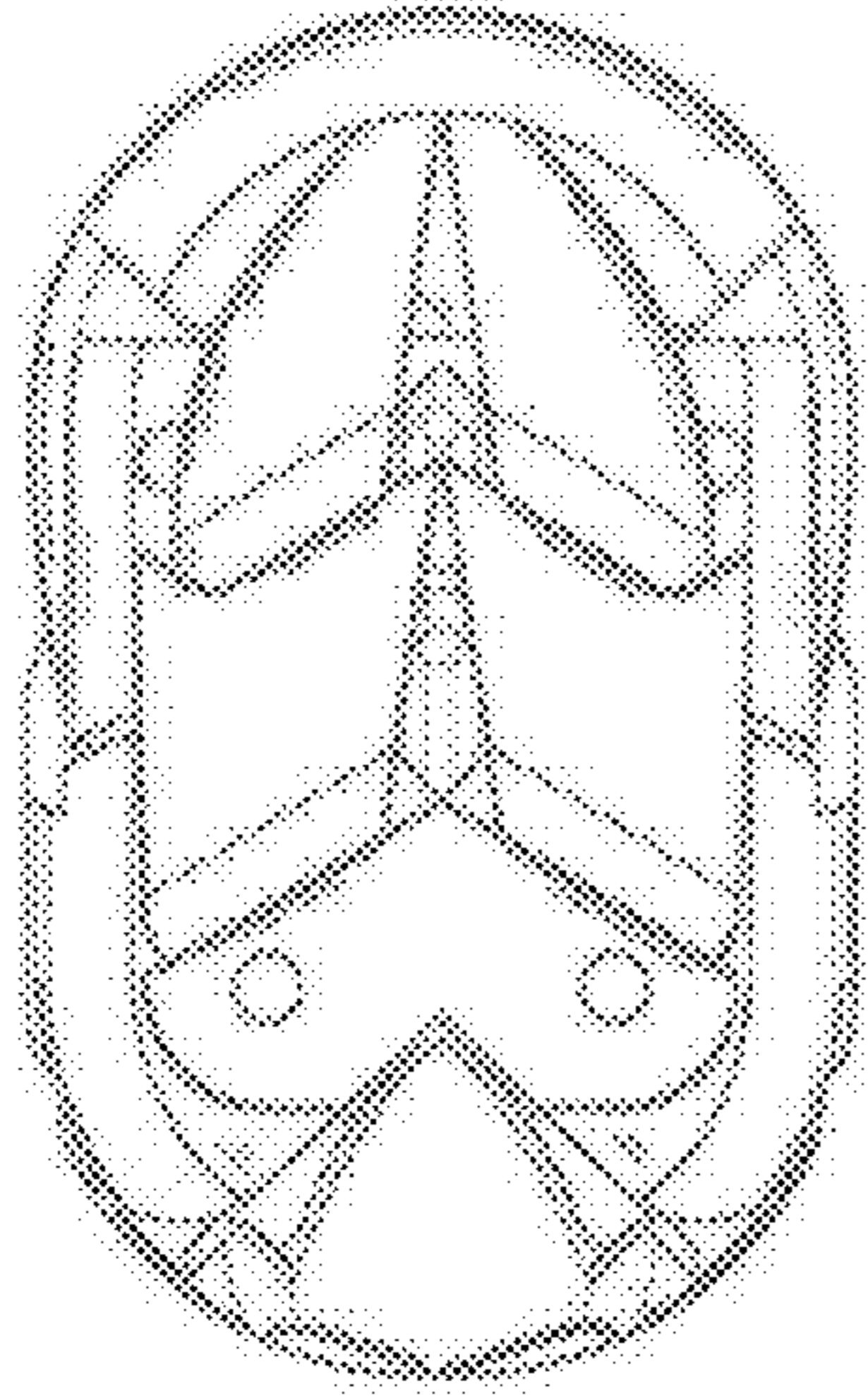

Fig. 16

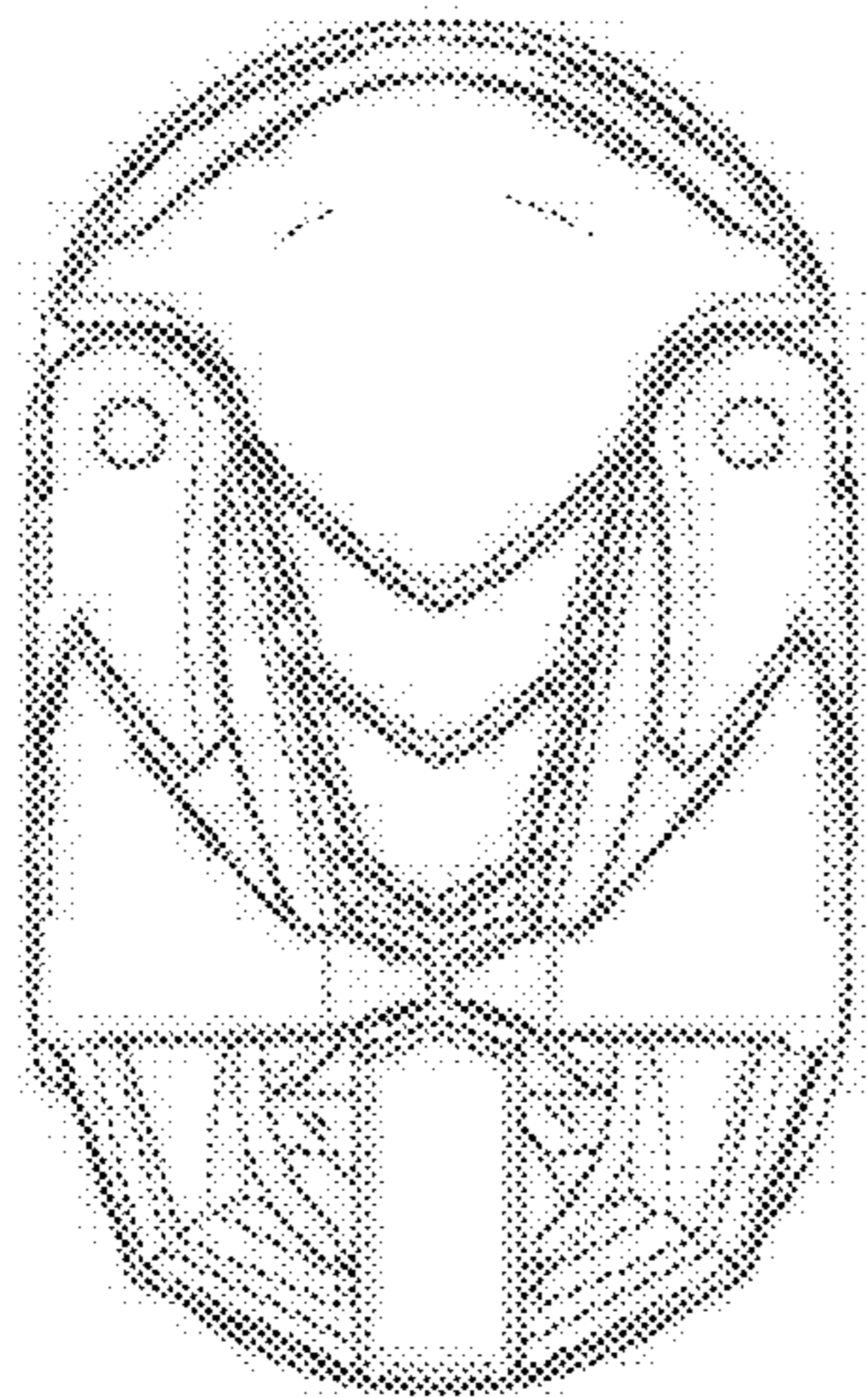

Fig. 17

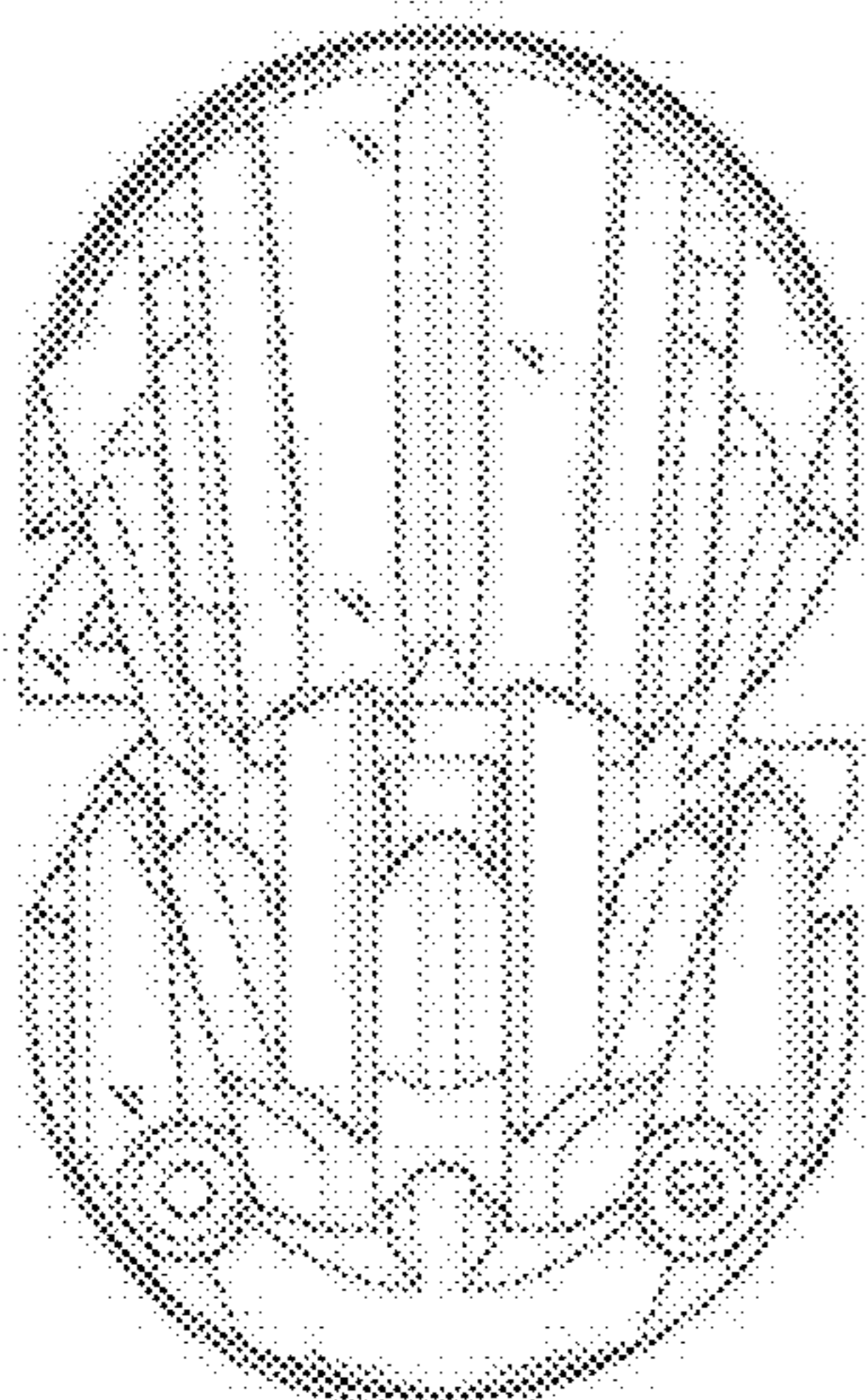

Fig. 18

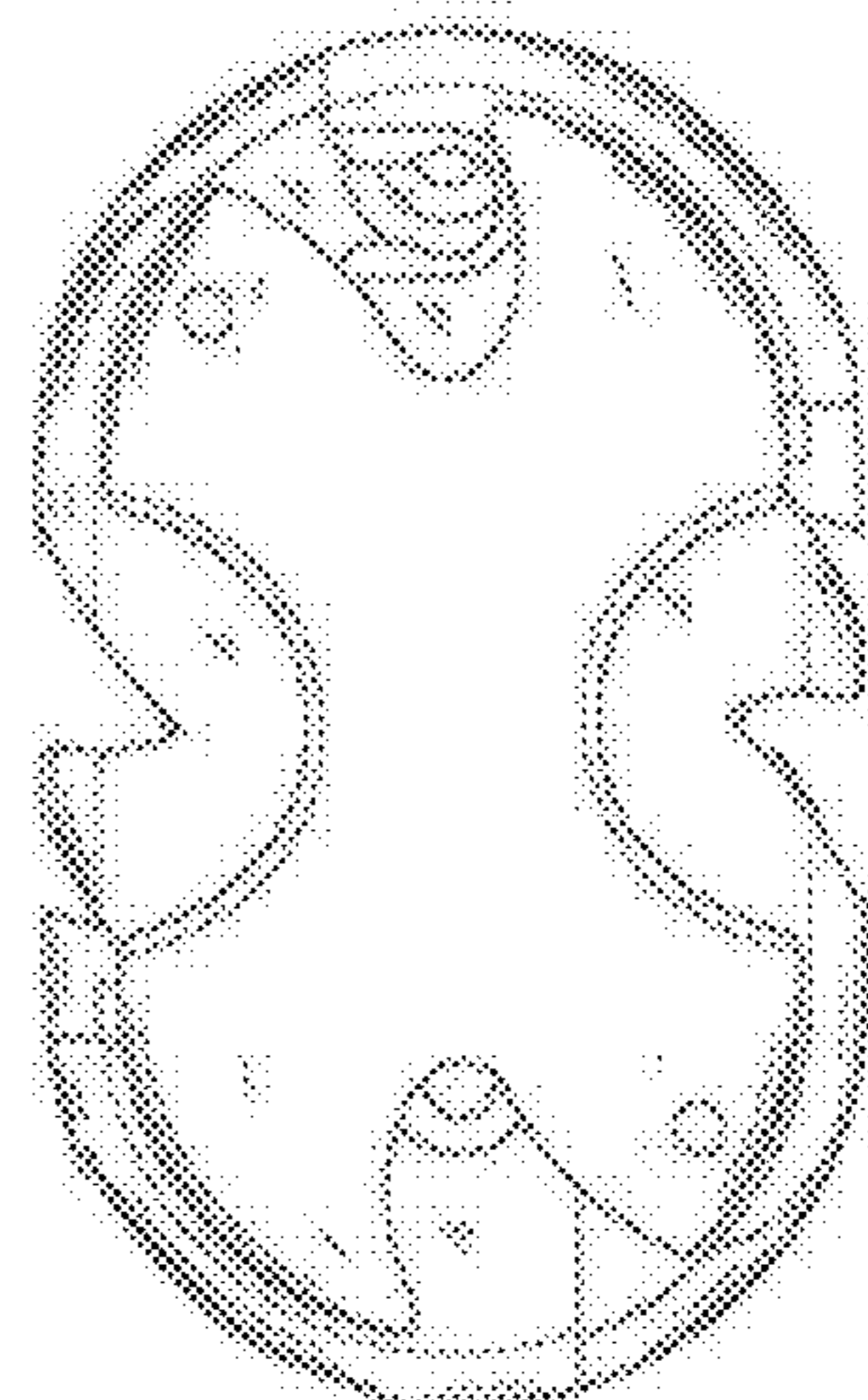

Fig. 19

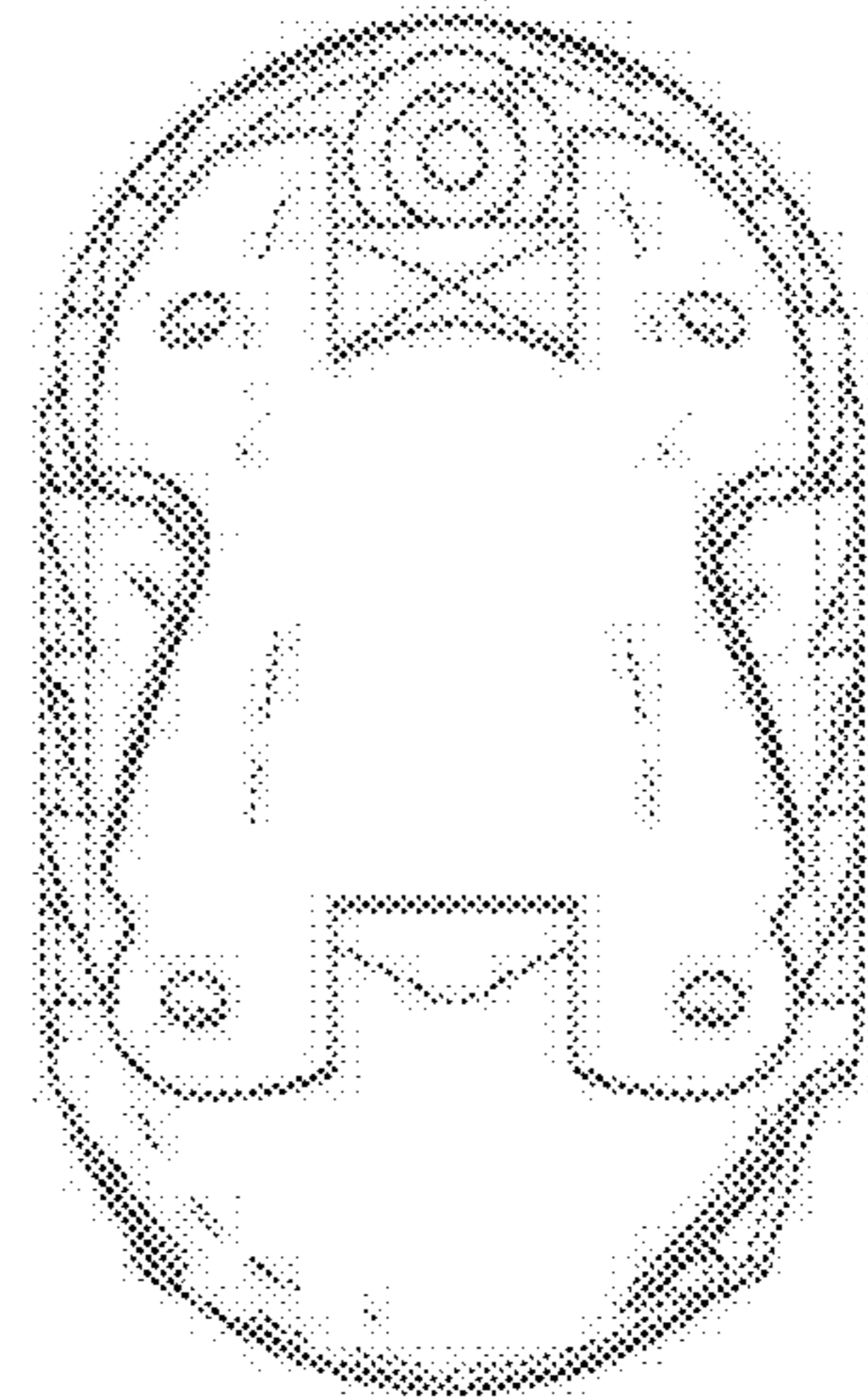

Fig. 20

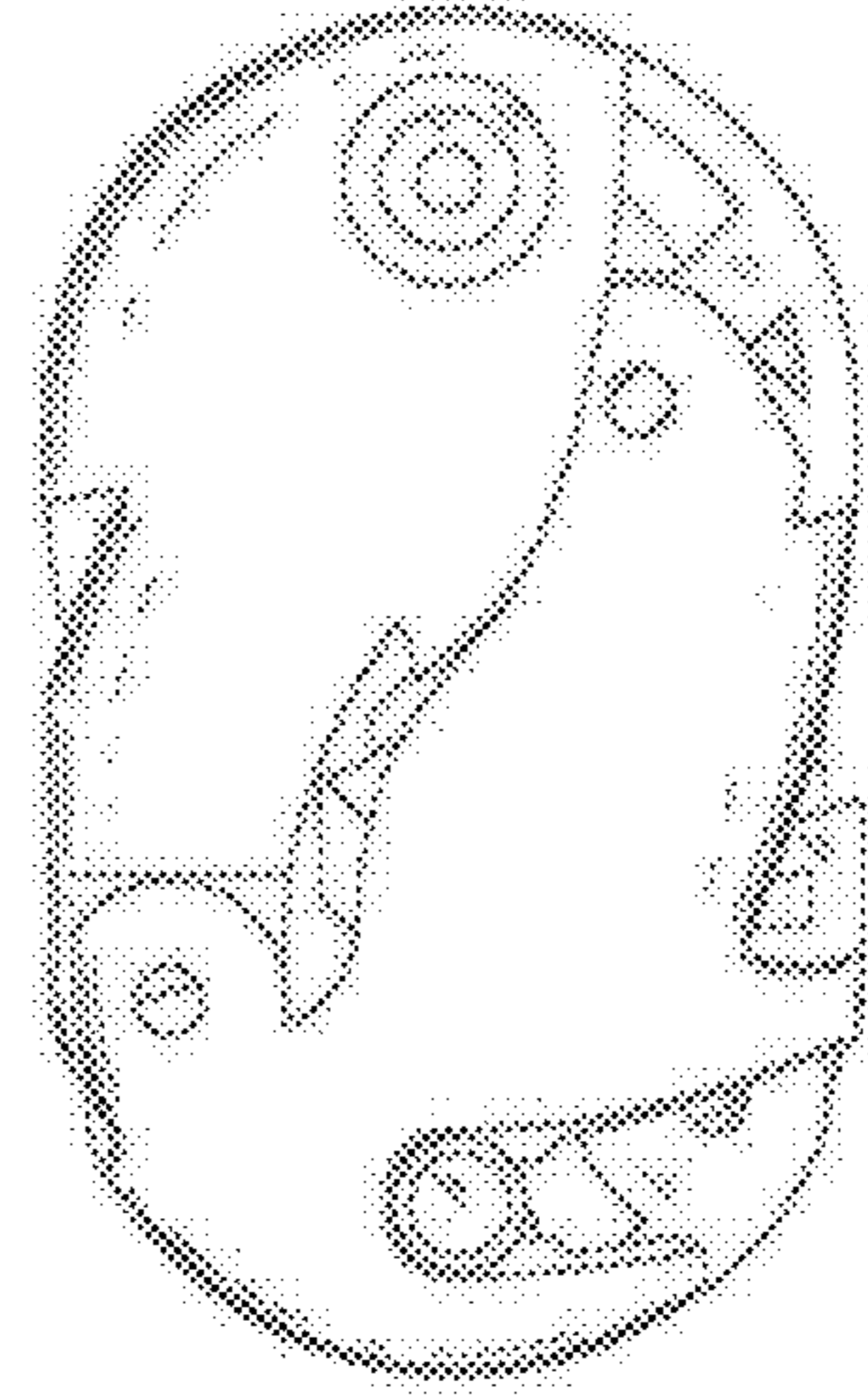

Fig. 21

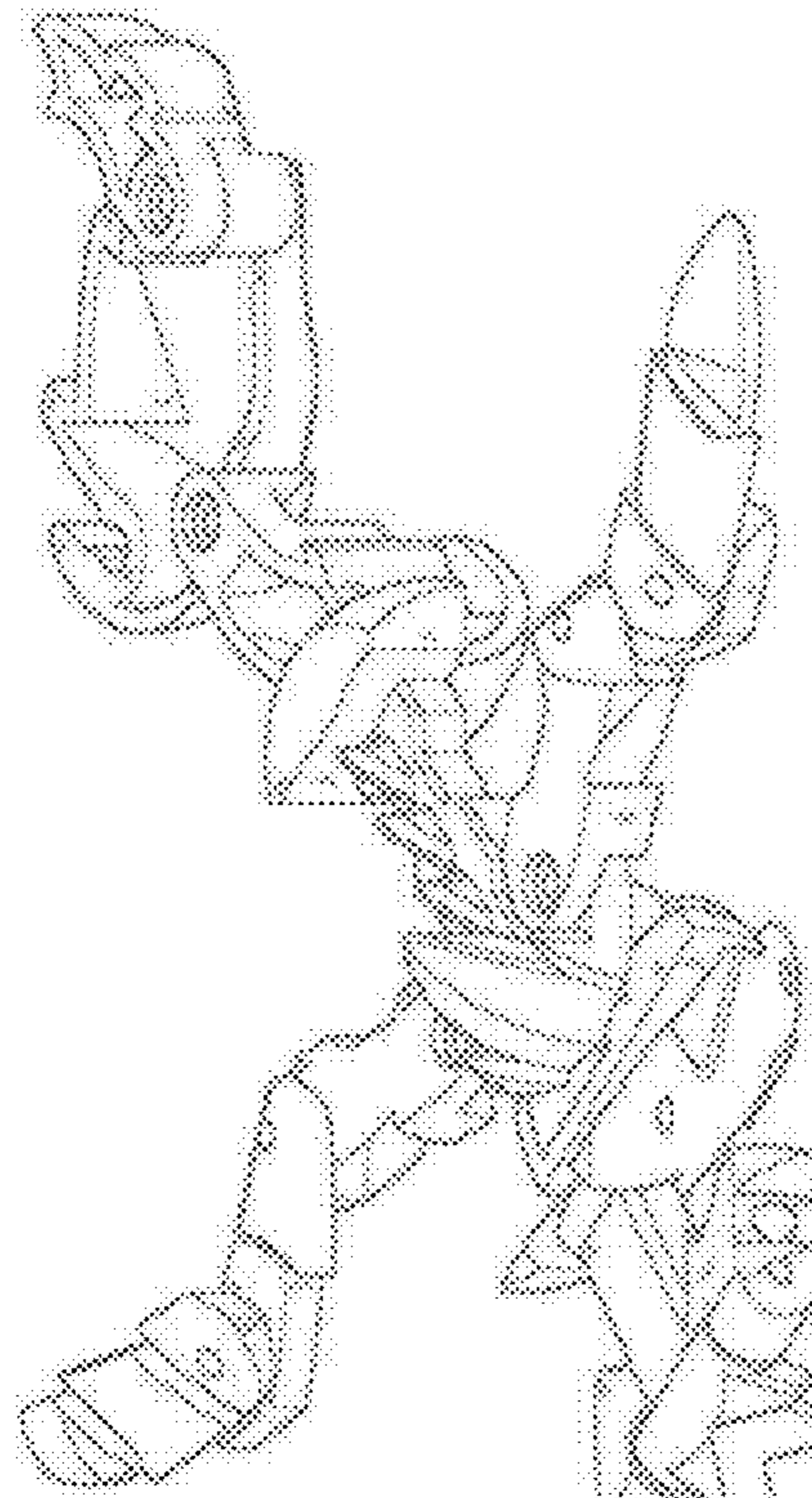

FIG. 24

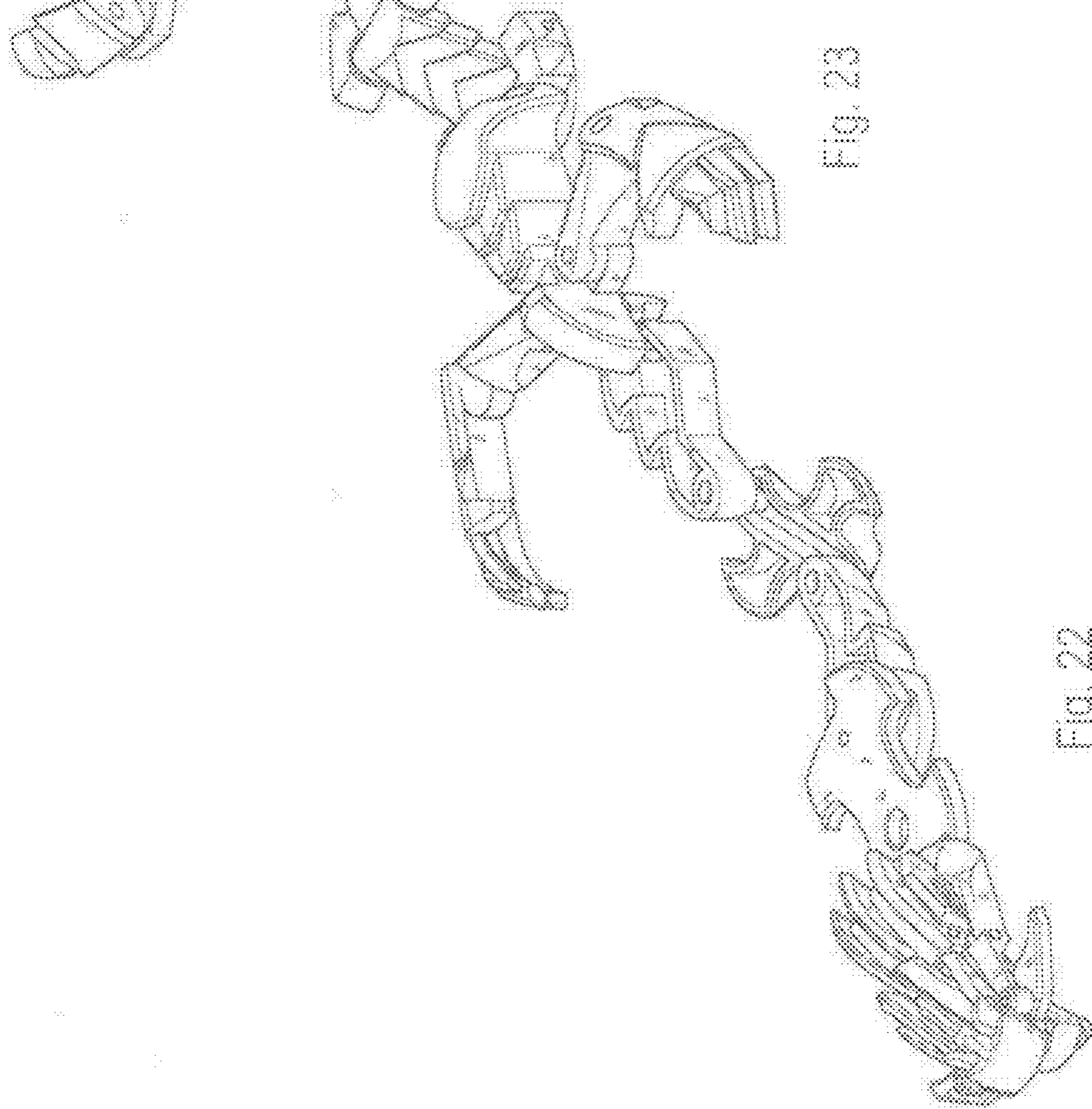

FIG. 23

FIG. 22

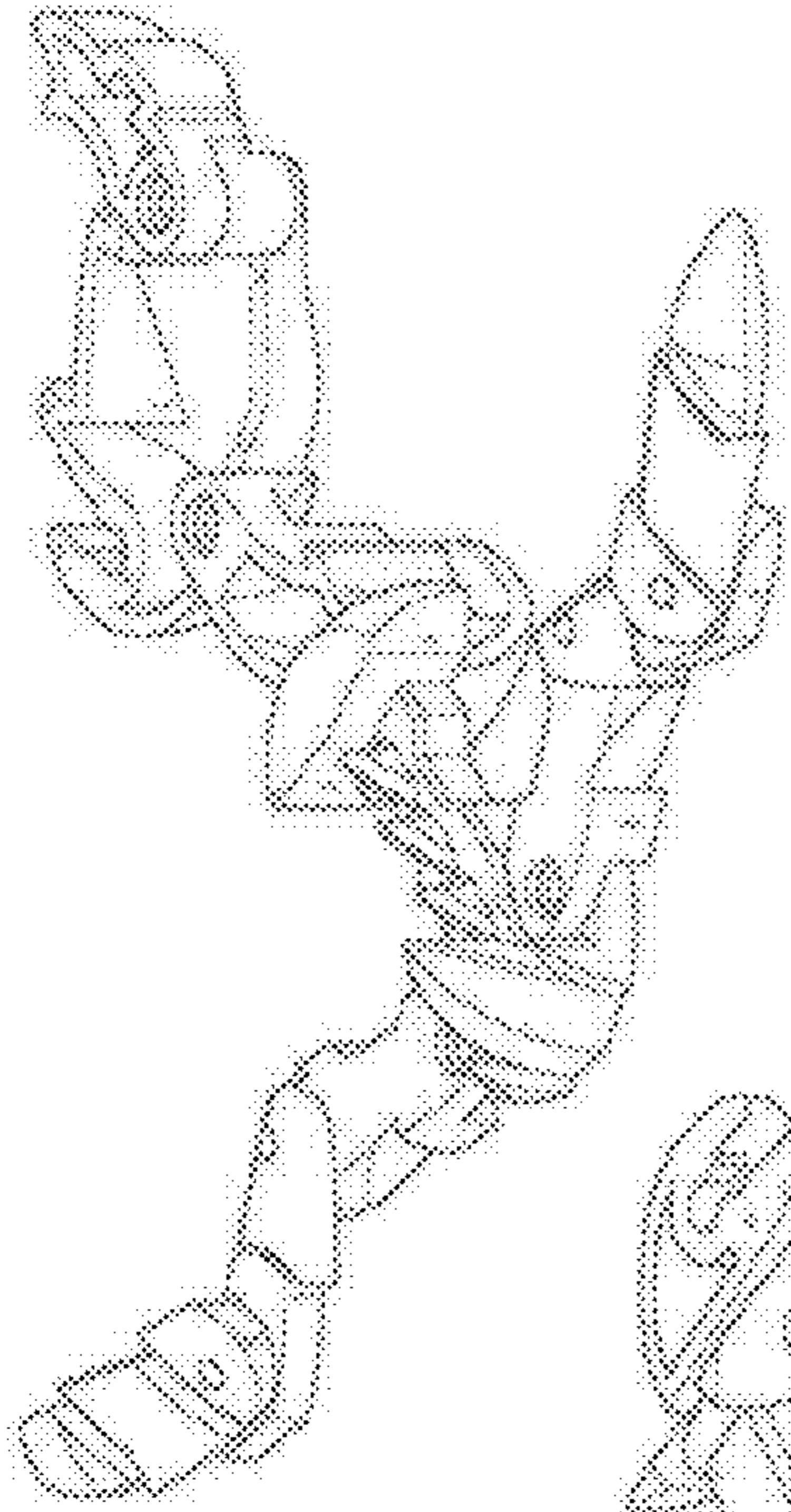

Fig. 27

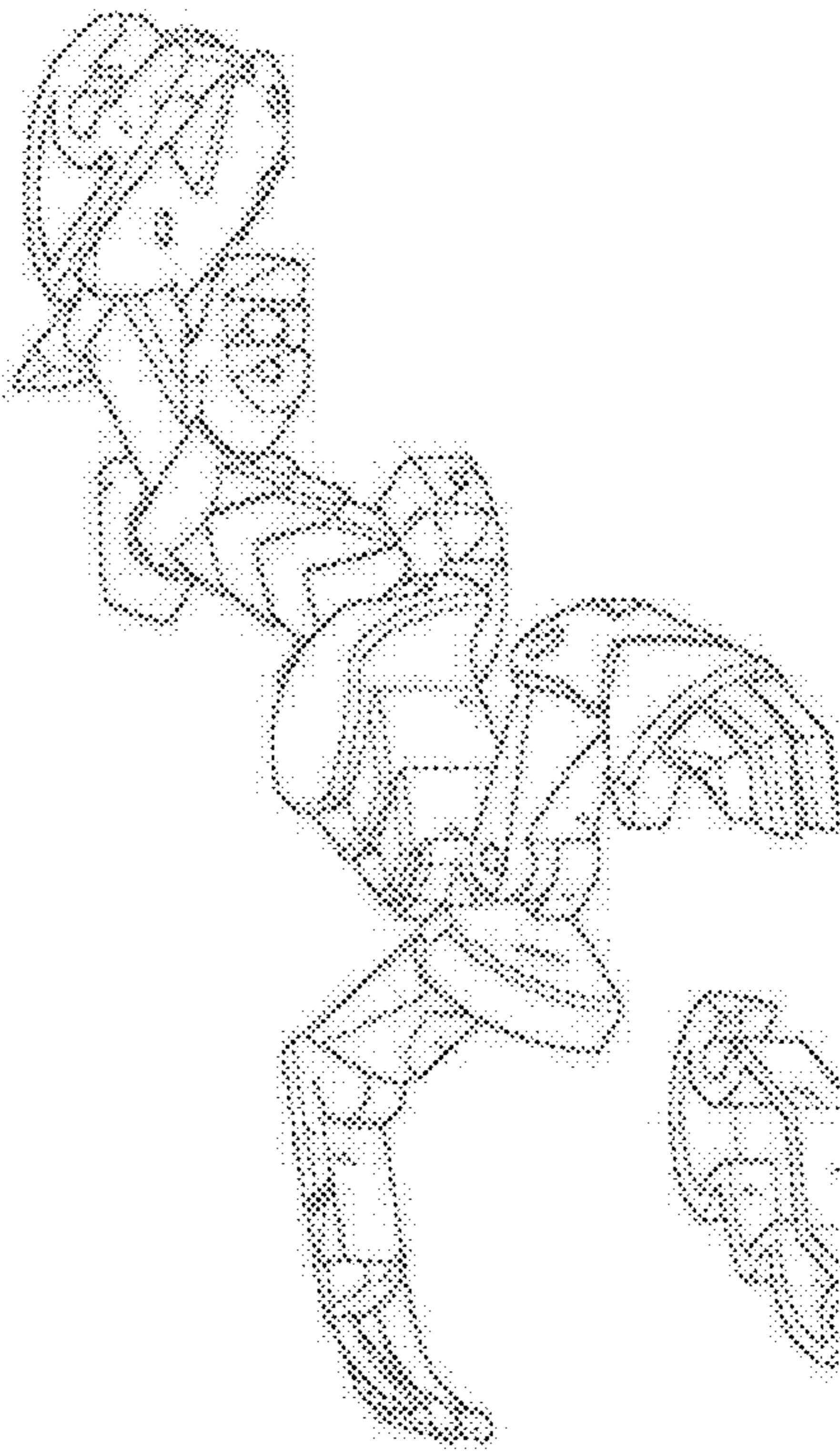

Fig. 26

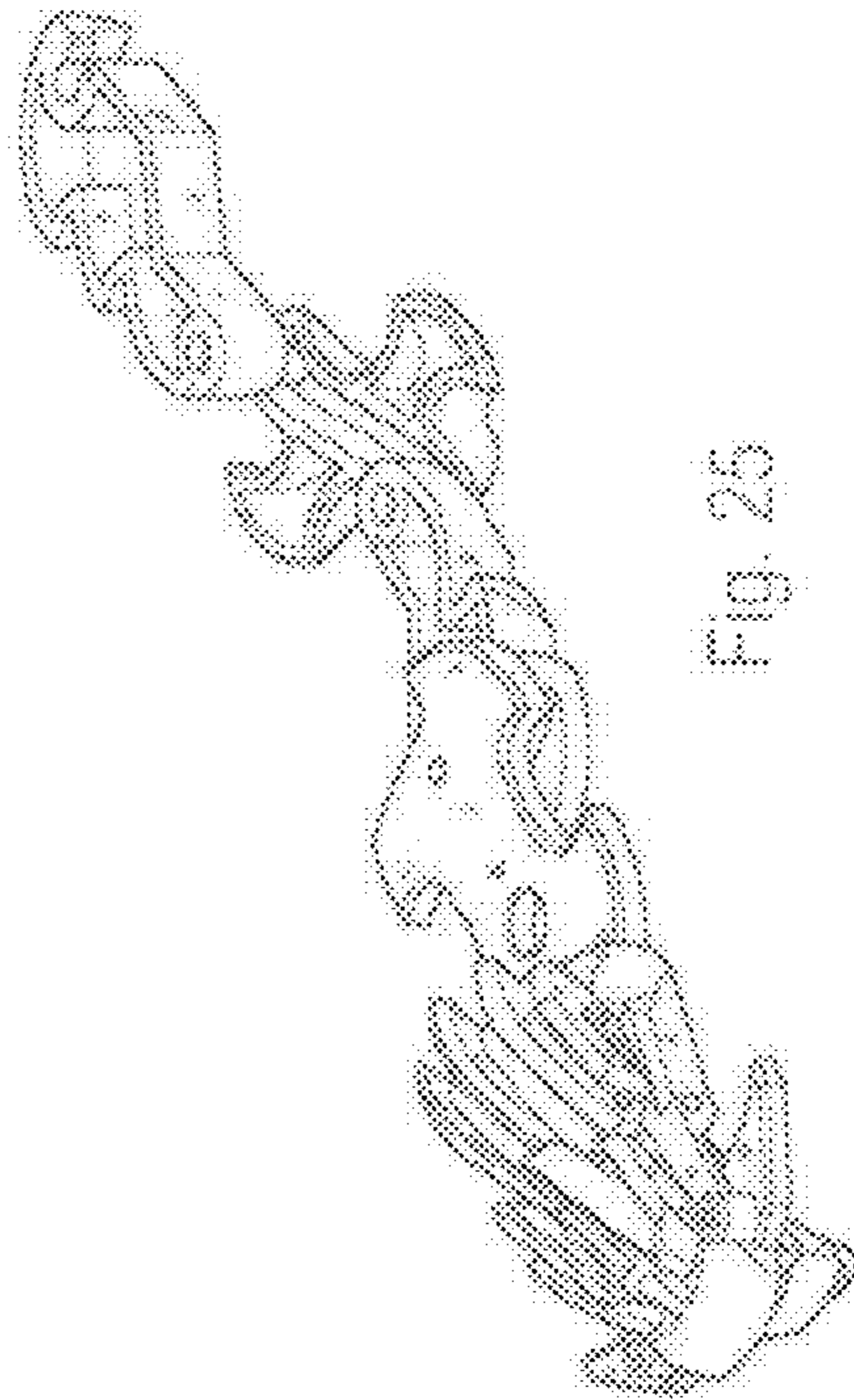

Fig. 25

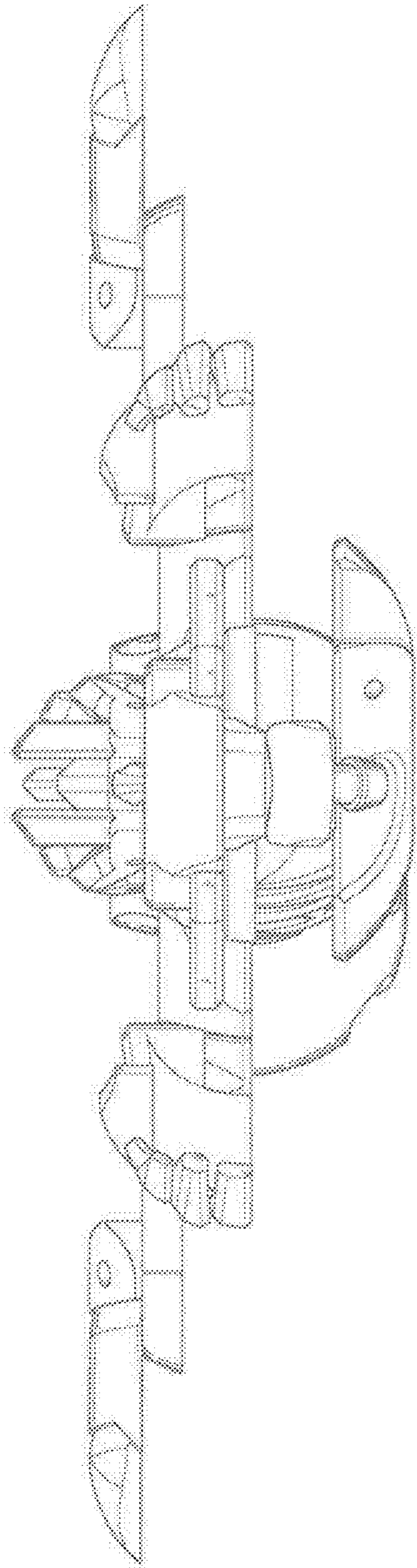

Fig. 28

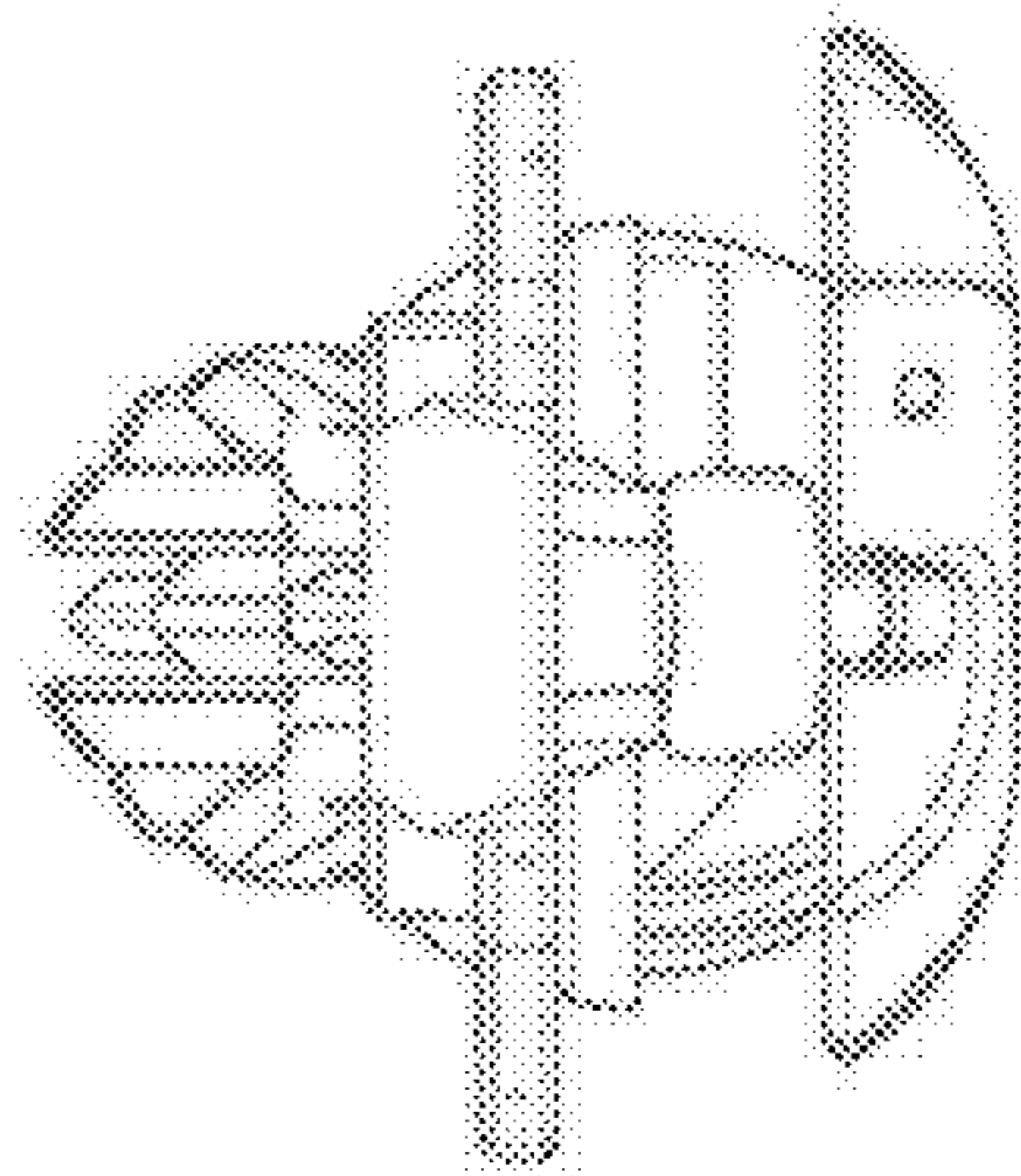

Fig. 29

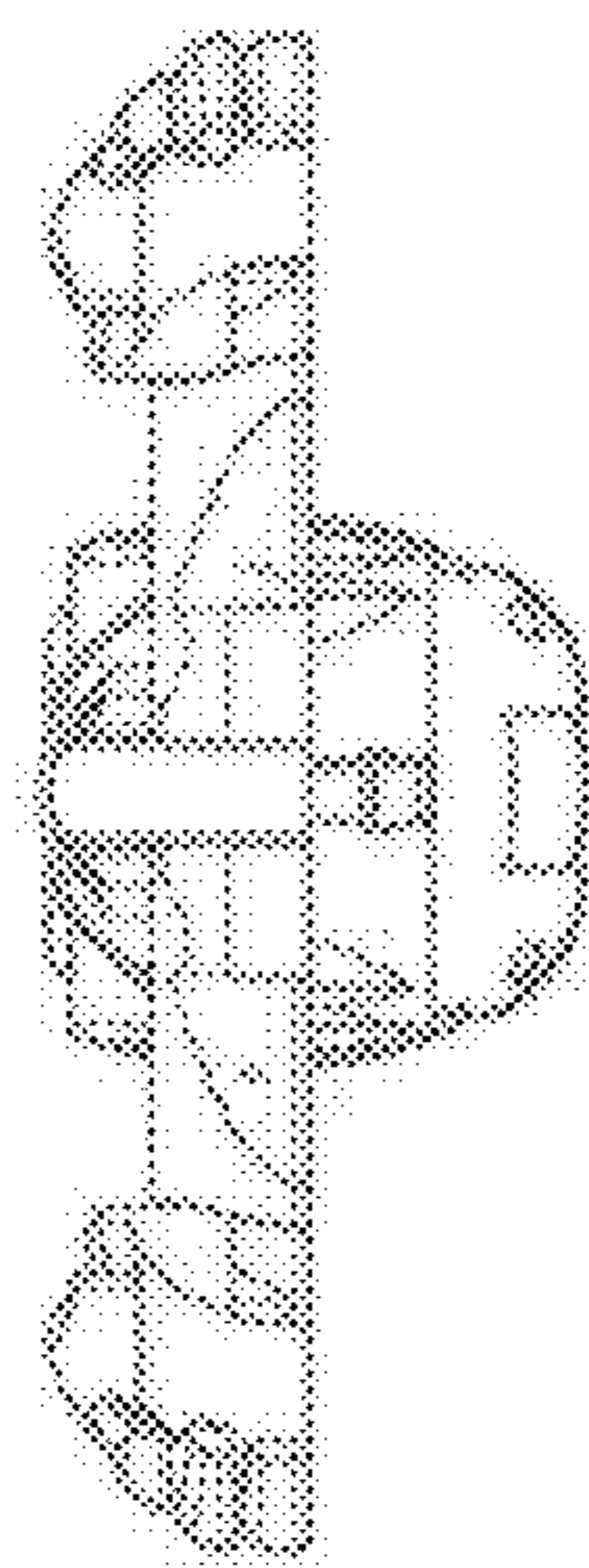

Fig. 30

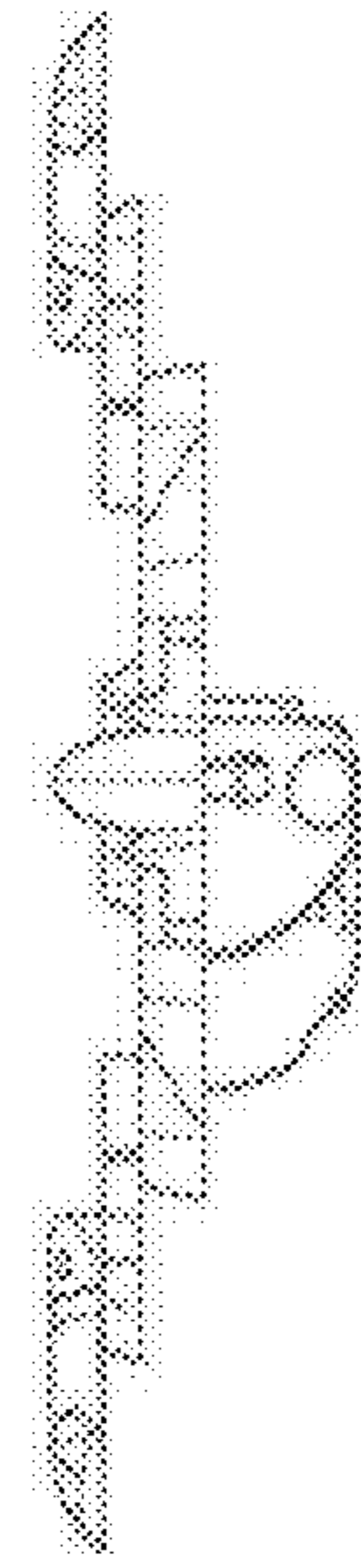

Fig. 31

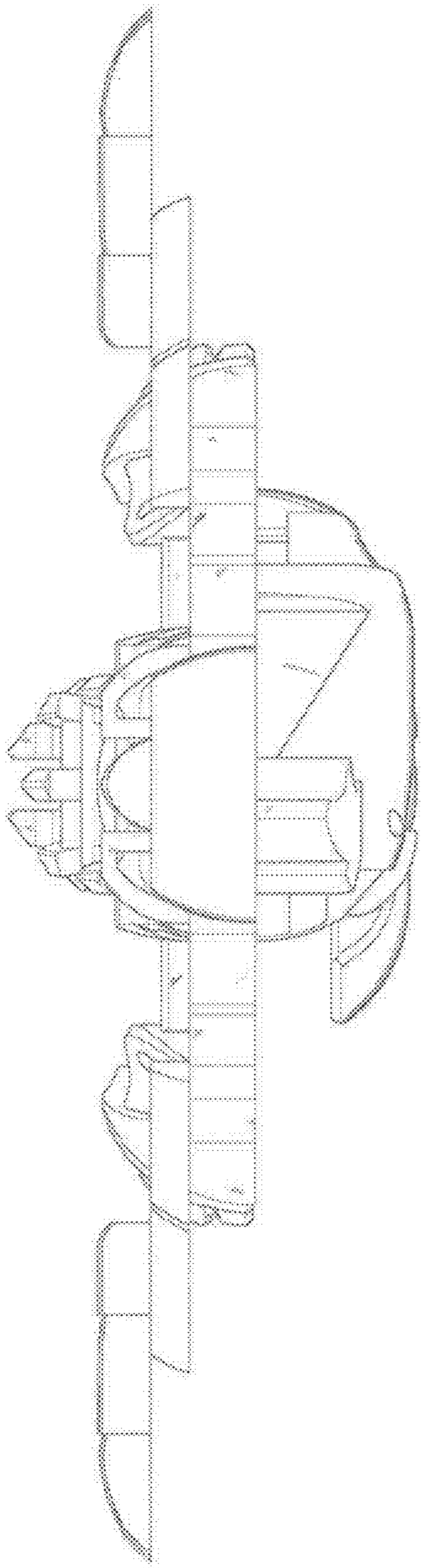

Fig. 32

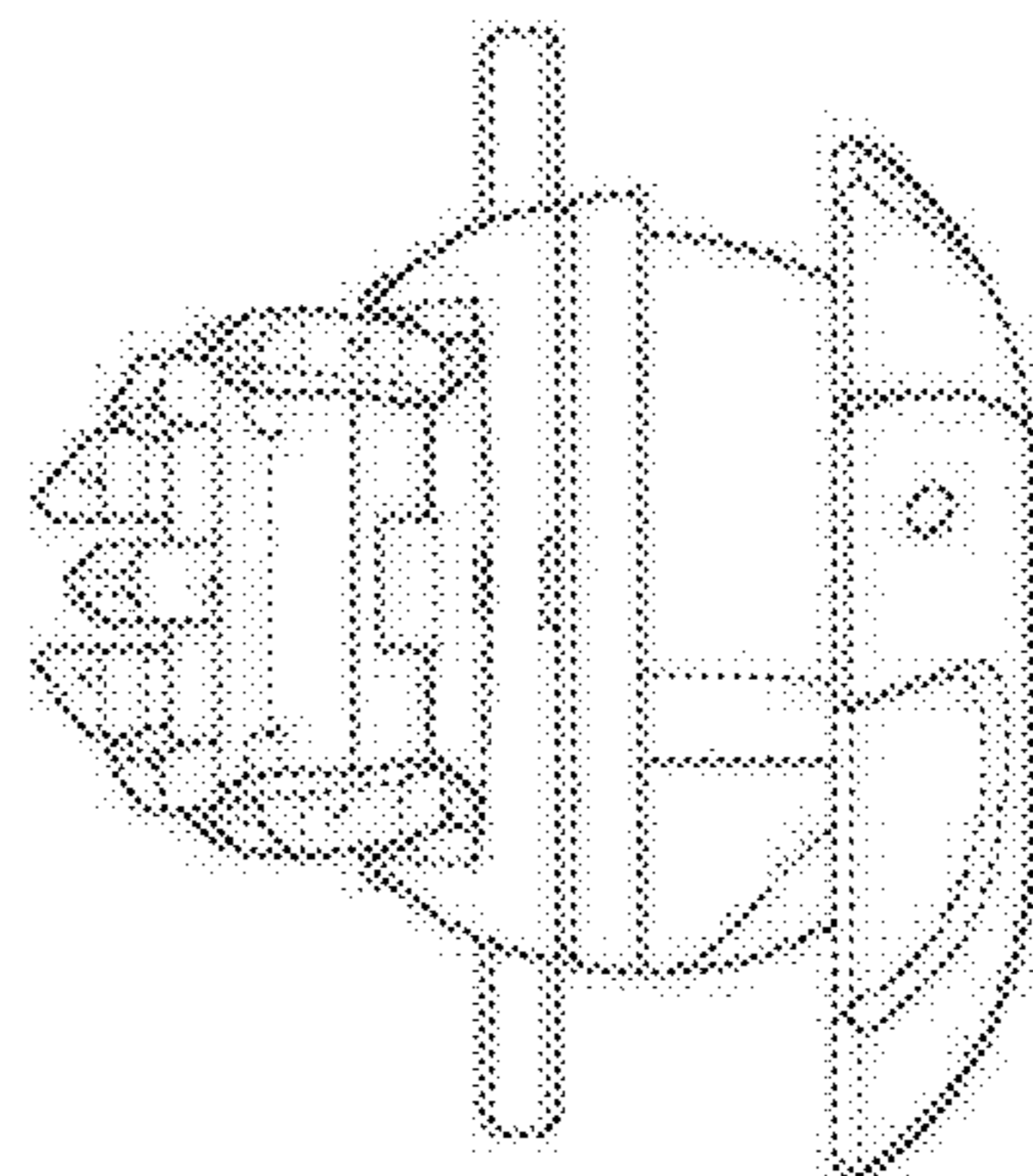

Fig. 33

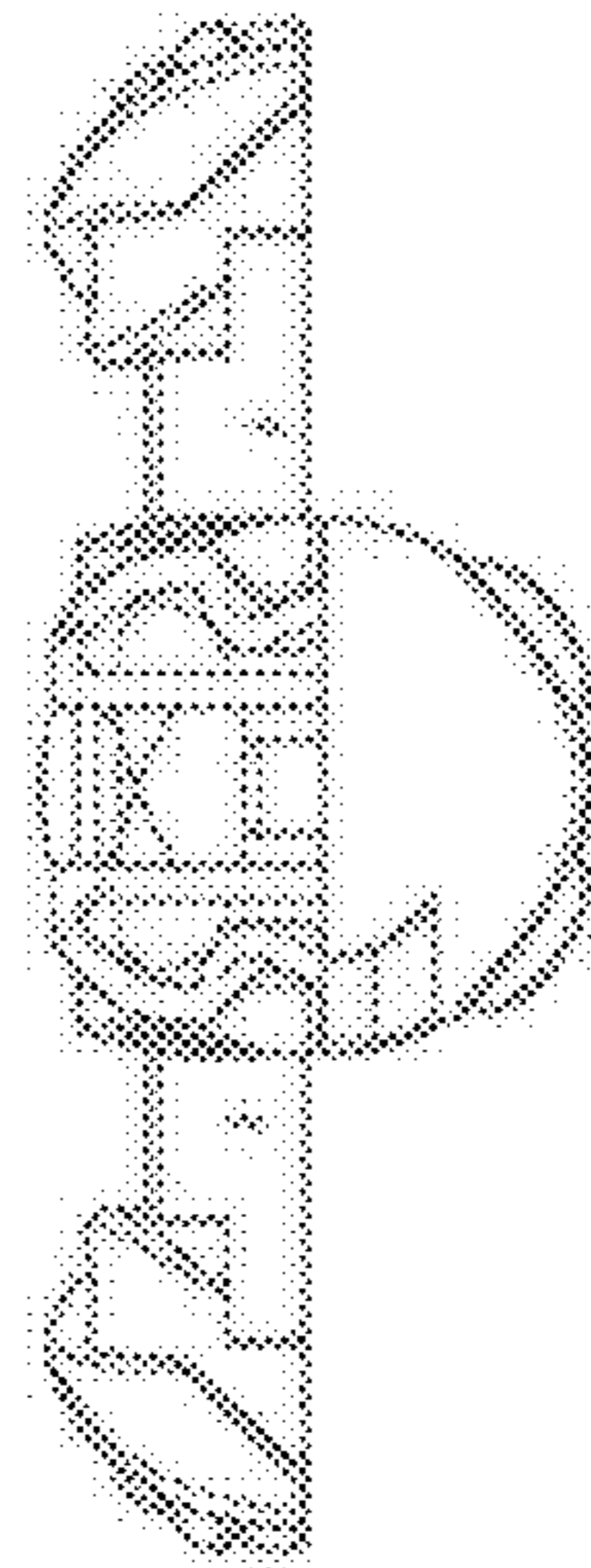

Fig. 34

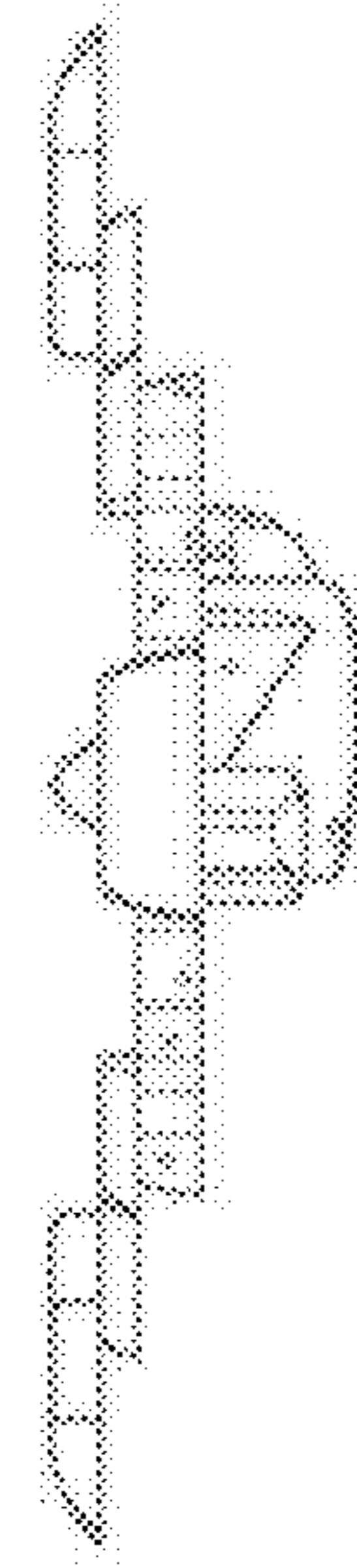

Fig. 35

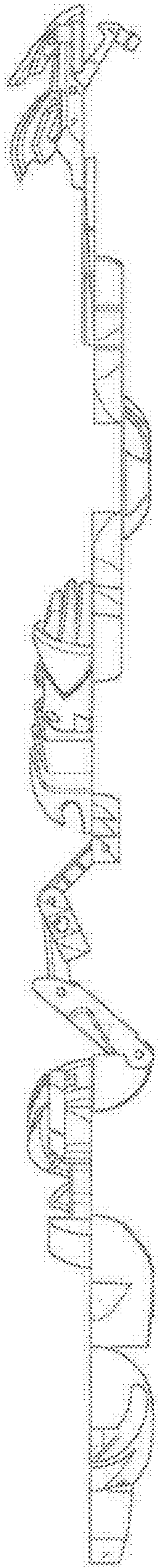

Fig. 36

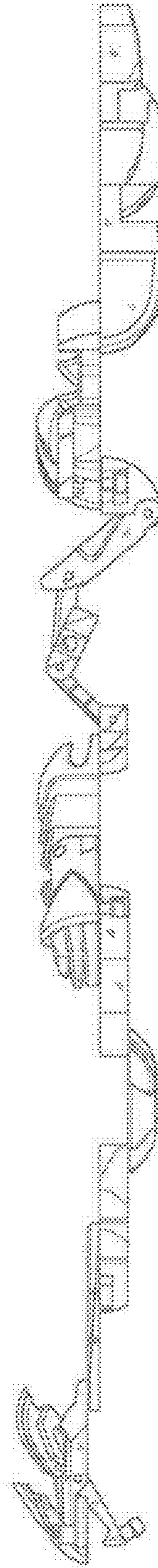

Fig. 37

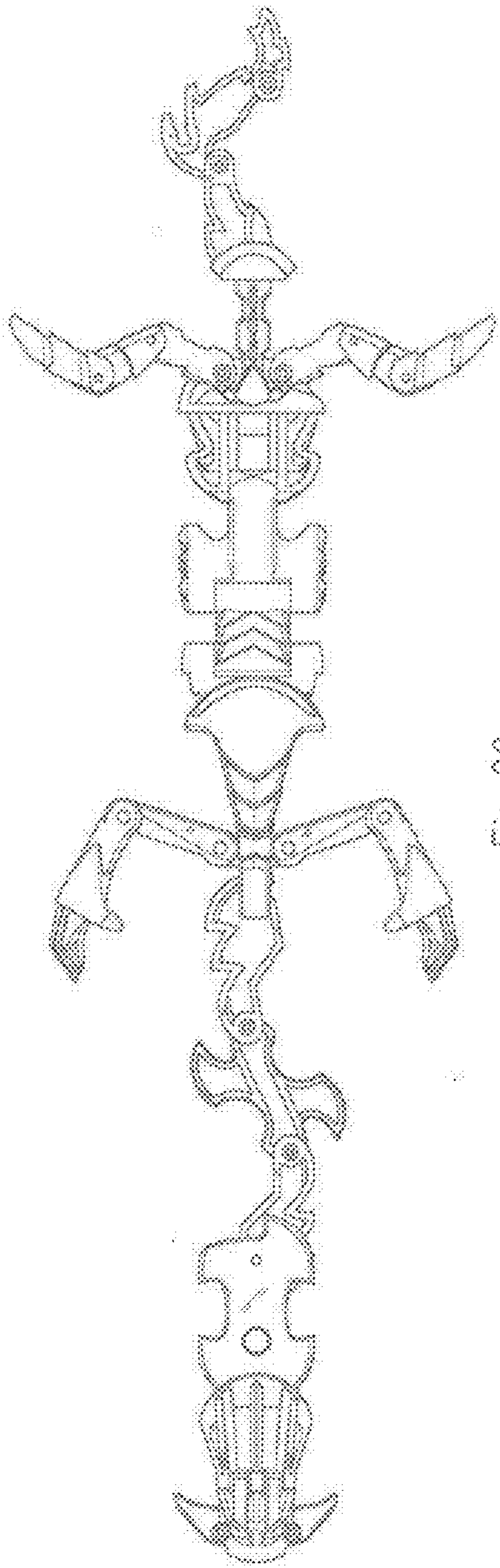

Fig. 38

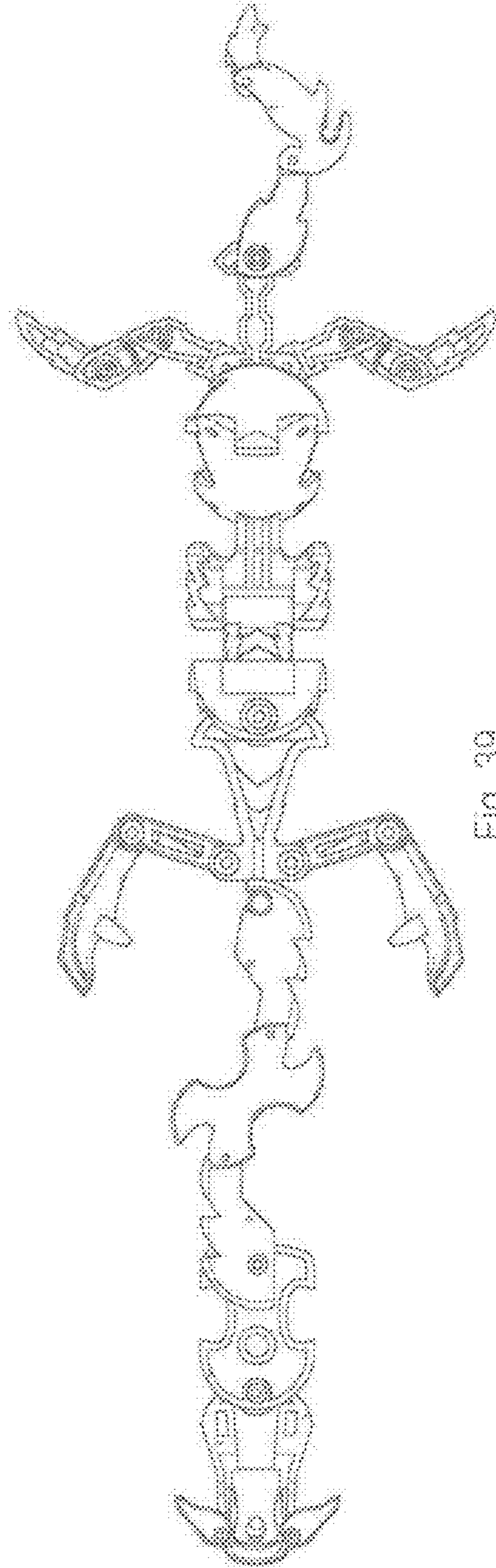

Fig. 39