



US00D721274S

(12) **United States Design Patent**  
**Herbst**

(10) **Patent No.:** **US D721,274 S**  
(45) **Date of Patent:** **\*\* Jan. 20, 2015**

(54) **MISTING HANDPIECE WITH WRAPAROUND ACTUATOR**

D660,941 S \* 5/2012 Perez et al. .... D23/225  
D703,046 S \* 4/2014 Harwood et al. .... D9/448  
D709,763 S \* 7/2014 Swerts ..... D9/448

(71) Applicant: **O2Cool, LLC**, Chicago, IL (US)

**OTHER PUBLICATIONS**

(72) Inventor: **Scot Herbst**, Santa Cruz, CA (US)

Portable Cooling Devices by O2 Cool dated 2014. found online [Sep. 11, 2014] <http://www.o2-cool.com/>.\*

(73) Assignee: **O2Cool, LLC**, Chicago, IL (US)

\* cited by examiner

(\*\*) Term: **14 Years**

*Primary Examiner* — Robert M Spear

(21) Appl. No.: **29/455,209**

*Assistant Examiner* — Marissa J Cash

(22) Filed: **May 17, 2013**

(74) *Attorney, Agent, or Firm* — Knechtel, Demeur & Samlan

(51) **LOC (10) Cl.** ..... **09-07**

(57) **CLAIM**

(52) **U.S. Cl.**  
USPC ..... **D9/448**

I claim the ornamental design for a misting handpiece with wraparound actuator, as shown and described.

(58) **Field of Classification Search**  
USPC ..... D6/542-545; D7/300, 321, 392.1,  
D7/396.2, 500, 507, 509, 510, 511, 900;  
D9/434-449, 452-455, 682, 685;  
215/200, 235, 236, 252, 259, 329,  
215/355-364; 220/200, 203.04-203.07,  
220/220, 254.1, 254.4, 556, 703, 704, 705;  
D28/4, 76, 88, 89, 82, 91.1  
See application file for complete search history.

**DESCRIPTION**

FIG. 1 is a left top front corner perspective view of the misting handpiece with wraparound actuator showing my new design;  
FIG. 2 is an inverted rear perspective view thereof;  
FIG. 3 is a left side view thereof;  
FIG. 4 is a right side view thereof;  
FIG. 5 is a front elevation view thereof;  
FIG. 6 is a rear elevation view thereof;  
FIG. 7 is a top view thereof; and,  
FIG. 8 is a bottom view thereof.  
The broken line showing the valve and fitting forms no part of the claimed design.

(56) **References Cited**

**U.S. PATENT DOCUMENTS**

D275,935 S \* 10/1984 Corba ..... D9/448  
D291,415 S \* 8/1987 Abplanalp ..... D9/448  
D639,160 S \* 6/2011 Jug et al. .... D9/448

**1 Claim, 7 Drawing Sheets**

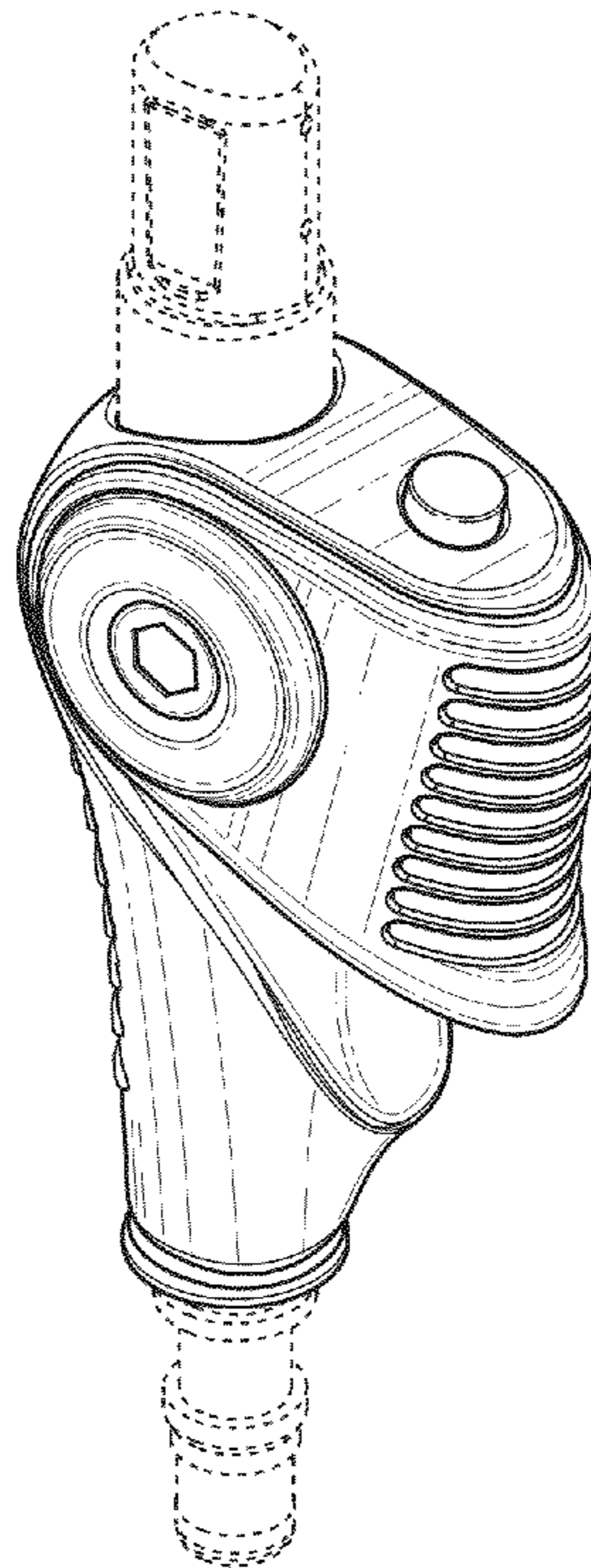

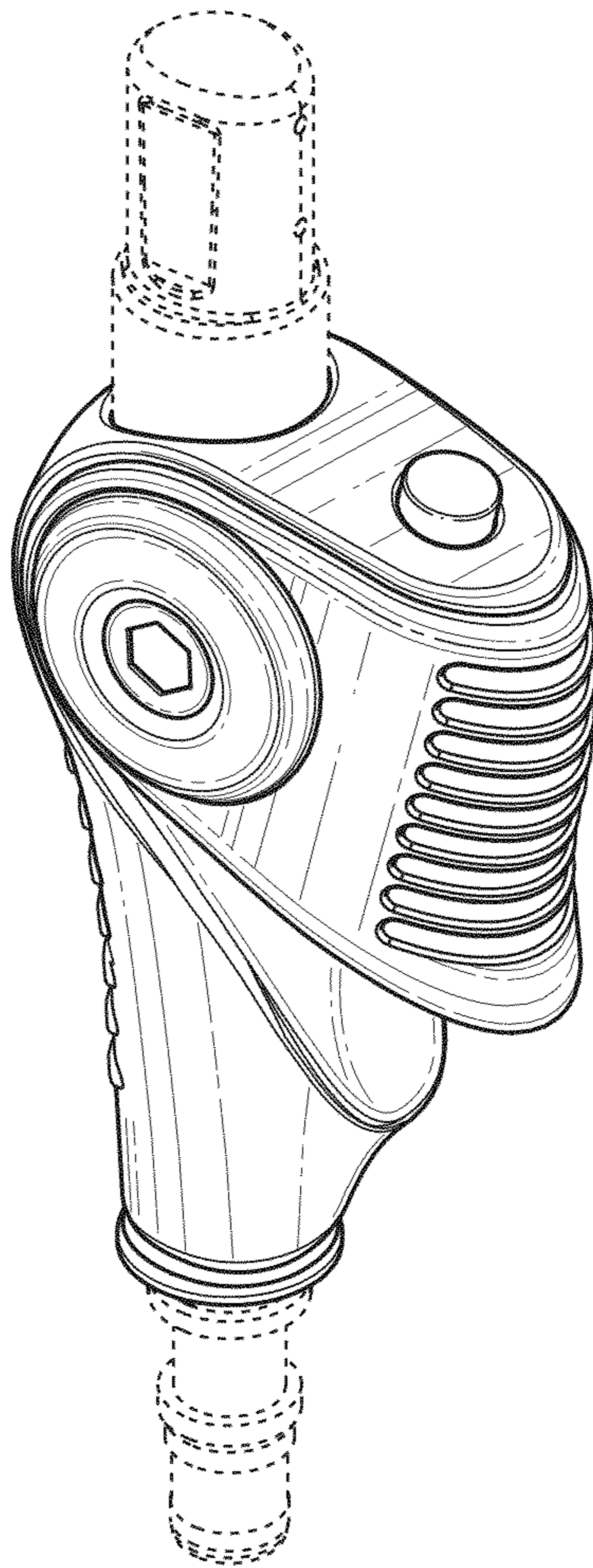

FIG. 1

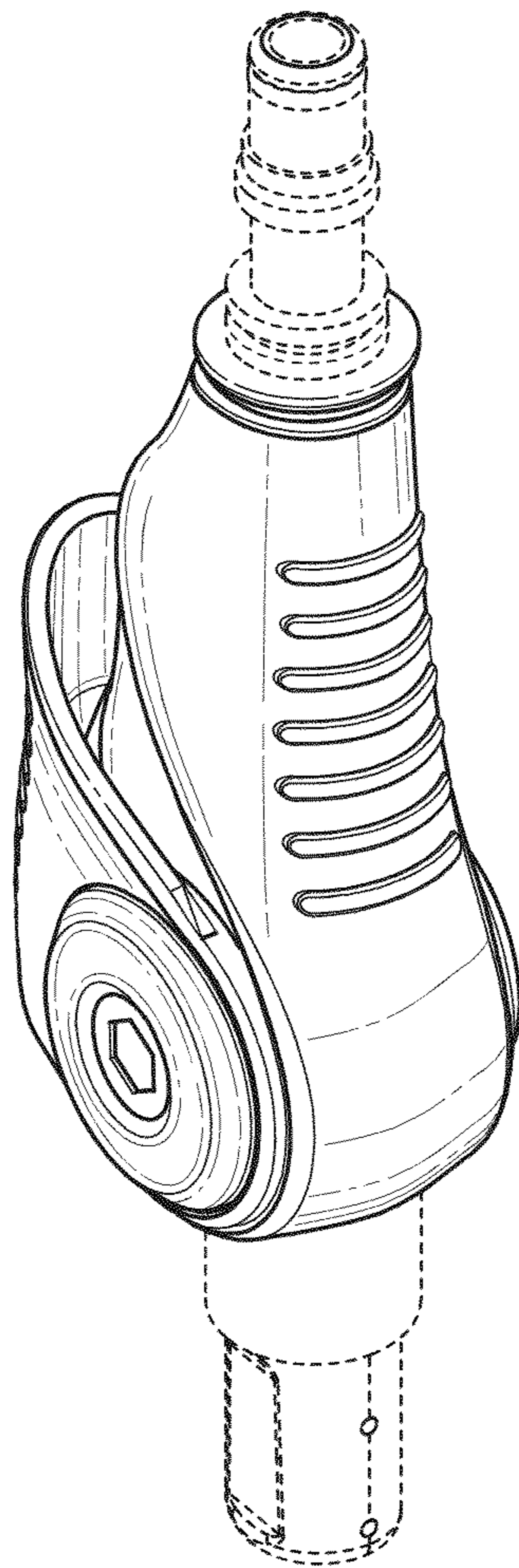

FIG. 2

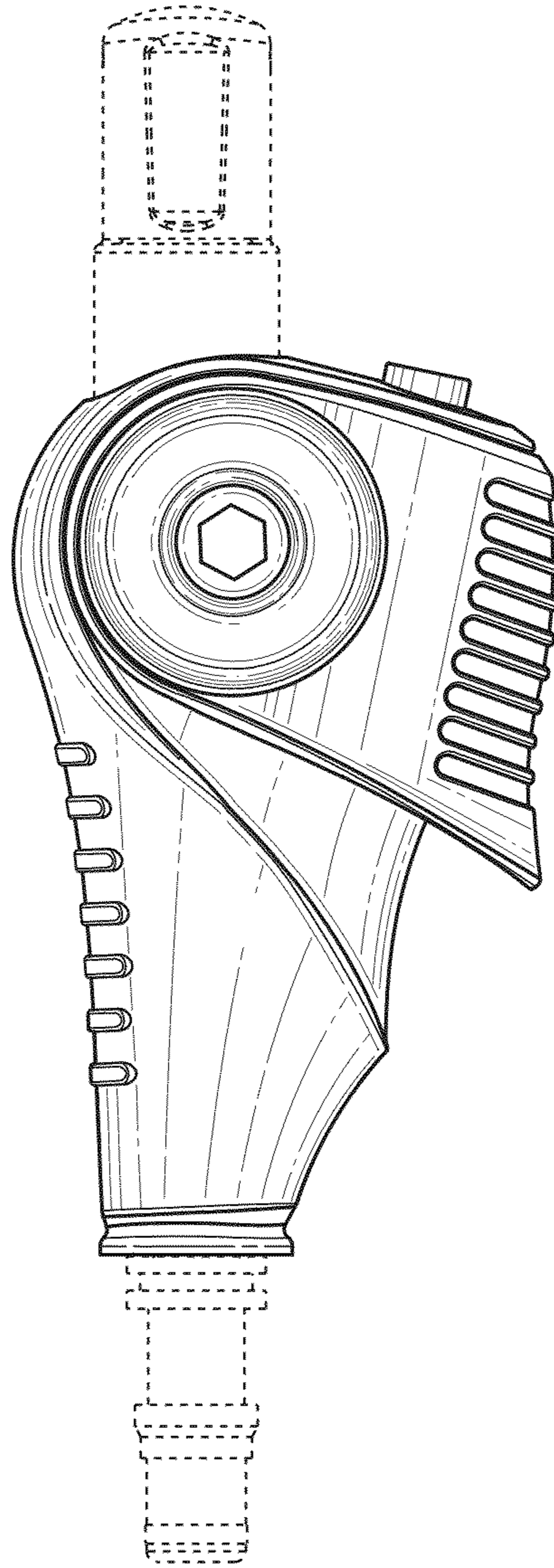

FIG. 3

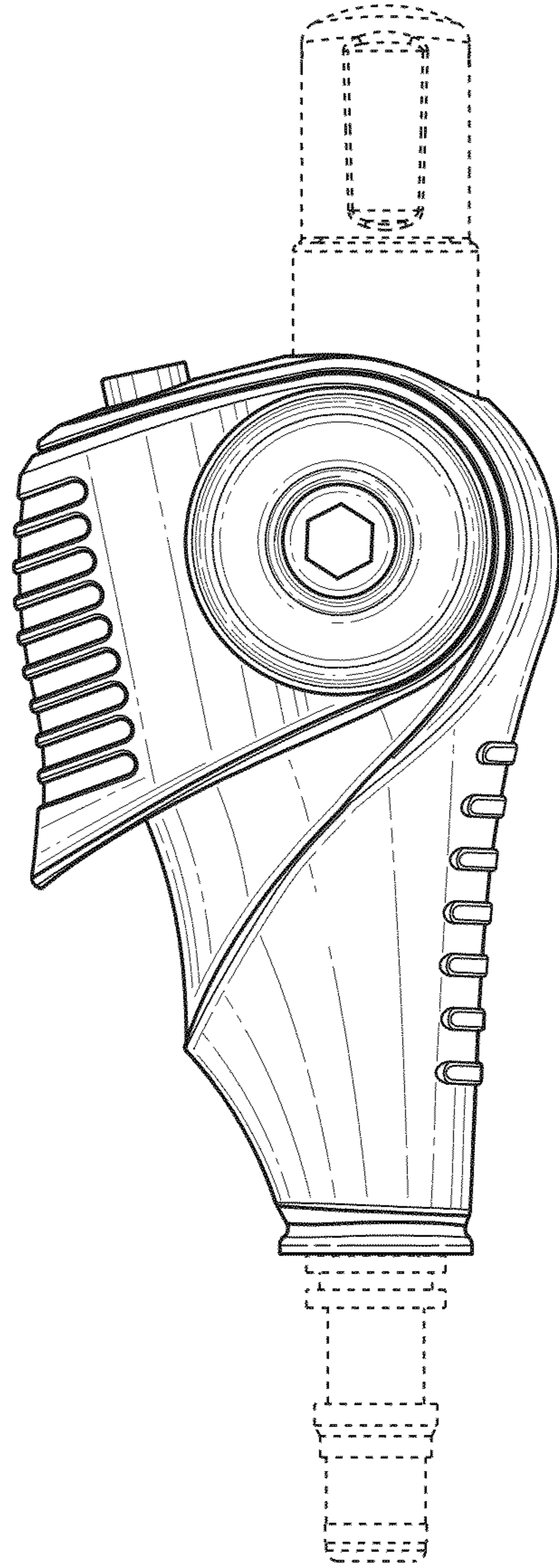

FIG. 4

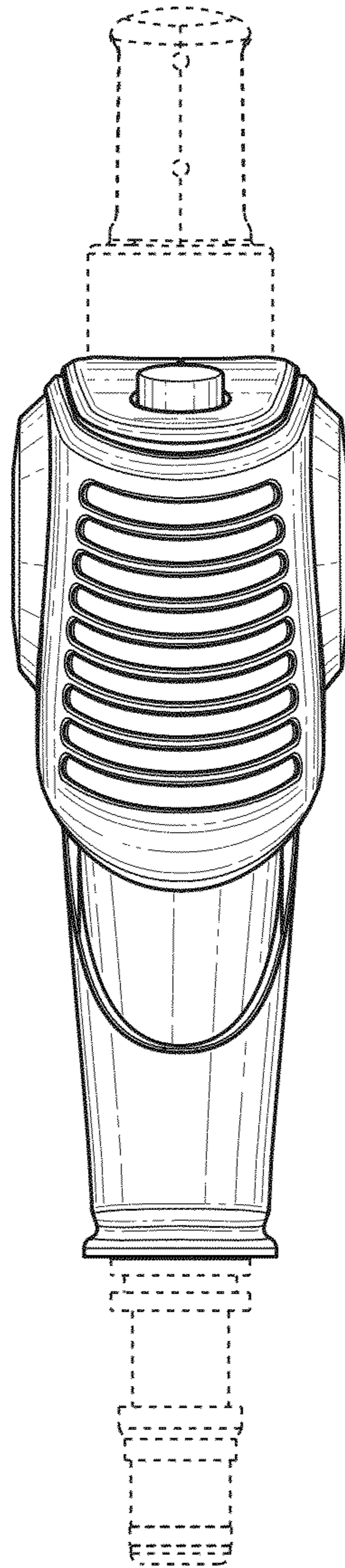

FIG. 5

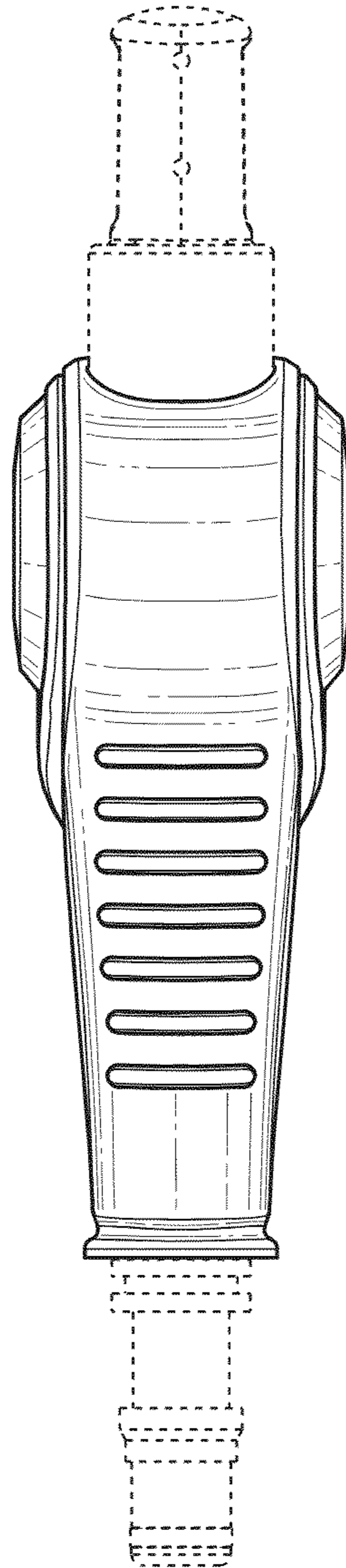

FIG. 6

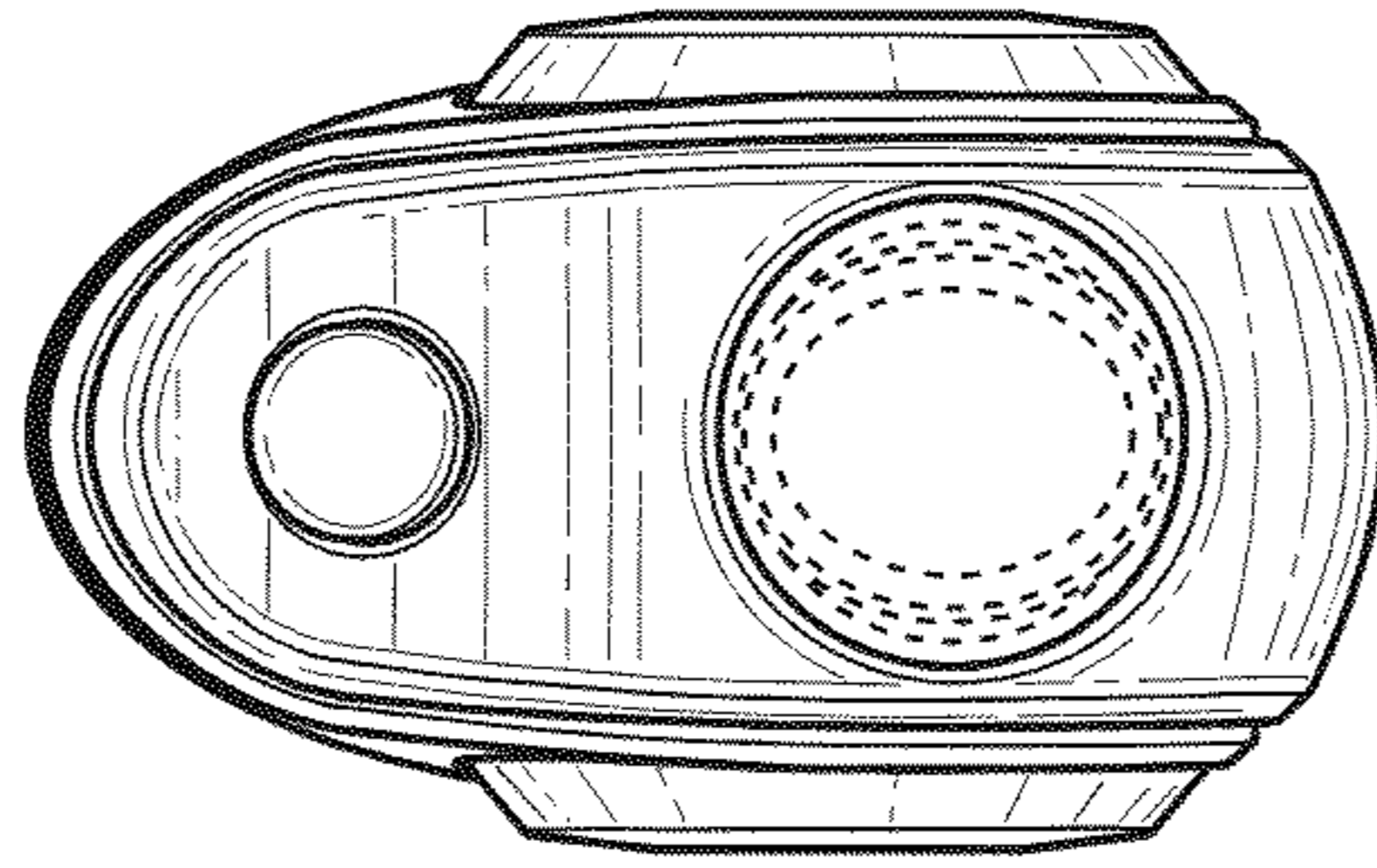

FIG. 7

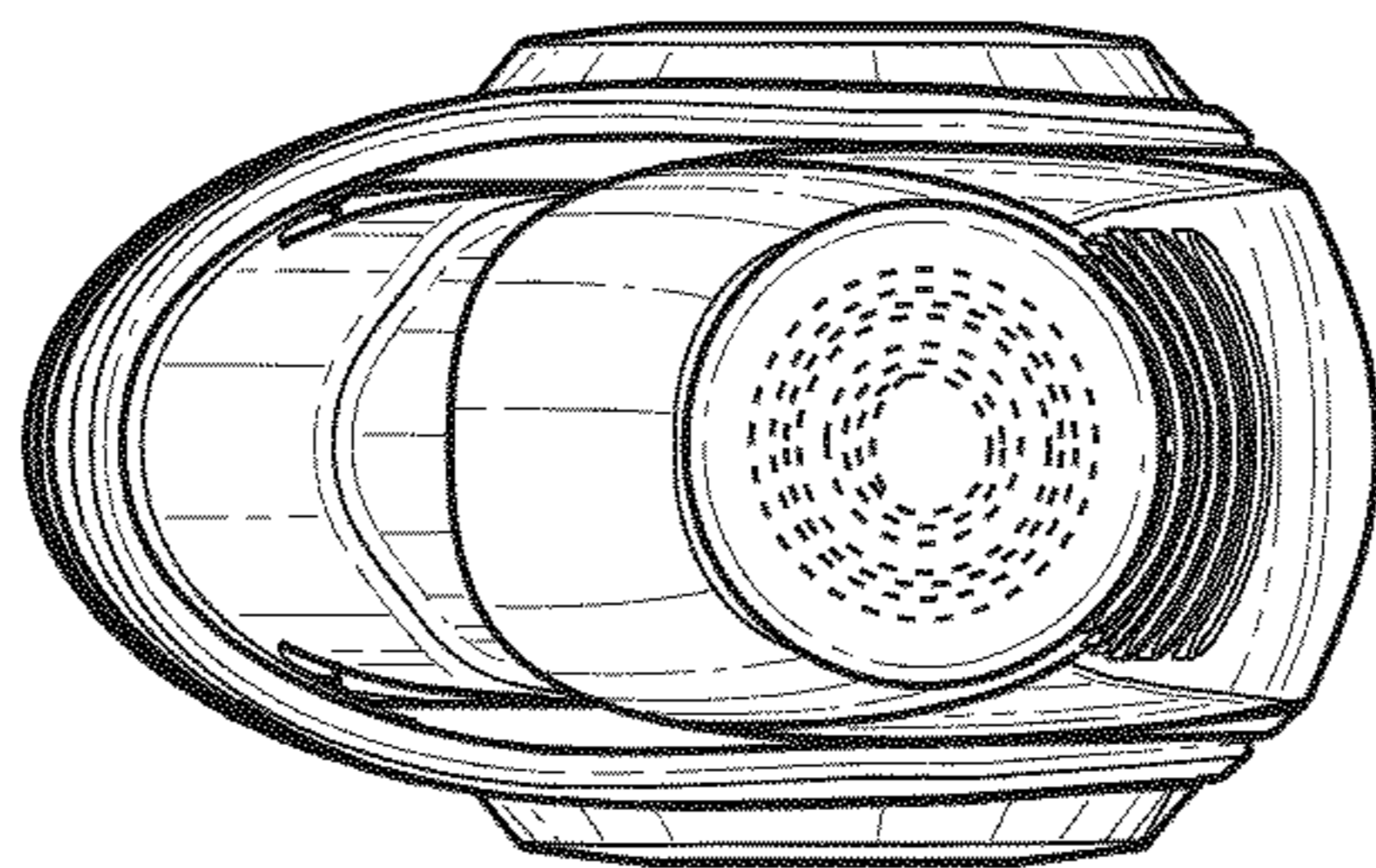

FIG. 8