



US00D721263S

(12) **United States Design Patent**
Reimann et al.

(10) **Patent No.:** **US D721,263 S**
(45) **Date of Patent:** **** Jan. 20, 2015**

(54) **TWINE DISPENSER WITH REMOVABLE CUTTING DEVICE**

(71) Applicants: **Gina Reimann**, Brooklyn, NY (US);
Colin Kelly, Brooklyn, NY (US);
Edward Lee, Brooklyn, NY (US); **Boris Kontorovich**, Brooklyn, NY (US)

(72) Inventors: **Gina Reimann**, Brooklyn, NY (US);
Colin Kelly, Brooklyn, NY (US);
Edward Lee, Brooklyn, NY (US); **Boris Kontorovich**, Brooklyn, NY (US)

(73) Assignee: **Helen of Troy Limited**, St. Michael (BB)

(**) Term: **14 Years**

(21) Appl. No.: **29/483,741**

(22) Filed: **Mar. 2, 2014**

(51) **LOC (10) Cl.** **08-05**

(52) **U.S. Cl.**
USPC **D8/360.1**

(58) **Field of Classification Search**
CPC B65H 59/04; B65H 49/32
USPC 242/129.5, 129.8, 395, 397, 398, 405.3,
242/405, 423.2, 443, 532.6; D3/23, 24;
D8/354, 356, 358, 360.1; D9/549
See application file for complete search history.

(56) **References Cited**

U.S. PATENT DOCUMENTS

82,167	A *	9/1868	Smith et al.	225/47
1,081,716	A *	12/1913	Boulais	242/128
1,179,890	A *	4/1916	Boynton et al.	242/137.1
1,626,545	A *	4/1927	March	242/146
1,692,132	A *	11/1928	Martz	242/129.8
1,784,258	A *	12/1930	Tynan	225/91
2,222,921	A *	11/1940	Berend Van Den Bergh	242/137.1
2,479,826	A *	8/1949	Frick et al.	242/128
2,550,944	A *	5/1951	Stack	225/44

2,580,129	A *	12/1951	Rich	242/129.8
2,678,780	A *	5/1954	Klein	242/118.7
3,389,323	A *	6/1968	Jepson et al.	320/115
3,502,281	A *	3/1970	McLain	242/137.1
3,811,639	A *	5/1974	Jordan	242/129.8
3,856,232	A *	12/1974	Rinaldi	242/146
3,879,002	A *	4/1975	McClain et al.	242/137.1
D236,808	S *	9/1975	Hardy	D3/23
4,050,648	A *	9/1977	Tisma	242/129.8
D256,776	S *	9/1980	Monnet	D9/500
D333,422	S *	2/1993	Nowotny et al.	D8/358
5,966,821	A *	10/1999	Armbruster et al.	30/537
7,438,010	B2 *	10/2008	Lyman	112/302

* cited by examiner

Primary Examiner — Adir Aronovich

Assistant Examiner — Ethiene Salgado-Rodriguez

(57) **CLAIM**

The ornamental design for a twine dispenser with removable cutting device, as shown and described.

DESCRIPTION

FIG. 1 is a front elevational view of a twine dispenser with removable cutting device showing our new design;
 FIG. 2 is a left side elevational view thereof;
 FIG. 3 is a rear elevational view thereof;
 FIG. 4 is a right side elevational view thereof;
 FIG. 5 is a top plan view thereof;
 FIG. 6 is a bottom plan view thereof;
 FIG. 7 is a top, front and right perspective view thereof;
 FIG. 8 is a top, front and right perspective view thereof, shown in a use environment;
 FIG. 9 is a front elevational view thereof, shown in a use environment with its lid removed;
 FIG. 10 is a rear elevational view of the cutting device, the twine dispenser removed for ease of illustration;
 FIG. 11 is a rear perspective view thereof; and,
 FIG. 12 is a top plan view thereof.

The broken lines showing a fragment of thread and a thread roll in FIGS. 8 and 9 are shown to illustrate environment and form no part of the claimed design.

1 Claim, 12 Drawing Sheets

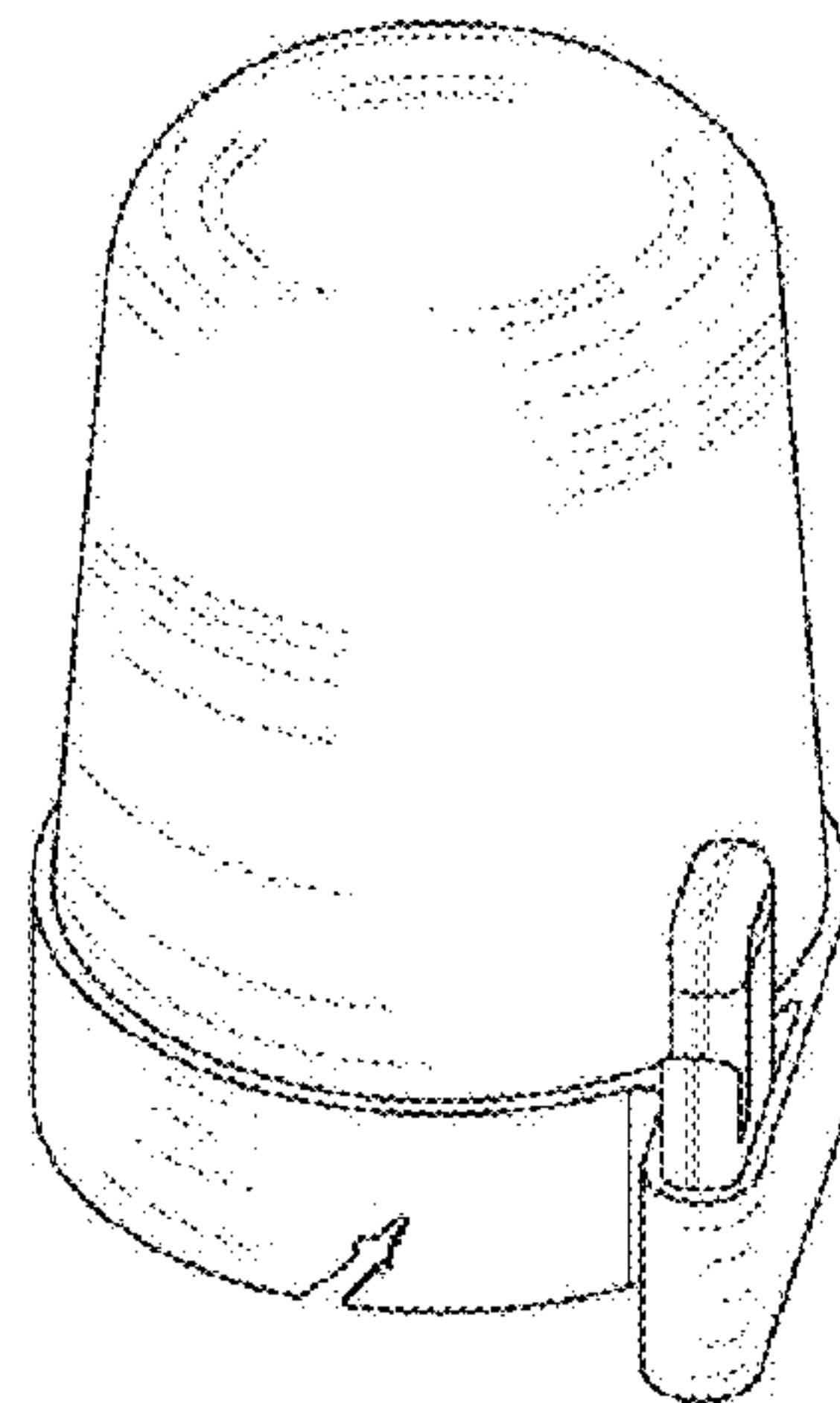

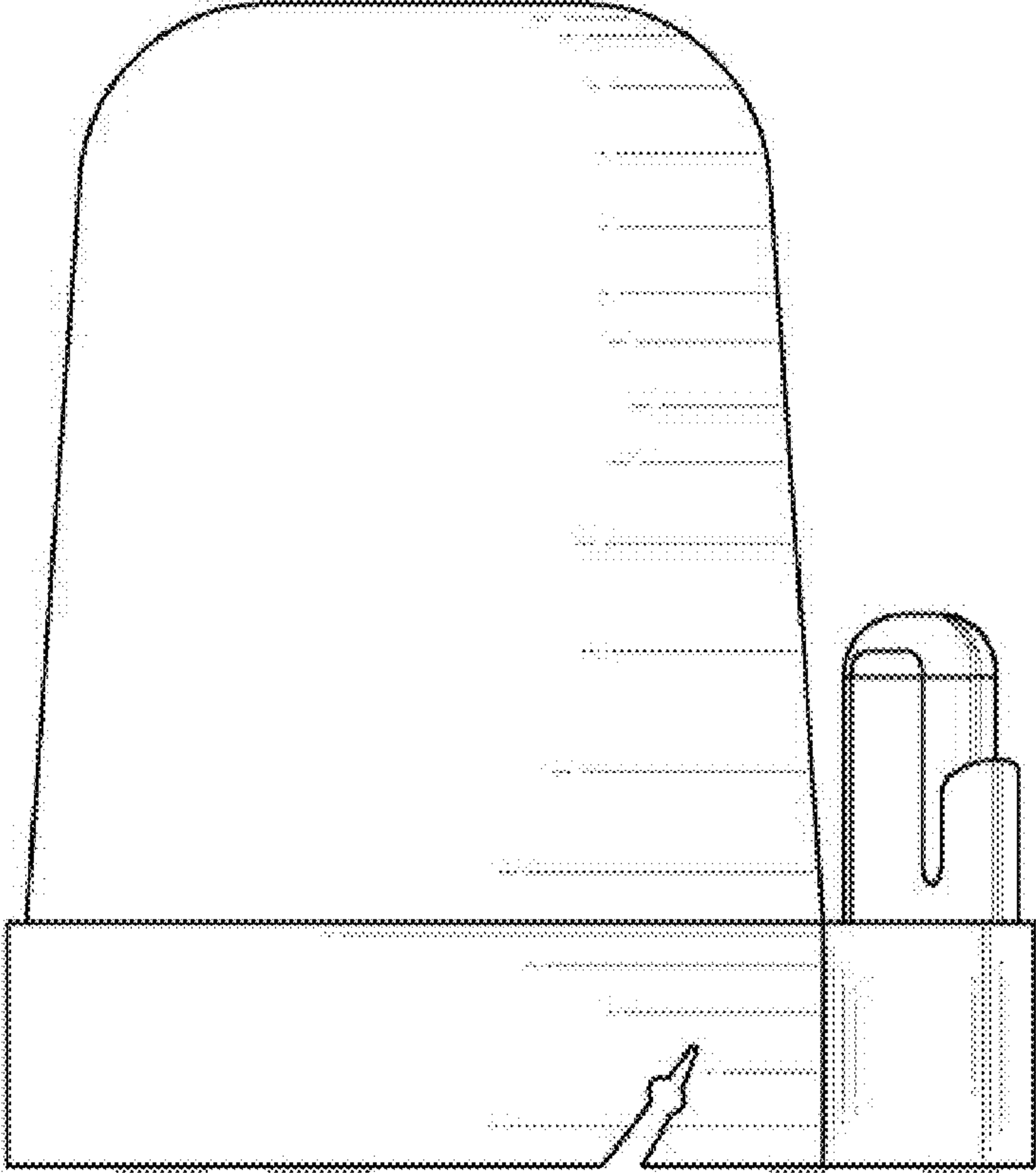

Figure 1

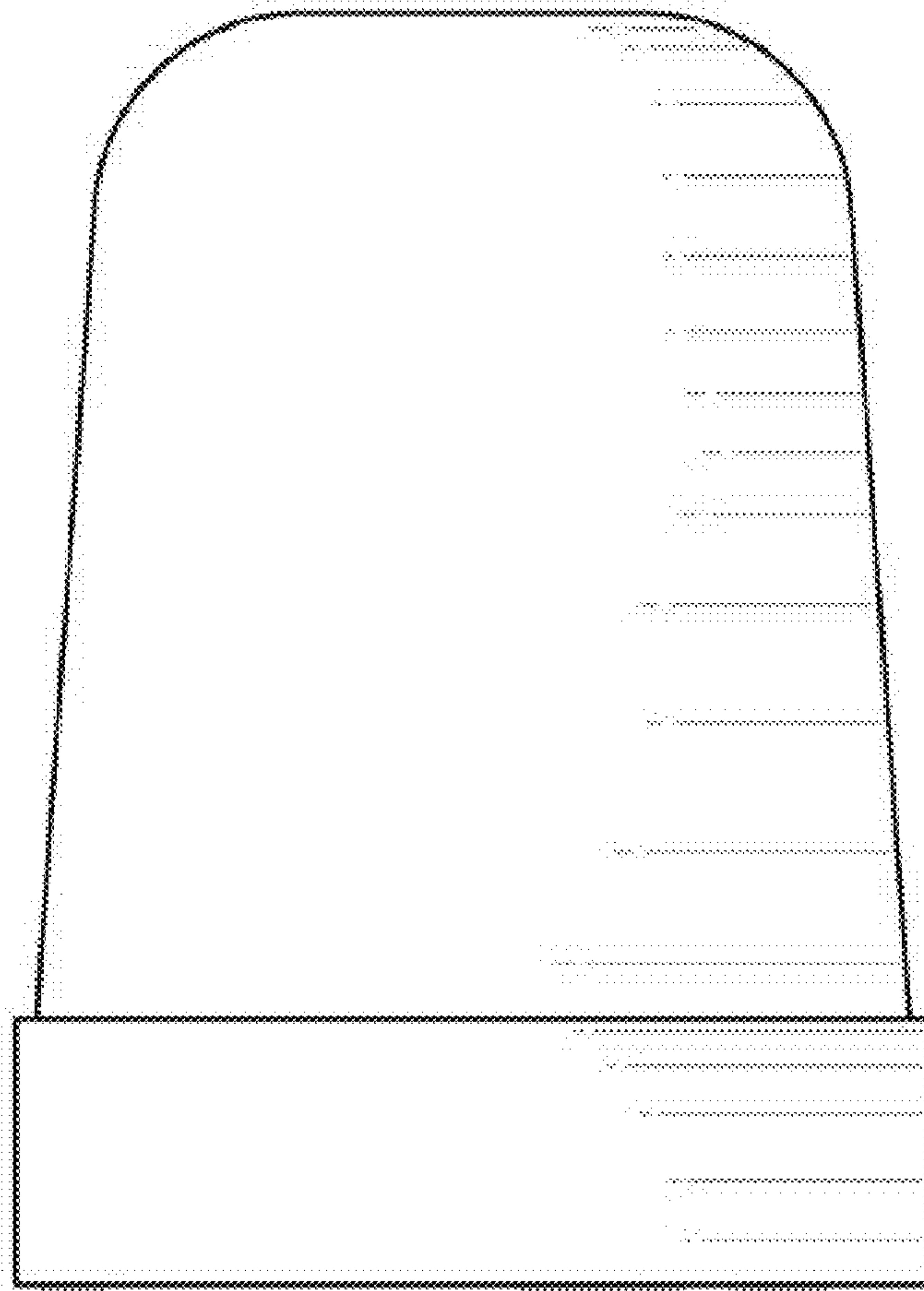

Figure 2

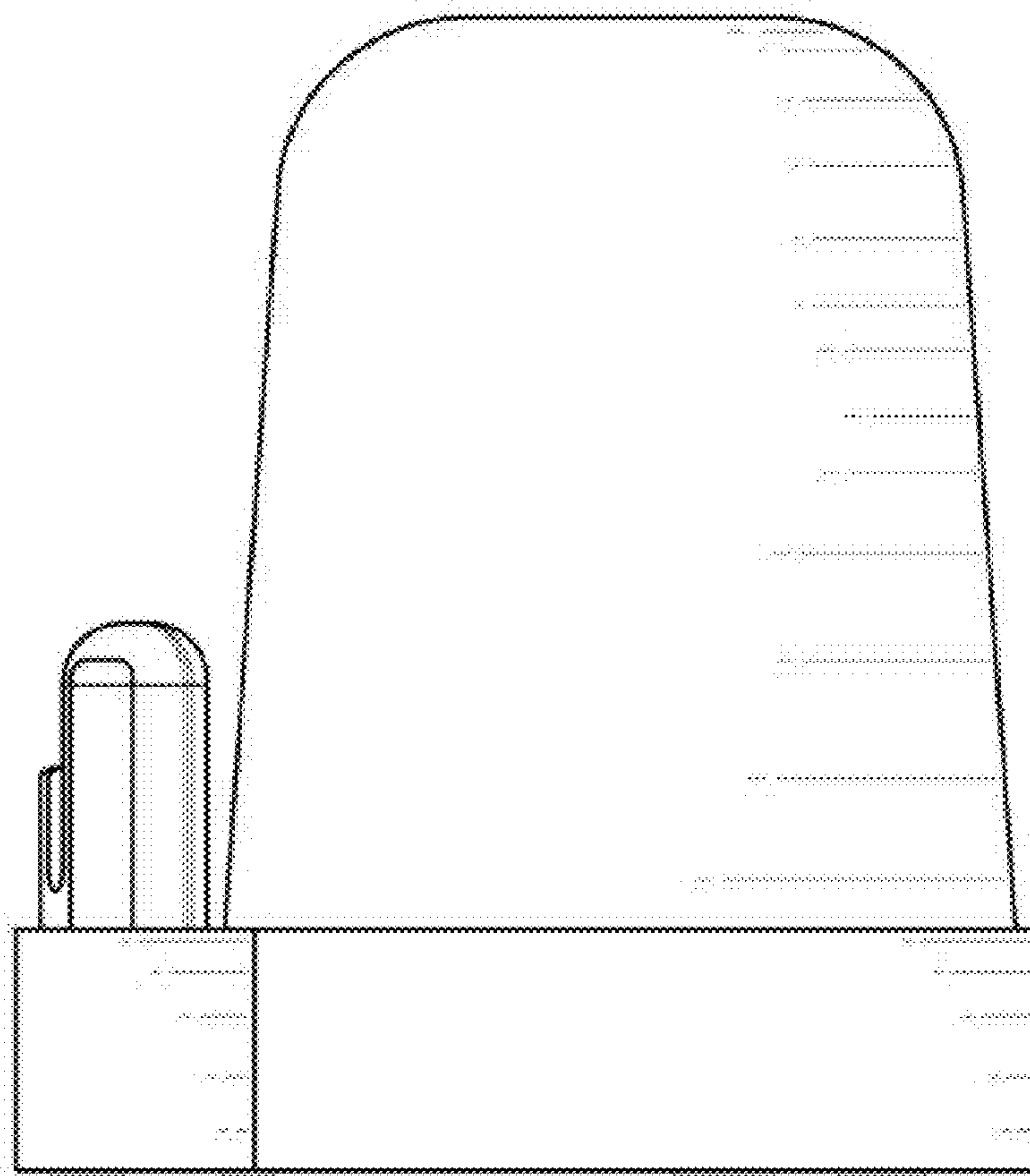

Figure 3

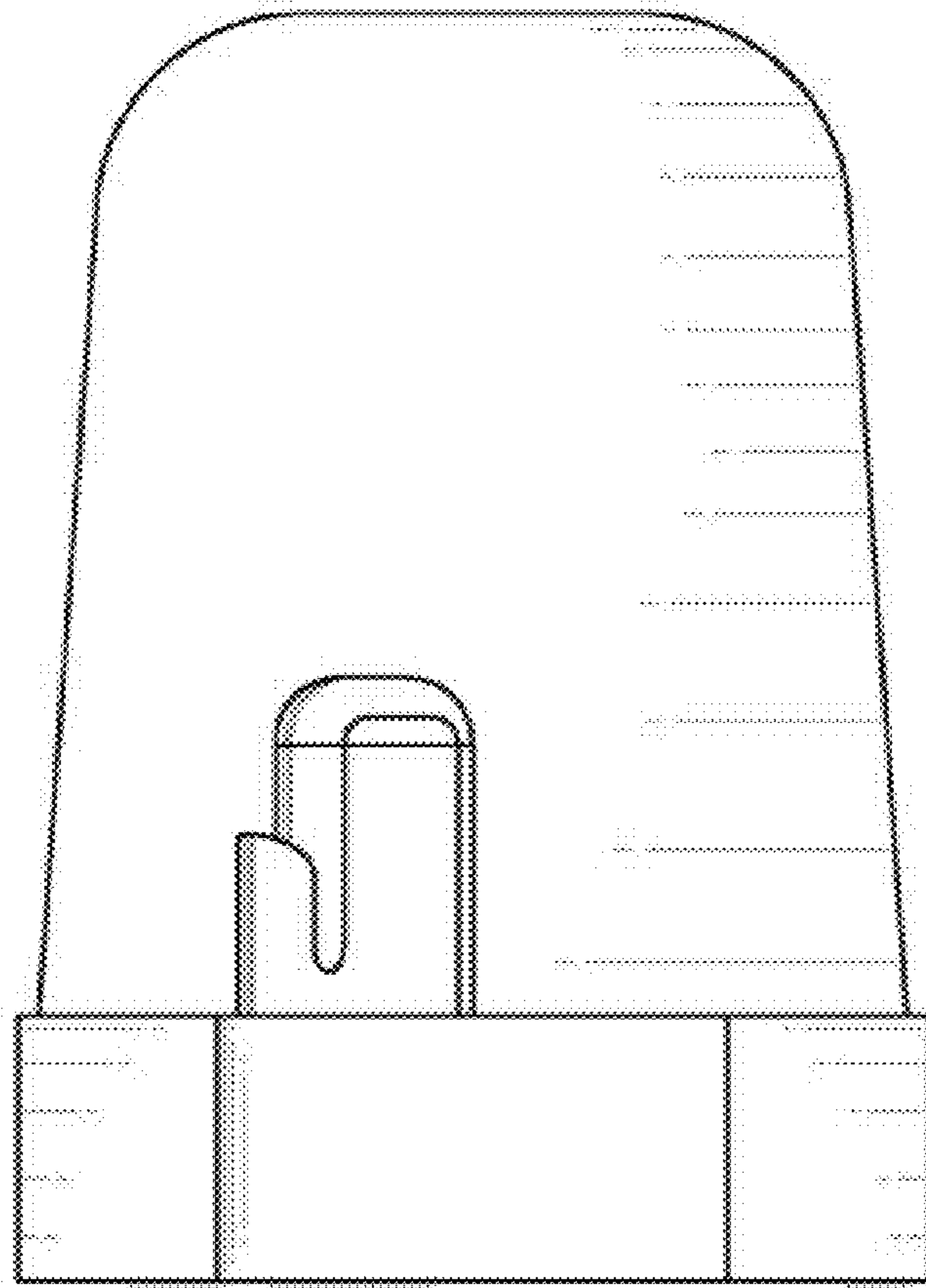

Figure 4

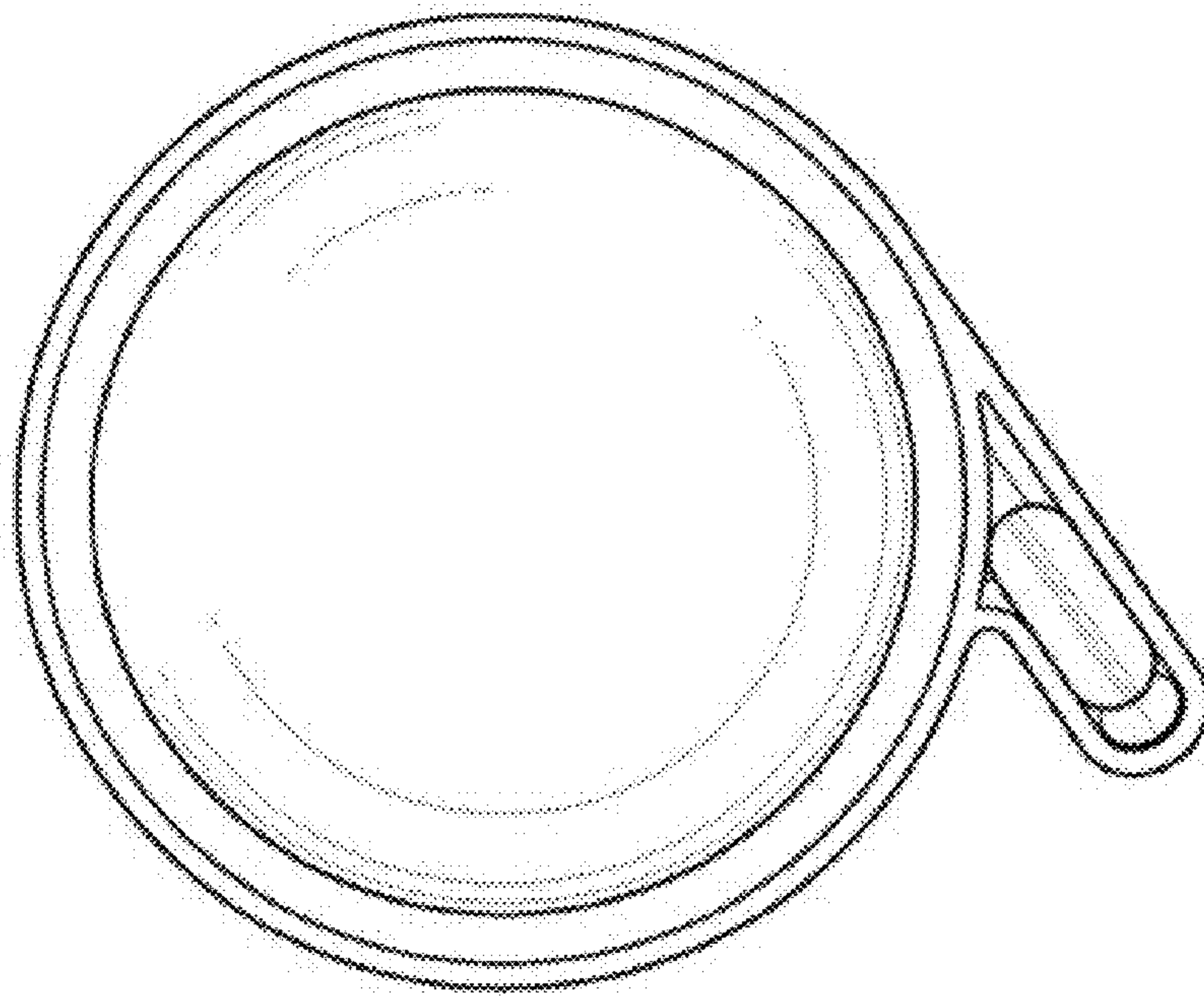

Figure 5

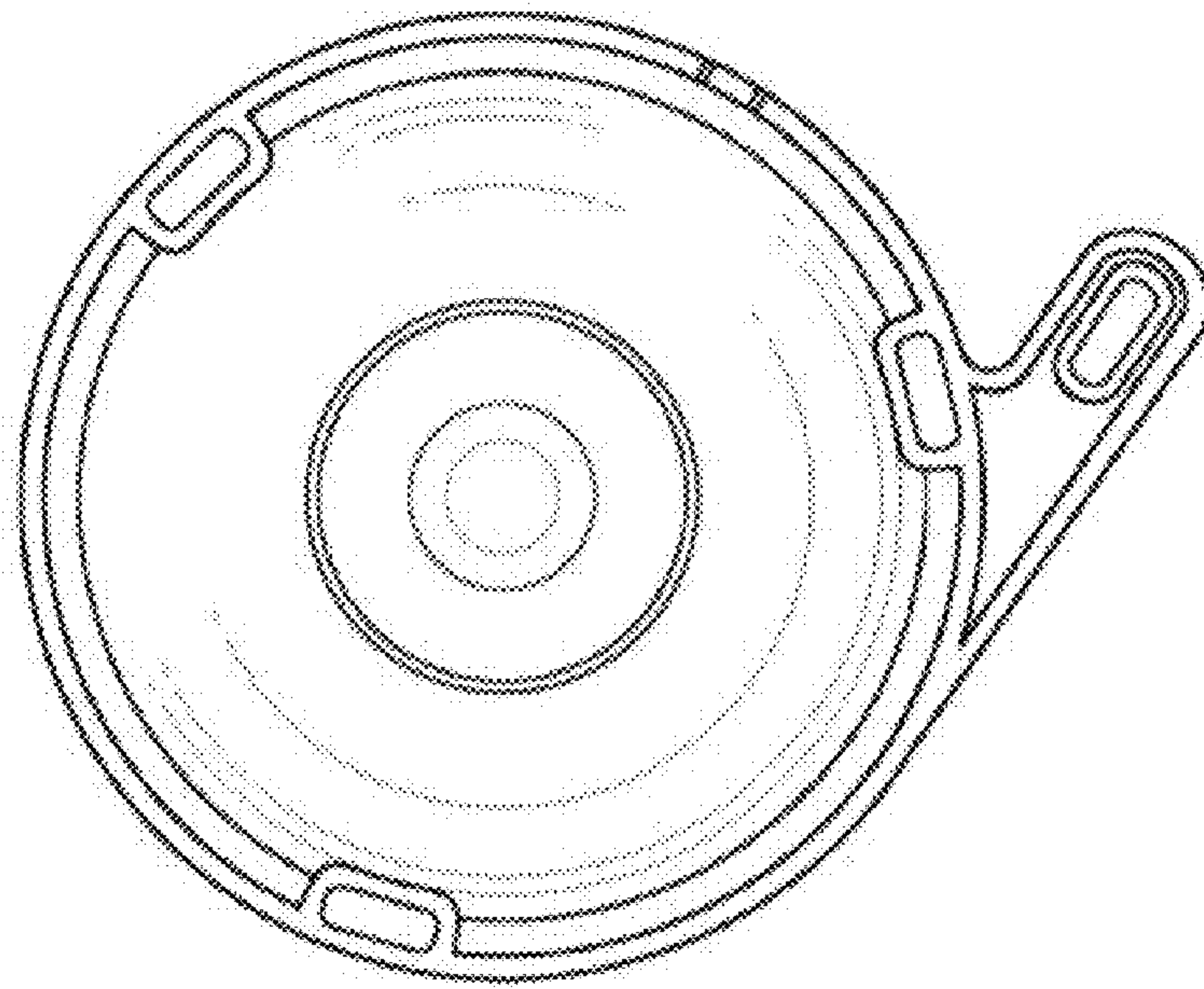

Figure 6

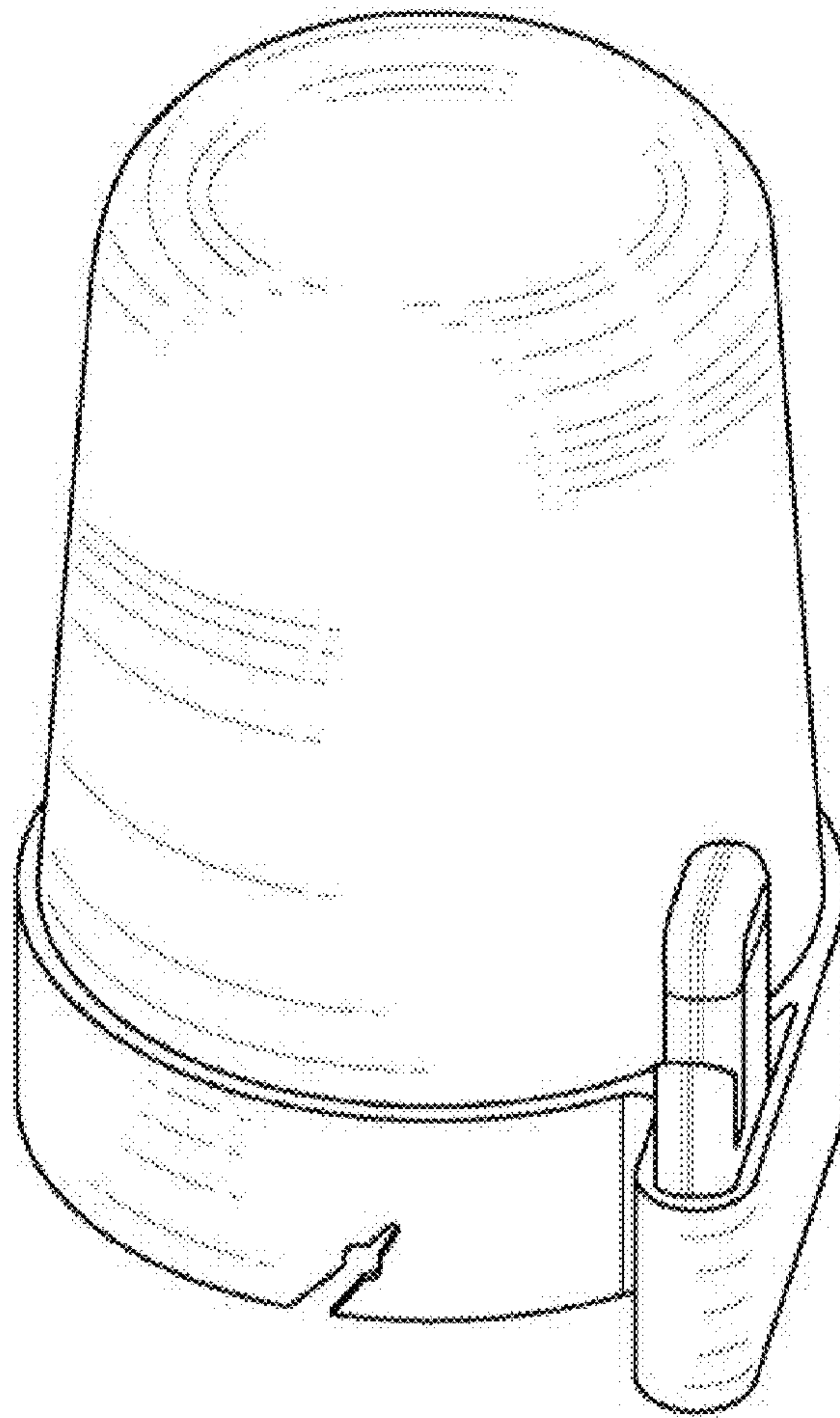

Figure 7

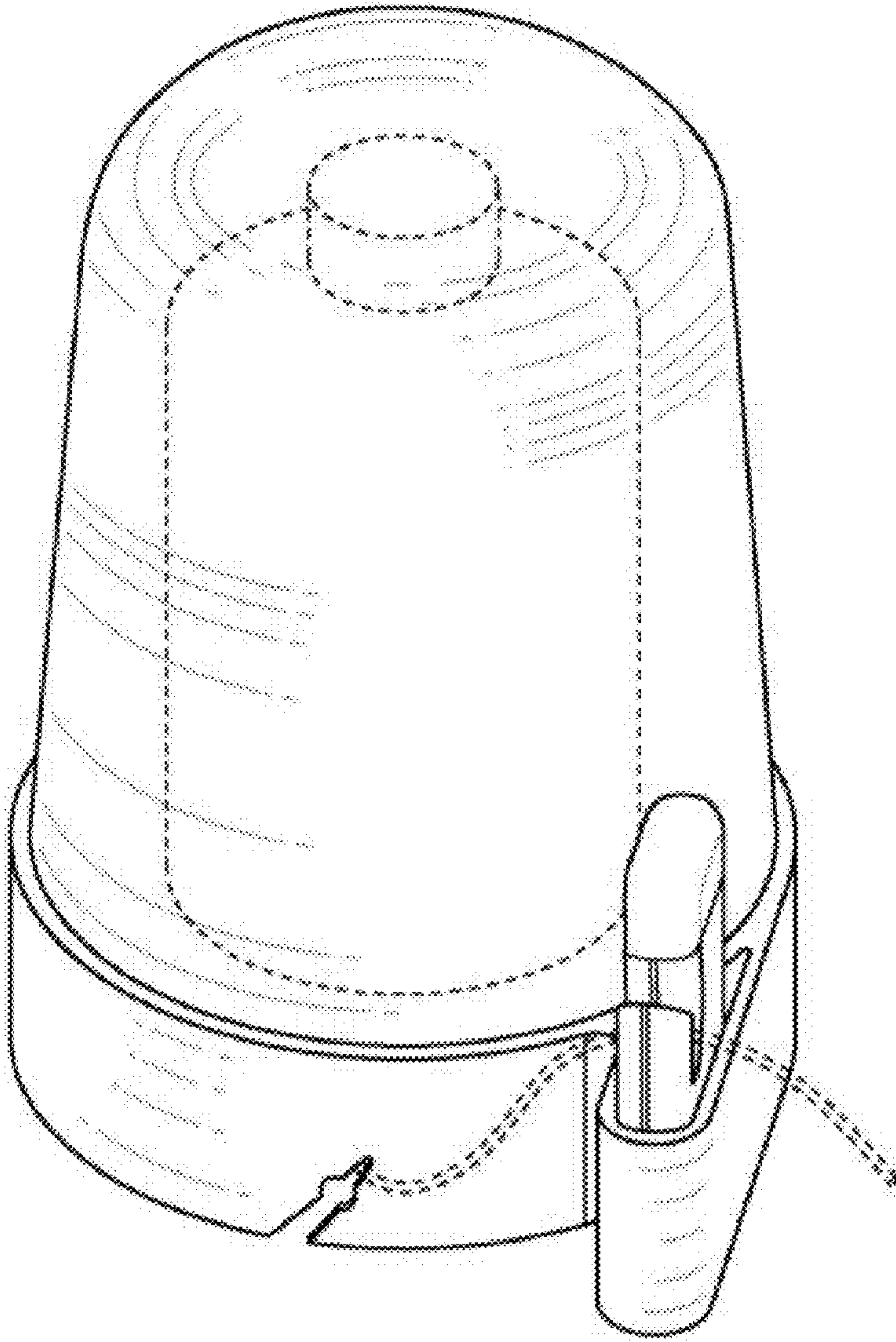

Figure 8

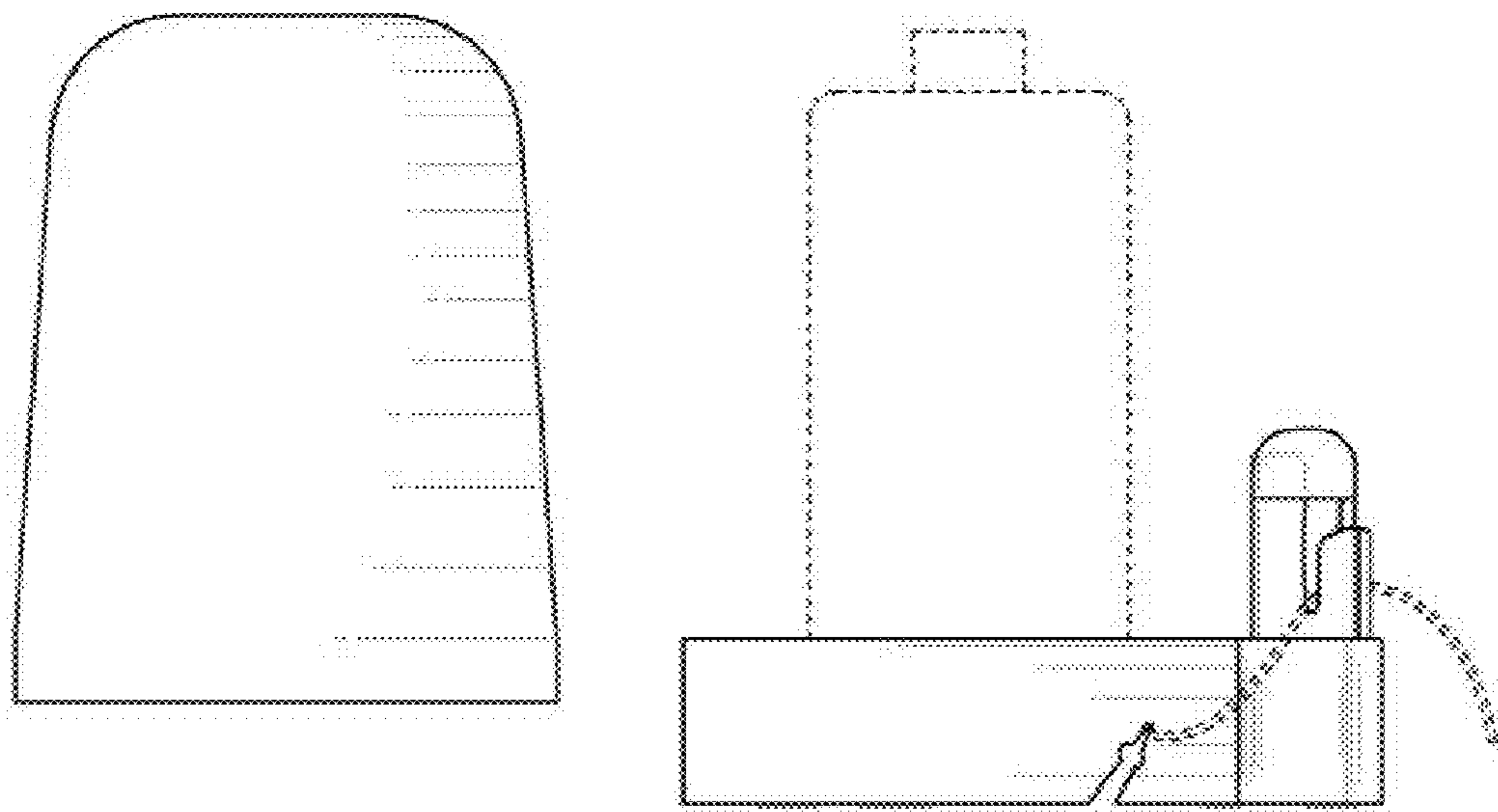

Figure 9

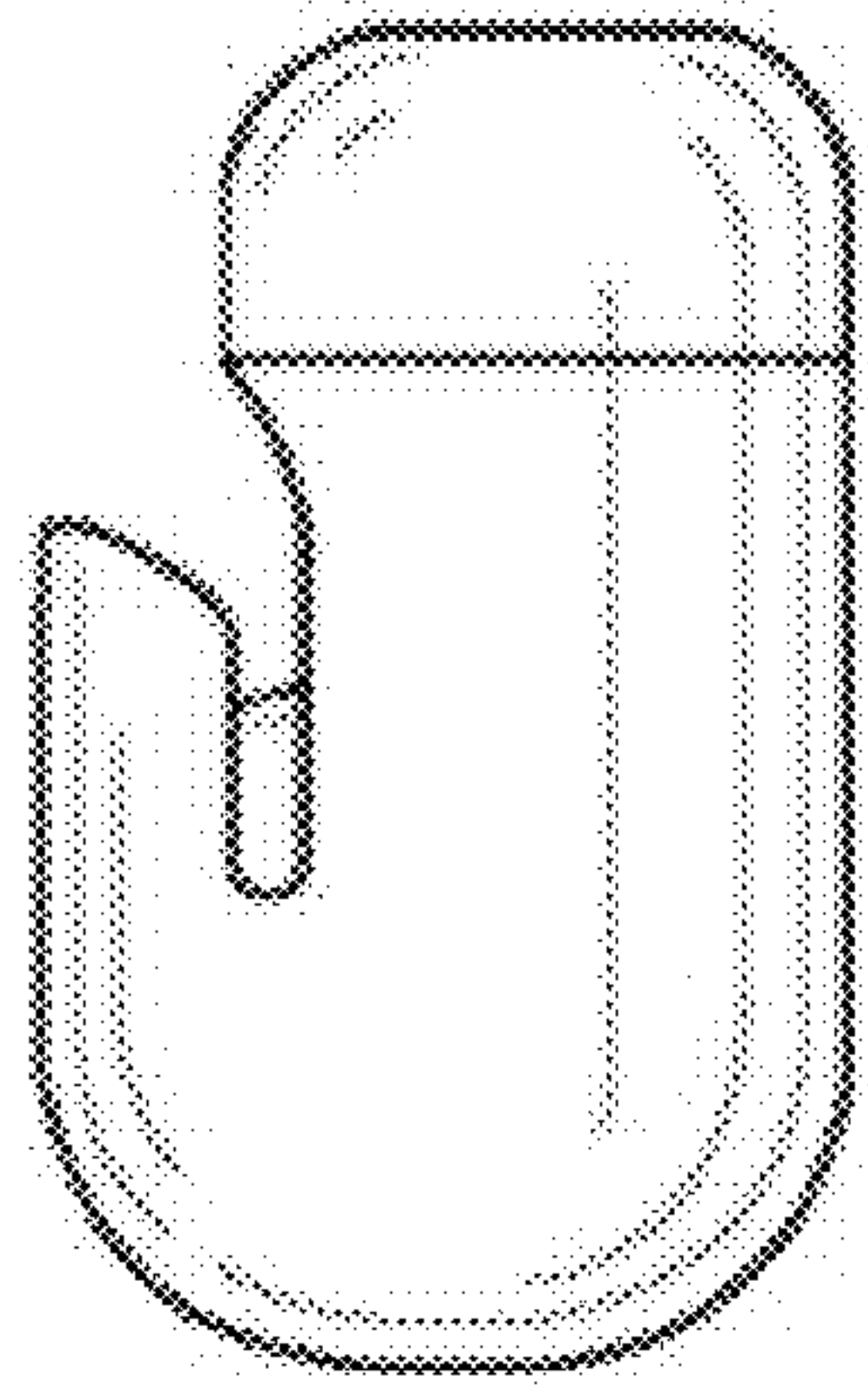

Figure 10

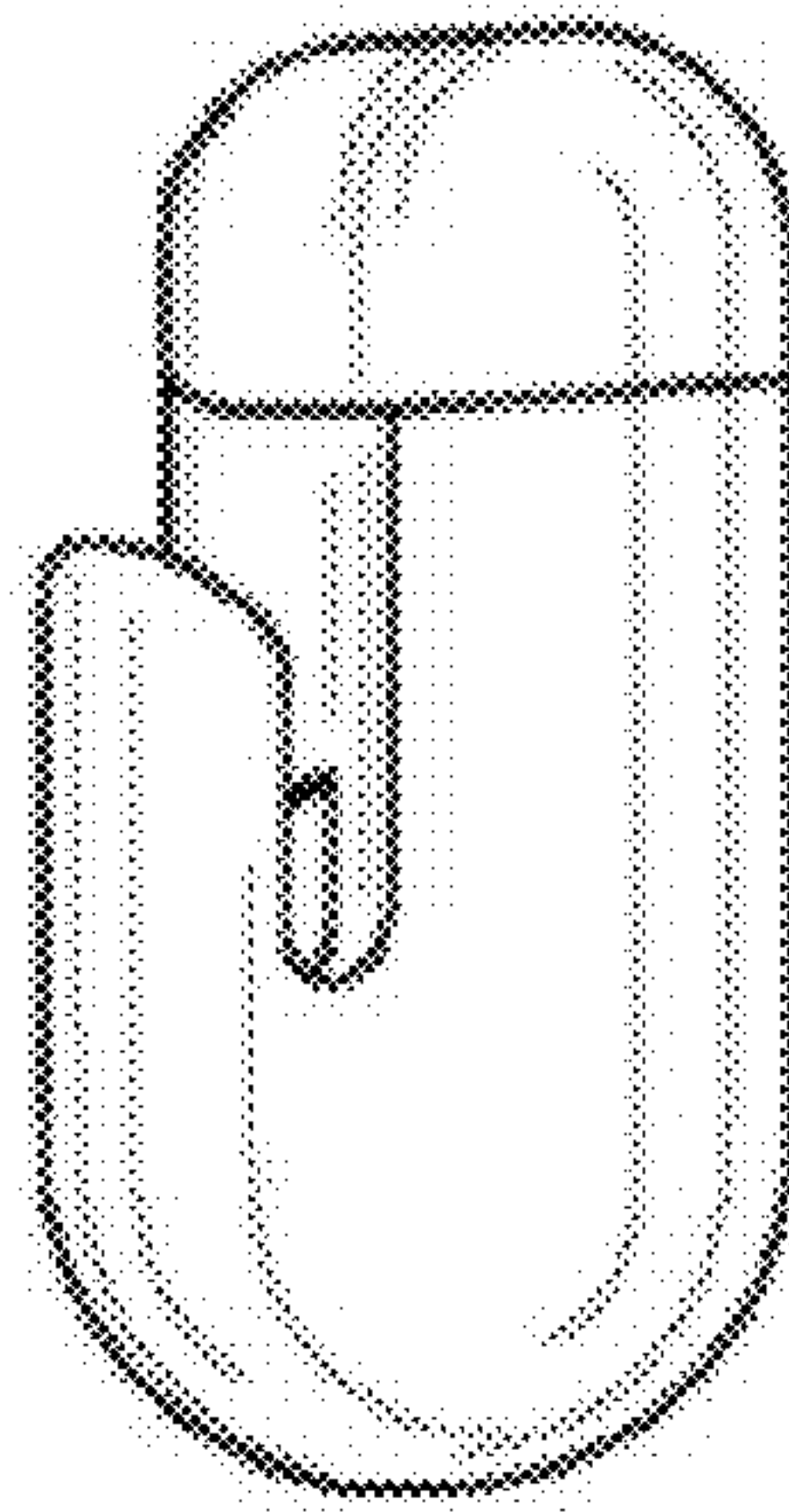

Figure 11

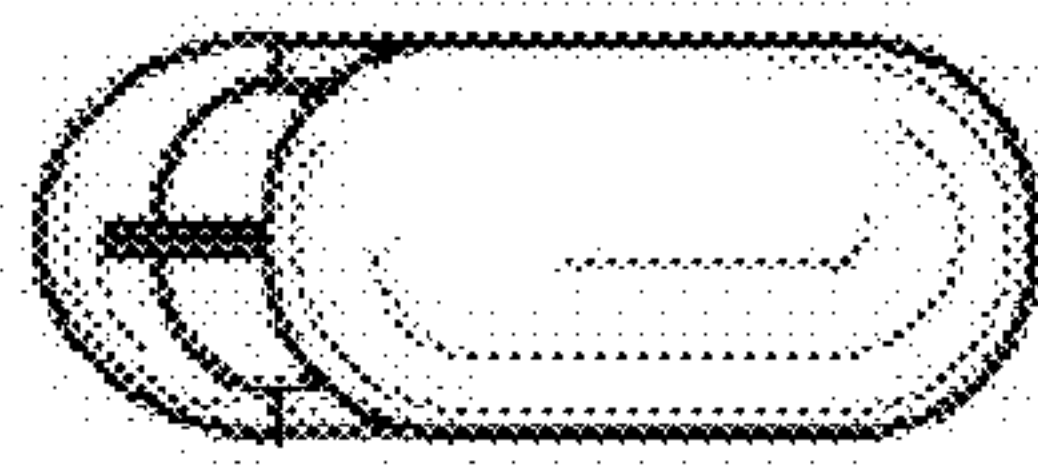

Figure 12