

US00D721138S

(12) **United States Design Patent**
Barinaga et al.

(10) **Patent No.:** **US D721,138 S**

(45) **Date of Patent:** **** *Jan. 13, 2015**

(54) **GAME CONSOLE**

(56) **References Cited**

(71) Applicant: **Valve Corporation**, Bellevue, WA (US)

U.S. PATENT DOCUMENTS

(72) Inventors: **Louis Barinaga**, Snohomish, WA (US);
Gregory Coomer, Seattle, WA (US);
Claire Gottschalk, Bellevue, WA (US);
Eric Hope, Duvall, WA (US); **Quentin Smith**, Seattle, WA (US)

5,914,707	A *	6/1999	Kono	345/173
6,908,387	B2 *	6/2005	Hedrick et al.	463/31
6,930,600	B1 *	8/2005	Hsieh	340/539.1
6,941,181	B1 *	9/2005	Mathurin	700/94
7,098,582	B2 *	8/2006	Kim	313/402
D647,918	S *	11/2011	Ledbetter et al.	D14/496
D680,174	S *	4/2013	Mercier et al.	D21/333
D700,246	S *	2/2014	Jacobs et al.	D21/332
D705,869	S *	5/2014	Jacobs et al.	D21/332
D709,133	S *	7/2014	Jacobs et al.	D21/332
D709,134	S *	7/2014	Dallmeyer et al.	D21/332
D709,959	S *	7/2014	Jacobs et al.	D21/332

(73) Assignee: **Valve Corporation**, Bellevue, WA (US)

(*) Notice: This patent is subject to a terminal disclaimer.

* cited by examiner

(**) Term: **14 Years**

Primary Examiner — Prabhakar Deshmukh

(21) Appl. No.: **29/471,472**

(74) *Attorney, Agent, or Firm* — Barcelo, Harrison & Walker, LLP

(22) Filed: **Oct. 31, 2013**

(57) **CLAIM**

(51) **LOC (10) Cl.** **21-01**

The ornamental design for a game console, as shown and described.

(52) **U.S. Cl.**

DESCRIPTION

USPC **D21/332**

(58) **Field of Classification Search**

CPC A63F 9/00; A63F 9/24; A63F 11/00;
A63F 13/00; H04J 1/08; H04J 15/00; H04J
14/02; H04J 2203/0025
USPC D14/496, 401, 435, 474, 483, 217, 137,
D14/138, 160, 168, 356, 203.1–203.8, 507;
345/156, 169, 173–179, 905;
715/727–729, 864; 710/1, 5, 8; 713/1,
713/600; 455/1.1, 1.7, 73, 344–347, 93, 95,
455/3.01–3.06, 550.1, 573.1; 370/342–344;
369/1, 2, 6–12; 463/43–47, 29–35;
273/148 B; D21/324–333

FIG. 1 is a perspective view of a game console showing our new design.

FIG. 2 is a front elevation thereof.

FIG. 3 is a rear elevation thereof.

FIG. 4 is a left side elevation thereof.

FIG. 5 is a right side elevation thereof.

FIG. 6 is a top plan view thereof; and,

FIG. 7 is a bottom plan view thereof.

The broken lines are included for the purpose of illustrating the unclaimed portions and form no part of the claimed design.

See application file for complete search history.

1 Claim, 7 Drawing Sheets

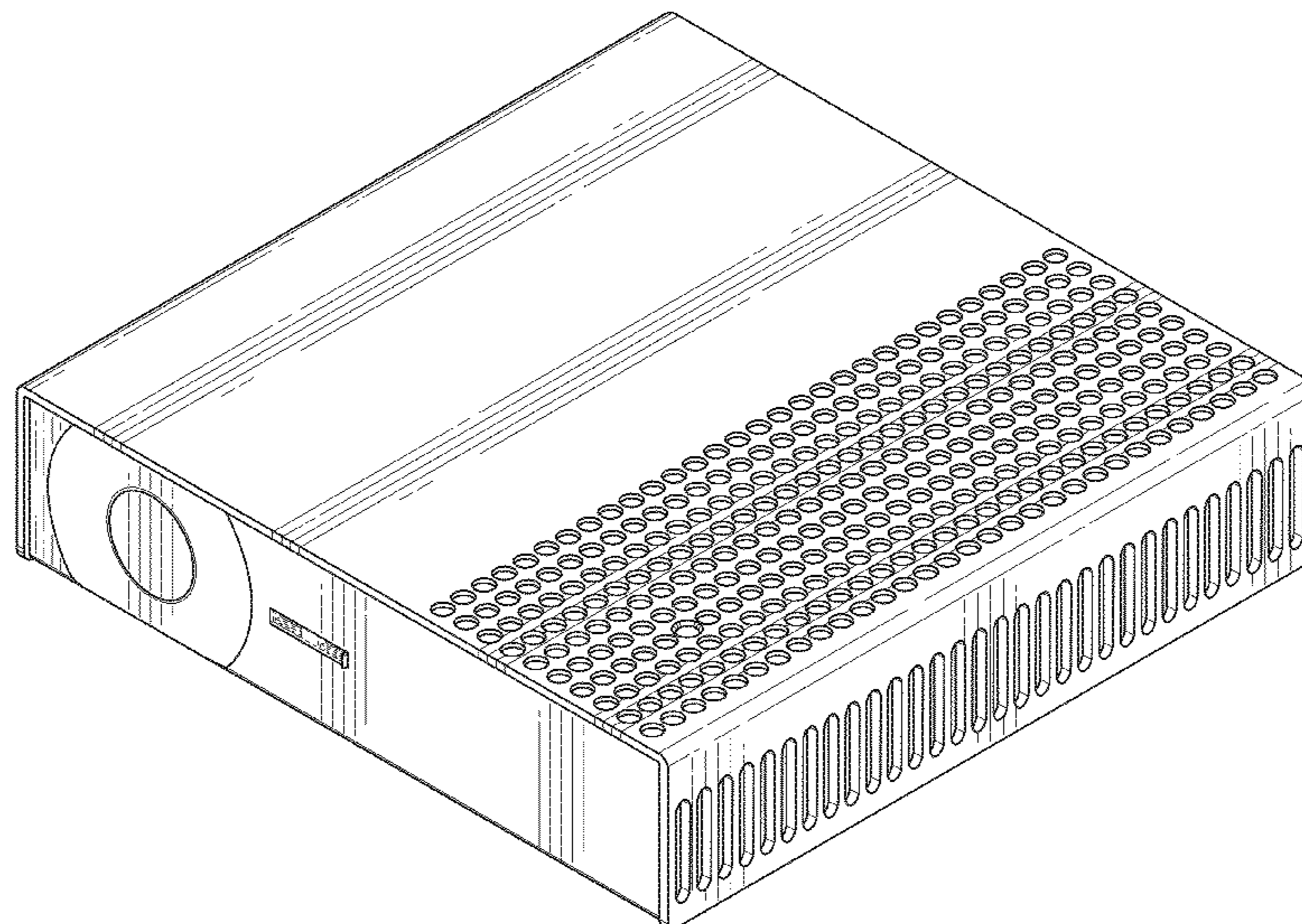

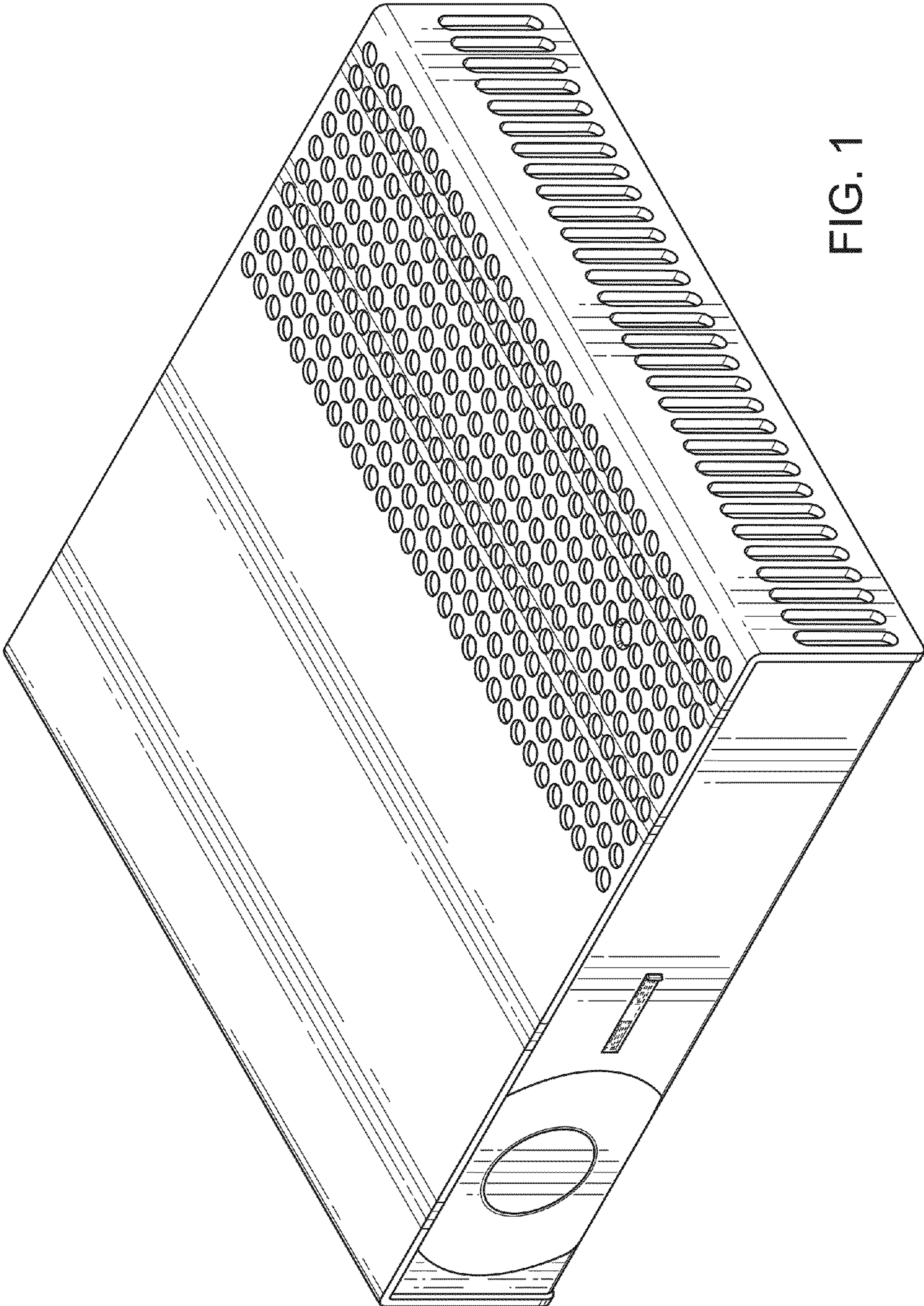

FIG. 1

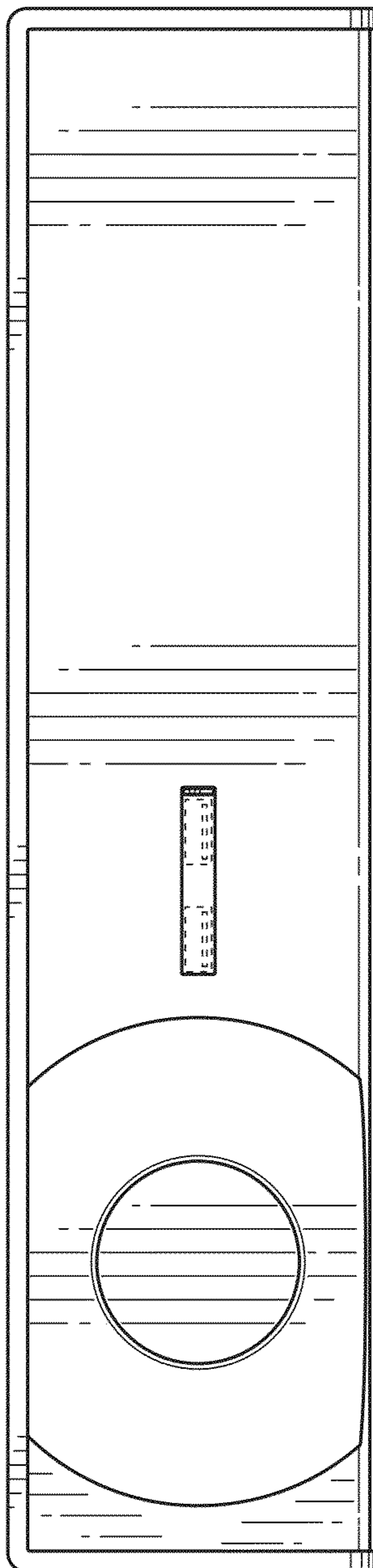

FIG. 2

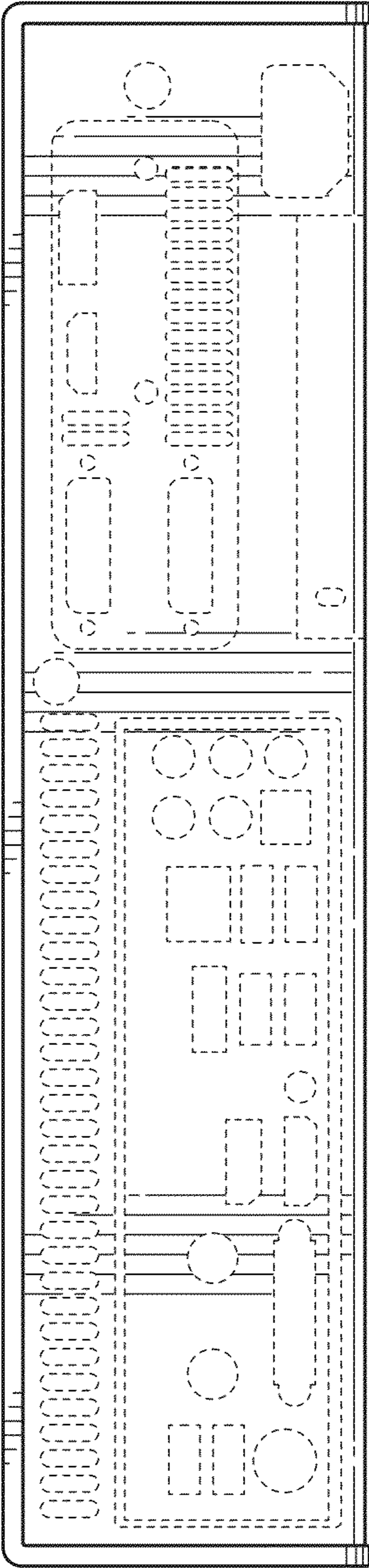

FIG. 3

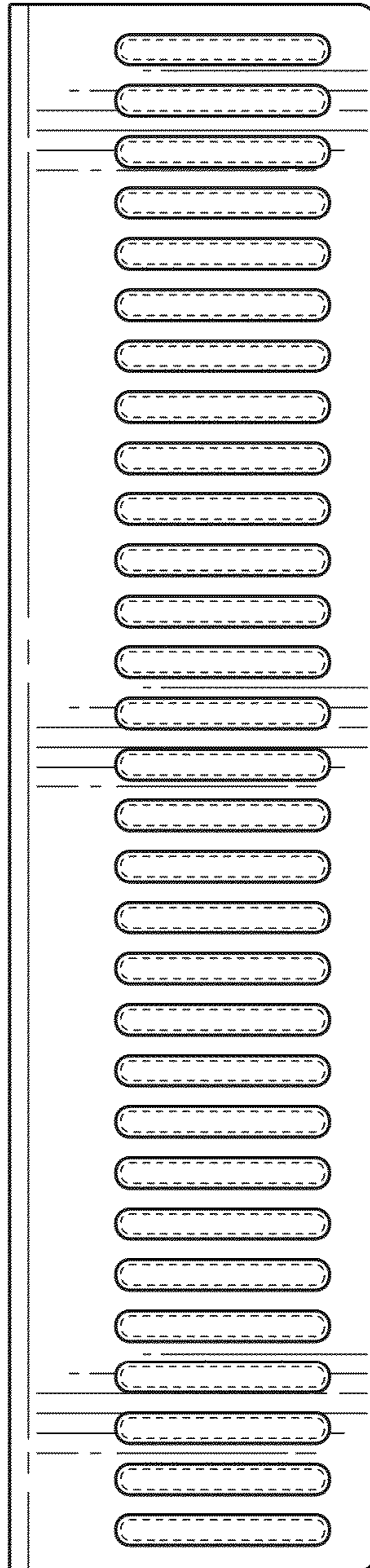

FIG. 4

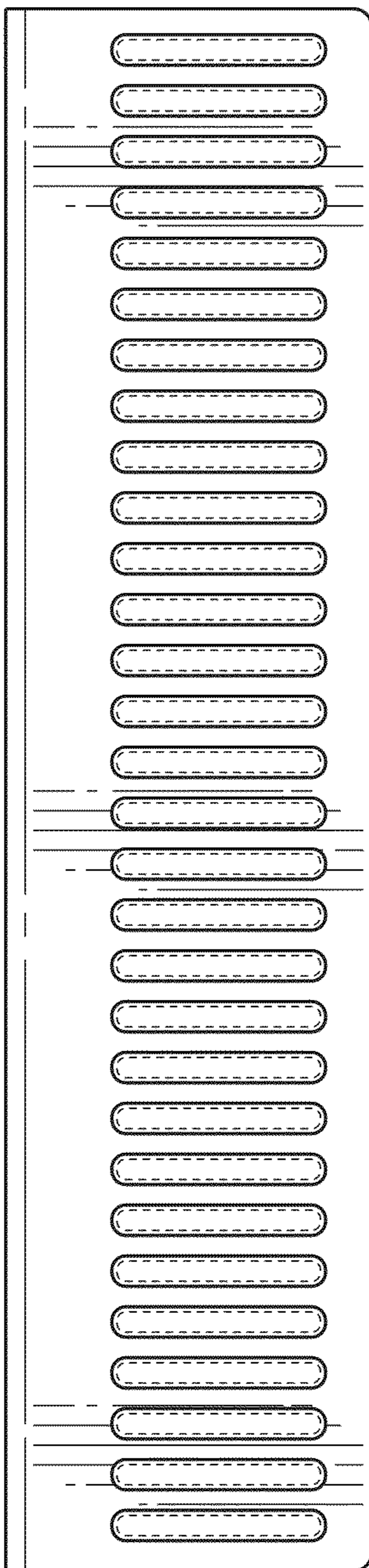

FIG. 5

FIG. 6

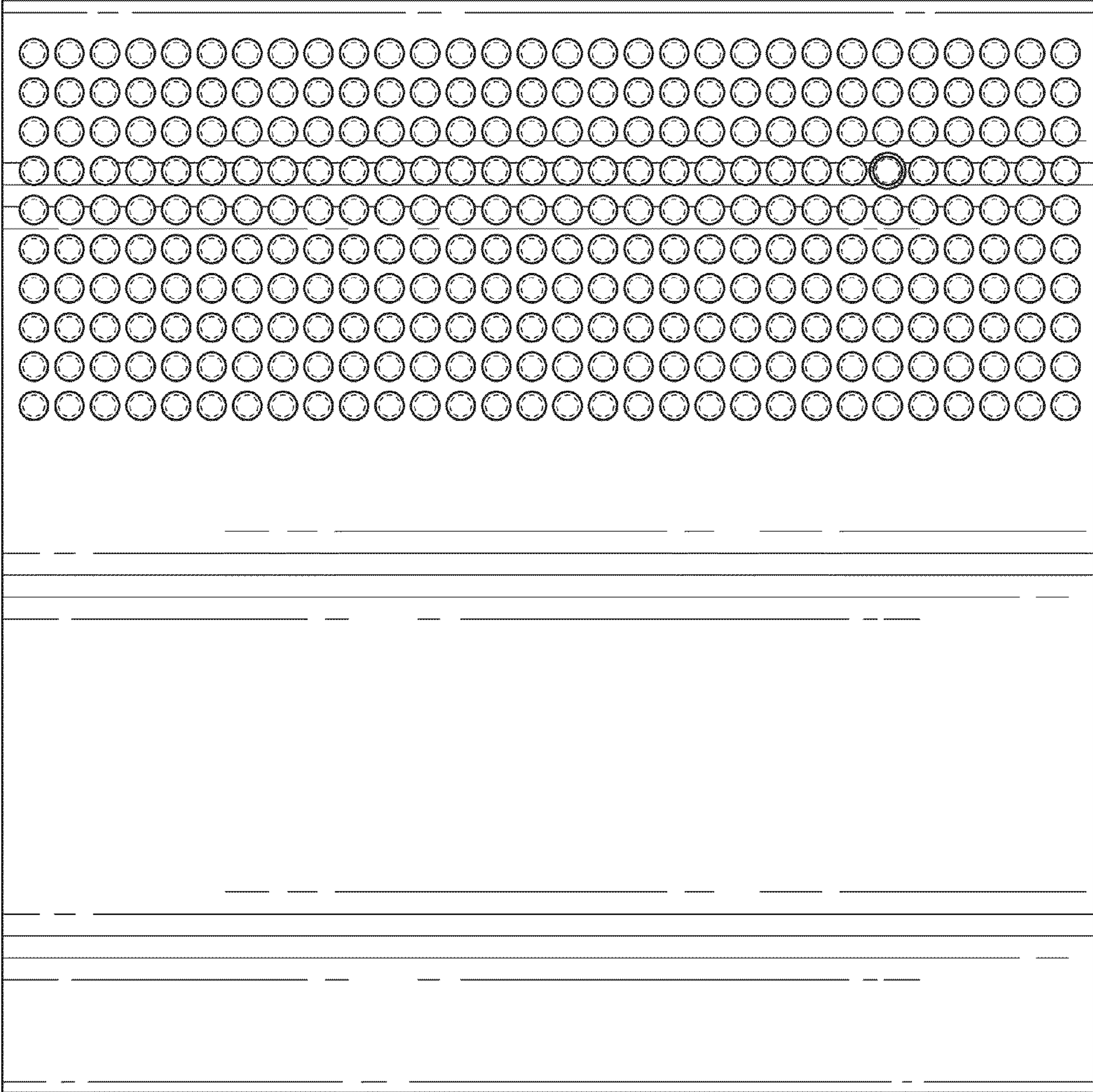

FIG. 7

