



US00D721077S

(12) **United States Design Patent**
Kim et al.

(10) **Patent No.:** **US D721,077 S**
(45) **Date of Patent:** **** Jan. 13, 2015**

(54) **KEYBOARD**

- (71) Applicant: **Samsung Electronics Co., Ltd.**,
Suwon-Si (KR)
- (72) Inventors: **Bong-Gun Kim**, Seocho-gu (KR);
Young-Geun Lim, Anyang-Si (KR);
Beom-Soo Bae, Anyang-Si (KR);
Hyun-Il Lee, Seocho-gu (KR)
- (73) Assignee: **Samsung Electronics Co., Ltd.**,
Suwon-Si (KR)
- (**) Term: **14 Years**
- (21) Appl. No.: **29/460,676**
- (22) Filed: **Jul. 12, 2013**
- (30) **Foreign Application Priority Data**

Jan. 30, 2013 (KR) 30-2013-0005121

(51) **LOC (10) Cl.** **14-02**

(52) **U.S. Cl.**
USPC **D14/392**

(58) **Field of Classification Search**
USPC D14/240, 391-399, 443, 455, 456, 433;
D18/1, 2, 7, 11; 178/17 A, 17 C;
200/5 A, 5 R, 6 A, 6 R; 235/145 A, 145 R;
341/20-23; 345/156, 160, 168, 169,
345/173, 700; 361/679.08, 679.09;
400/484-489, 492, 472
See application file for complete search history.

(56) **References Cited**

U.S. PATENT DOCUMENTS

D286,047 S	10/1986	Roots et al.
D301,037 S	5/1989	Matsuda
D308,855 S	6/1990	Schaum
D310,219 S	8/1990	Carlile
D327,881 S	7/1992	McFarlane
D329,848 S	9/1992	Mizusugi et al.
5,267,123 A	11/1993	Boothroyd et al.
D350,747 S	9/1994	McClendon

(Continued)

FOREIGN PATENT DOCUMENTS

KE	3002861330000	10/2001
KR	3002119350000	12/1997

(Continued)

OTHER PUBLICATIONS

U.S. Appl. No. 29/390,398, Applicant Dae-Joun Kim et al., filed Apr. 25, 2011, entitled Wireless Keyboard.

(Continued)

Primary Examiner — Freda S Nunn

(74) *Attorney, Agent, or Firm* — Wood, Herron & Evans, LLP

(57) **CLAIM**

The ornamental design for a keyboard, as shown and described.

DESCRIPTION

FIG. 1 is a top front perspective view of a keyboard showing our new design;
 FIG. 2 is a top view thereof;
 FIG. 3 is a bottom view thereof;
 FIG. 4 is a left side view thereof;
 FIG. 5 is a right side view thereof;
 FIG. 6 is a front view thereof;
 FIG. 7 is a rear view thereof;
 FIG. 8 is an enlarged detail view of the portion A encircled in FIG. 2;
 FIG. 9 is a cross-sectional view thereof taken along line 9-9 in FIG. 8; and,
 FIG. 10 is another front view thereof being mounted on a portable computer.
 The broken lines illustrating portions of the keyboard are for environmental purposes only and form no part of the claimed design.

1 Claim, 5 Drawing Sheets

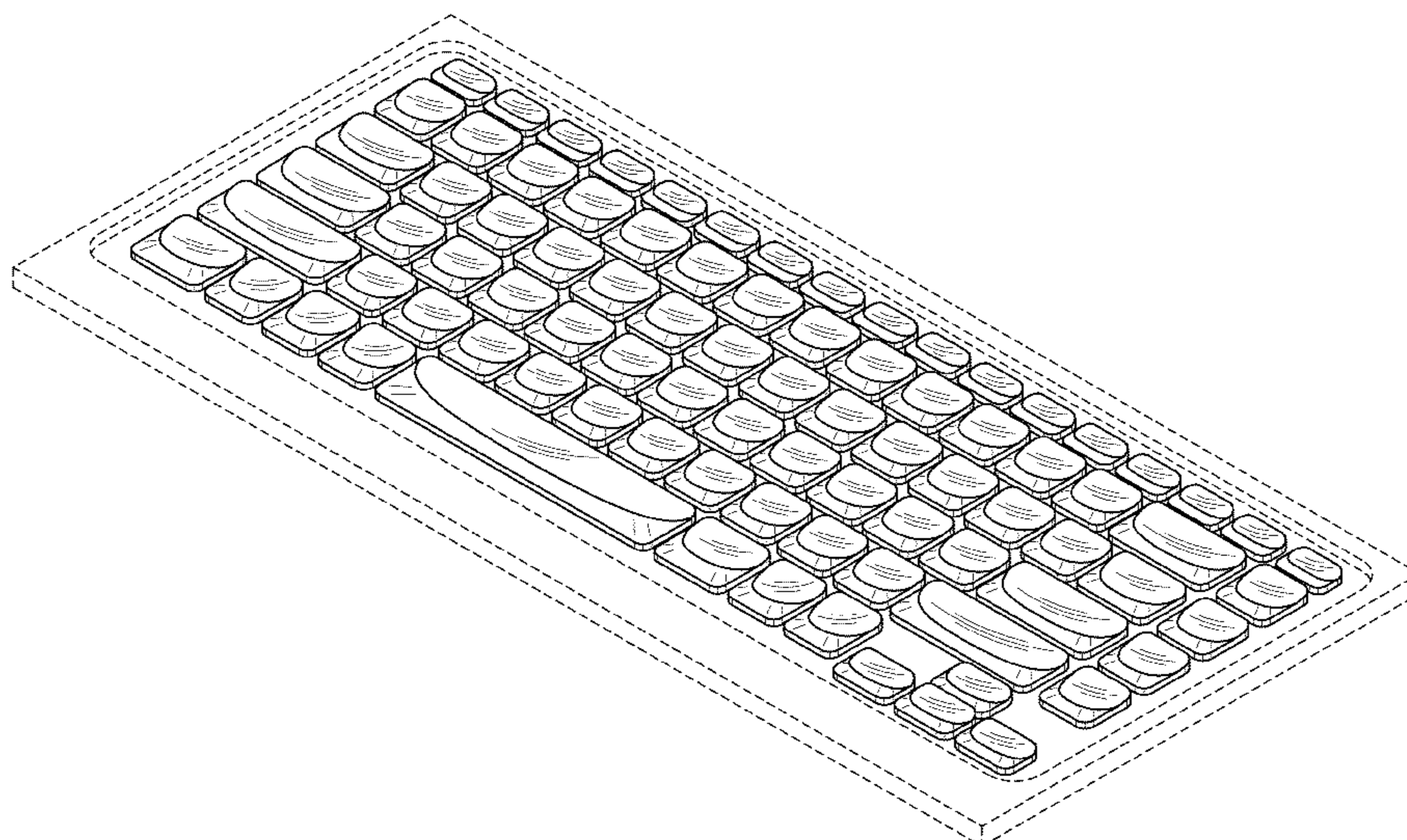

(56)

References Cited

U.S. PATENT DOCUMENTS

5,439,304 A 8/1995 Phillips et al.
 5,887,723 A 3/1999 Myles et al.
 D440,566 S 4/2001 Chou
 D445,793 S 7/2001 Ji
 D466,898 S 12/2002 Hoornaert et al.
 D470,150 S * 2/2003 Lewis et al. D14/455
 D491,562 S * 6/2004 Chou D14/396
 6,829,140 B2 12/2004 Shimano et al.
 D501,478 S 2/2005 Tzeng et al.
 D518,053 S 3/2006 Chen
 D521,986 S 5/2006 Depay et al.
 D534,900 S 1/2007 Weitgasser et al.
 D549,667 S 8/2007 Huang
 D549,710 S 8/2007 Hyneczek et al.
 7,254,012 B2 8/2007 Chou
 D563,407 S 3/2008 Jawerth et al.
 D565,048 S 3/2008 Jawerth et al.
 D565,578 S * 4/2008 Hofer et al. D14/455
 D592,212 S 5/2009 Hamada et al.
 D598,451 S 8/2009 Andre et al.
 D601,148 S 9/2009 Akita
 D606,073 S 12/2009 O'Neil et al.
 D606,539 S 12/2009 Liao et al.
 D606,961 S 12/2009 Aarras
 D616,440 S 5/2010 Lee
 D616,886 S 6/2010 Andre et al.
 D622,723 S * 8/2010 Rak et al. D14/391
 D628,998 S 12/2010 Wu et al.
 D630,751 S 1/2011 Yanase et al.
 D633,498 S 3/2011 Andre et al.
 D638,392 S 5/2011 Price et al.
 7,986,983 B2 7/2011 Harmon et al.
 D652,833 S 1/2012 Kim et al.
 D659,139 S 5/2012 Gengler
 D665,803 S 8/2012 Knighton
 D671,120 S 11/2012 Kim
 D678,280 S 3/2013 Choi et al.
 D678,883 S 3/2013 Lim et al.
 2002/0044814 A1 4/2002 King et al.
 2003/0048595 A1 3/2003 Hsieh et al.
 2003/0078069 A1 4/2003 Lindeman
 2008/0270897 A1 10/2008 Jawerth et al.
 2009/0135554 A1 * 5/2009 Chien et al. 361/679.08

2010/0149741 A1 6/2010 Liu
 2011/0294555 A1 12/2011 Happonen et al.
 2012/0092195 A1 4/2012 Lin

FOREIGN PATENT DOCUMENTS

KR 3002119350001 12/1997
 KR 3004375080000 12/1997
 KR 3002163470000 2/1998
 KR 3002163540000 2/1998
 KR 3002194830000 4/1998
 KR 3002194840000 4/1998
 KR 3002212020000 5/1998
 KR 3002817600000 8/2001
 KR 3002912170000 2/2002
 KR 3003079740000 9/2002
 KR 3003160270000 1/2003
 KR 3003776380000 3/2005
 KR 3006036150000 6/2011

OTHER PUBLICATIONS

U.S. Appl. No. 29/390,422, Applicant Dae-Joun Kim et al., filed Apr. 25, 2011, entitled Wireless Keyboard.
 U.S. Appl. No. 29/405,575, Applicant Ik-Sang Kim, filed Nov. 3, 2011, entitled Wireless Keyboard.
 U.S. Appl. No. 29/423,293, Applicant Su-An Choi et al., filed May 30, 2012, entitled Wireless Keyboard.
 U.S. Appl. No. 29/425,979, Applicant Woo-Teik Lim et al., filed Jun. 28, 2012, entitled Keyboard for a Tablet Computer.
 U.S. Appl. No. 29/426,585, Applicant Ji-Sang Park, filed Jul. 6, 2012, entitled Keyboard for a Tablet Computer.
 U.S. Appl. No. 29/430,809, Applicant Su-An Choi et al., filed Aug. 30, 2012, entitled Wireless Keyboard.
 U.S. Appl. No. 29/438,938, Applicant Min-Young Park, filed Dec. 5, 2012, entitled Keyboard for Tablet Computer.
 U.S. Appl. No. 29/460,672, Applicant Bong-Gun Kim et al., filed Jul. 12, 2013, entitled Keyboard.
 U.S. Appl. No. 29/460,676, Applicant Bong-Gun Kim et al., filed Jul. 12, 2013, entitled Keyboard.
 U.S. Appl. No. 29/460,680, Applicant Hyun-Il Lee et al., filed Jul. 12, 2013, entitled Keyboard.
 U.S. Appl. No. 29/475,205, Applicant Min-Young Park et al., filed Dec. 1, 2013, entitled Keyboard for Tablet Computer.
 U.S. Appl. No. 29/452,598, Applicant Sang-In Lee et al., filed Apr. 18, 2013, entitled Docking Keyboard.

* cited by examiner

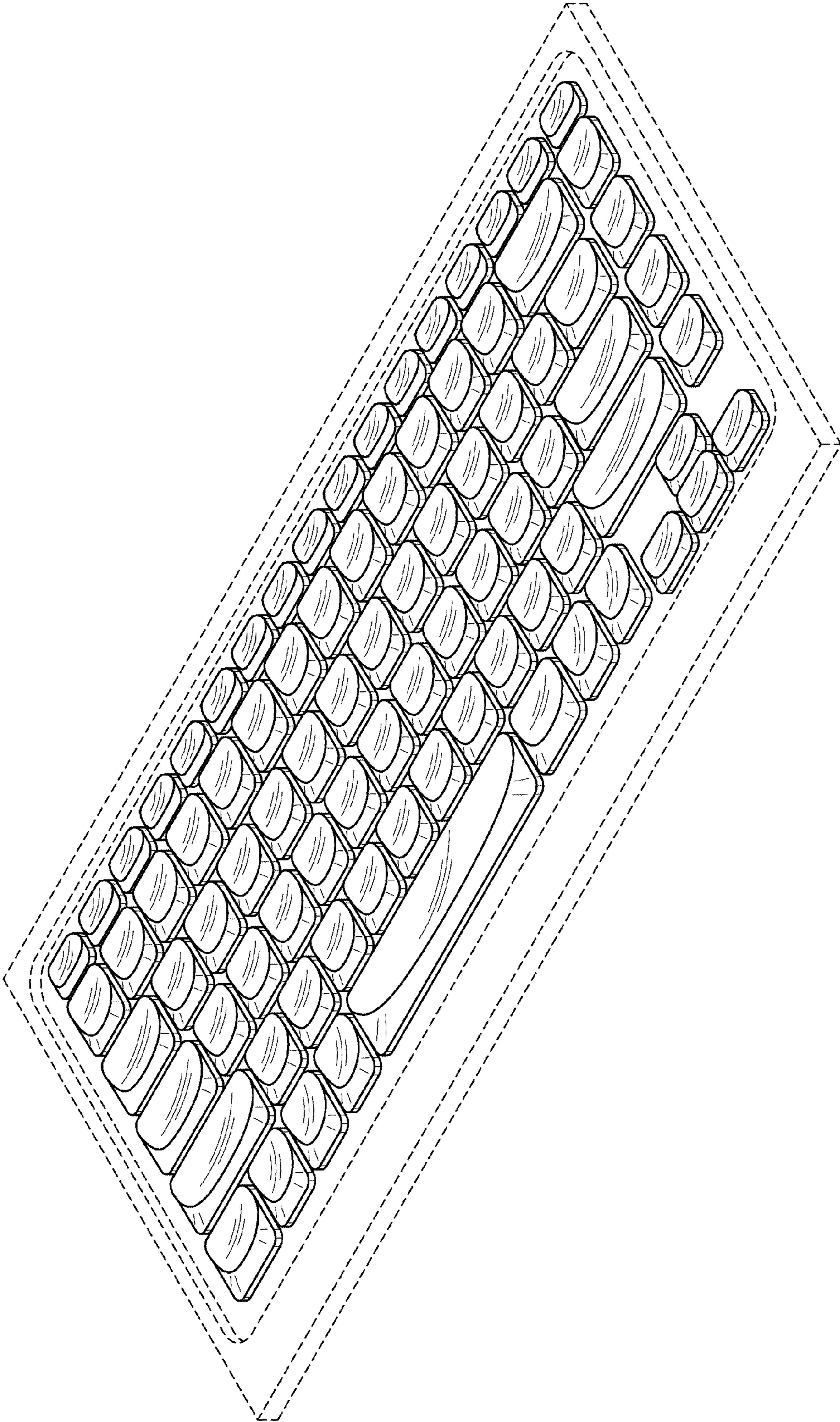

FIG.1

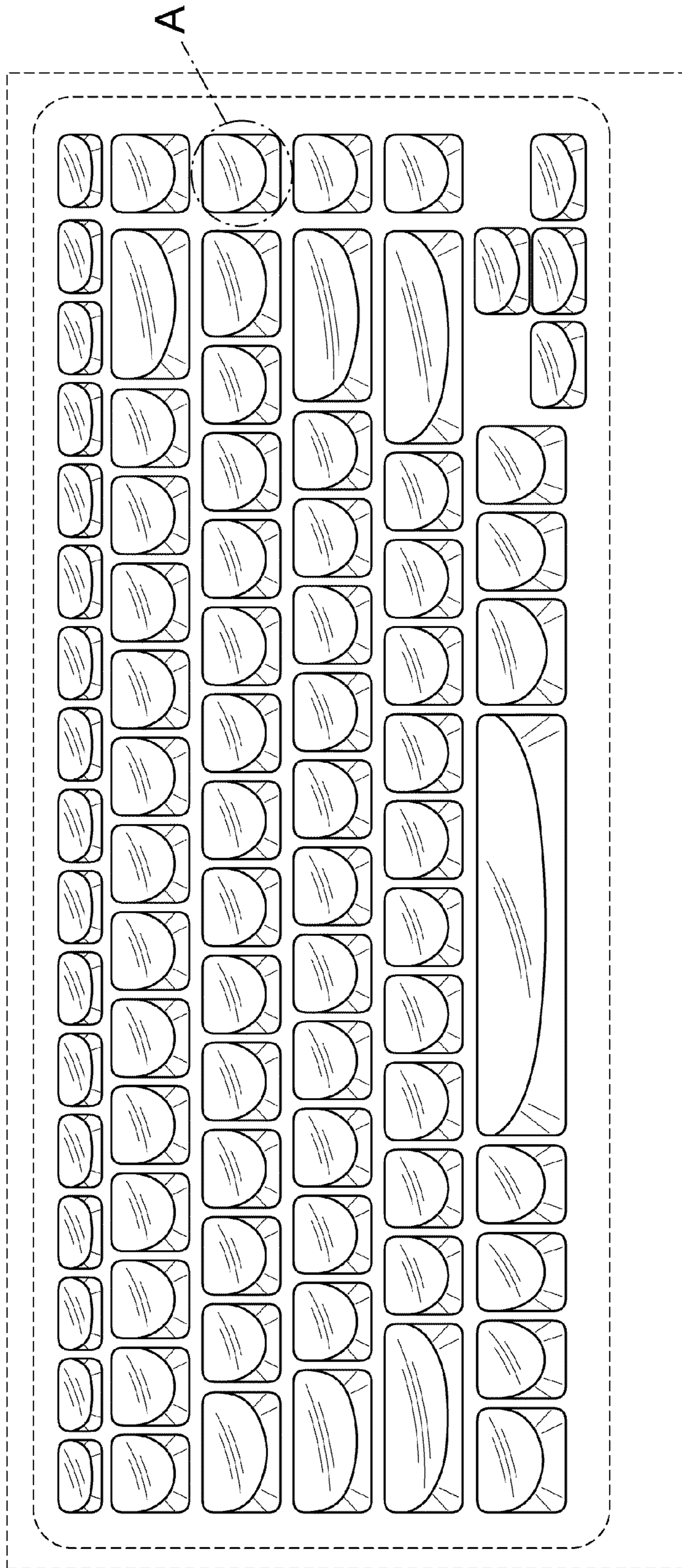

FIG. 2



FIG.3

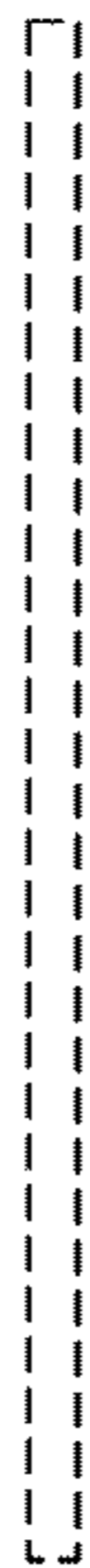

FIG.4



FIG.5

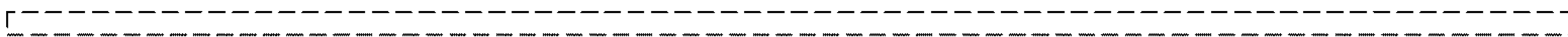

FIG.6

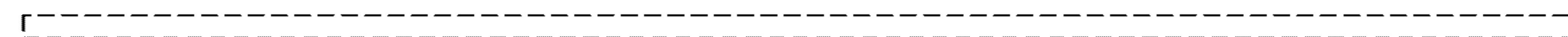

FIG.7

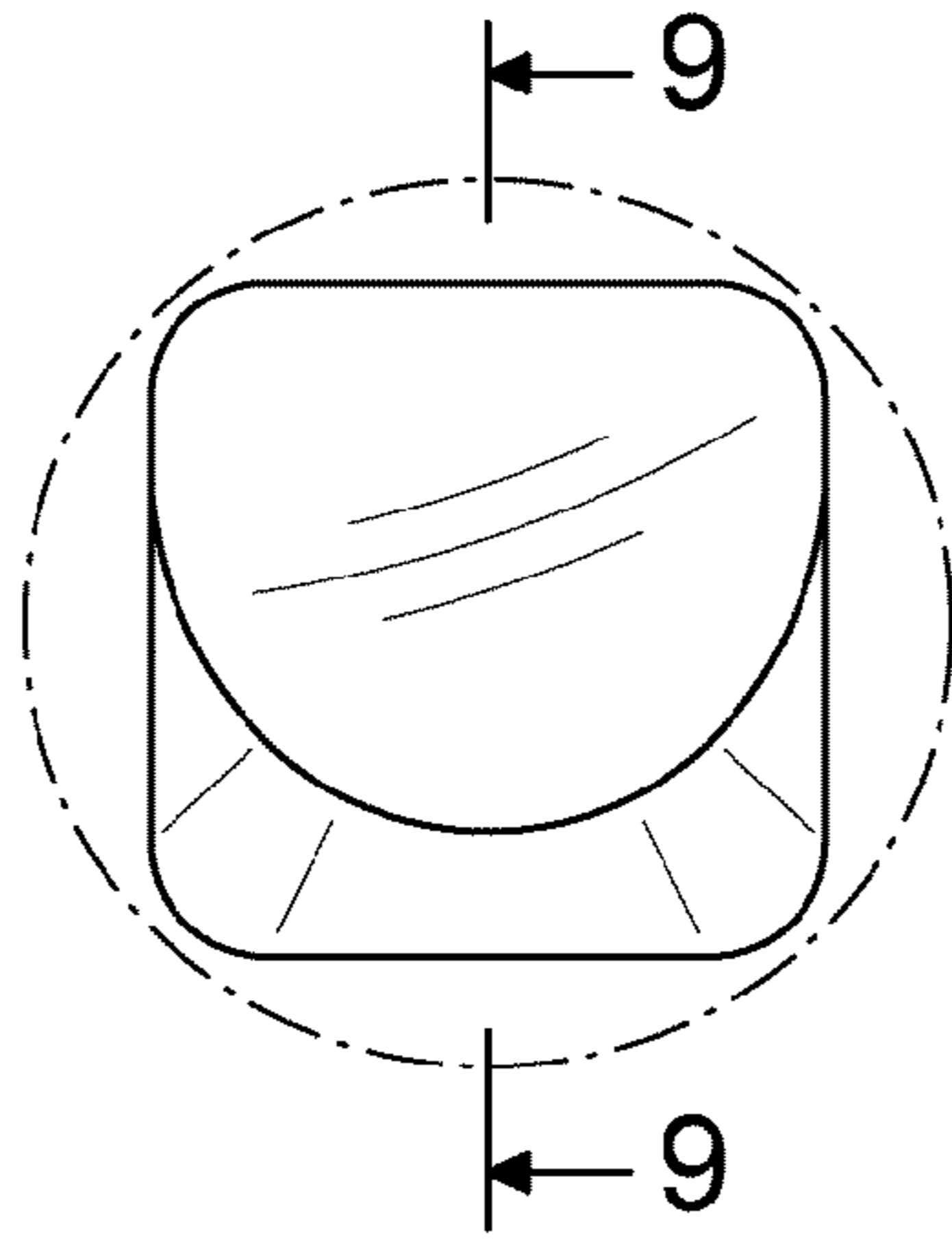

FIG. 8



FIG. 9

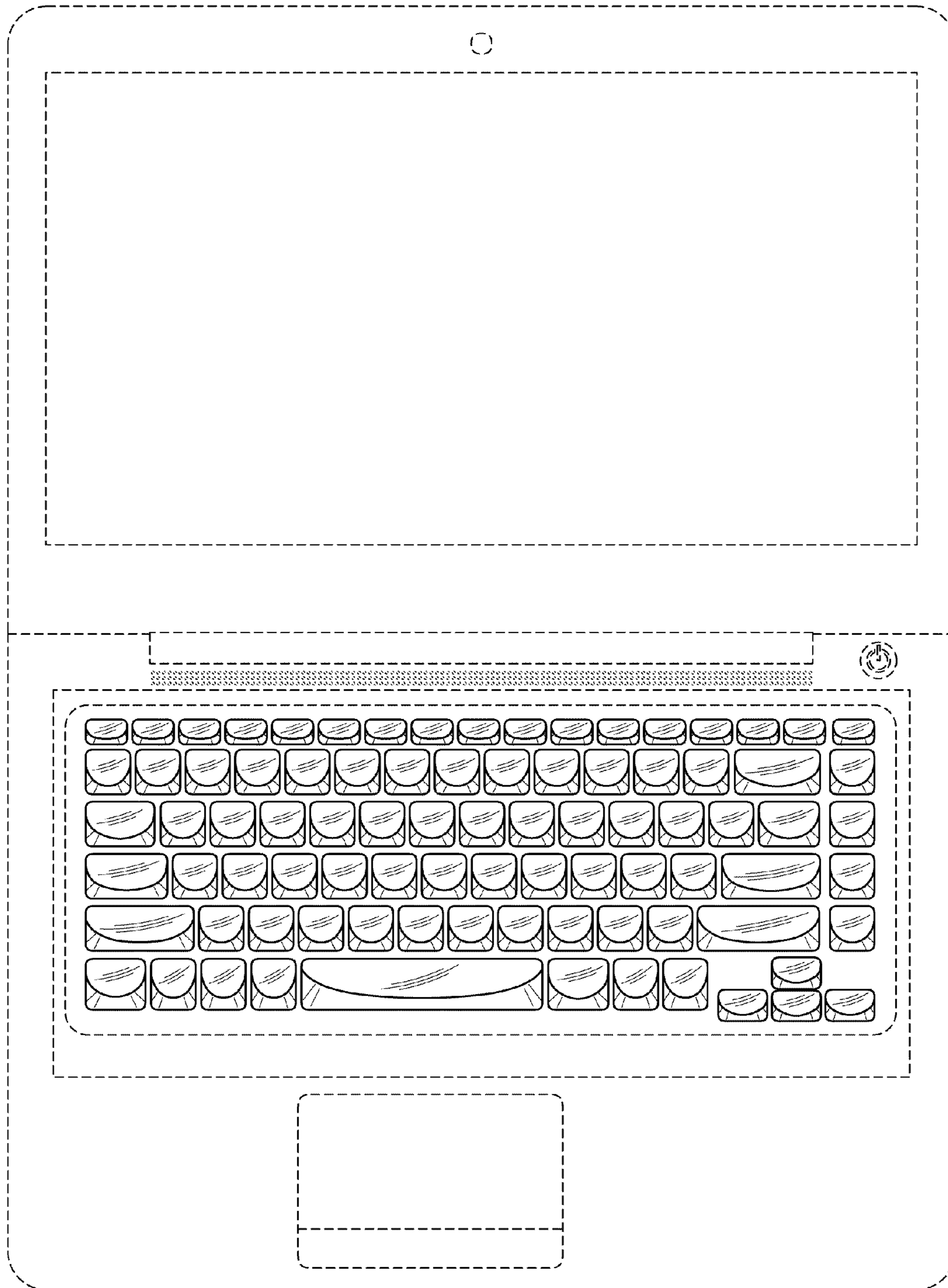

FIG.10