



US00D721029S

(12) **United States Design Patent**
Sato

(10) **Patent No.:** **US D721,029 S**
(45) **Date of Patent:** **** Jan. 13, 2015**

(54) **HOLE PLUG**

(75) Inventor: **Takehiro Sato**, Toyota (JP)

(73) Assignee: **Nifco Inc.**, Yokohama-Shi, Kanagawa (JP)

(**) Term: **14 Years**

(21) Appl. No.: **29/421,069**

(22) Filed: **May 15, 2012**

(30) **Foreign Application Priority Data**

Nov. 16, 2011 (JP) 2011-026474
Apr. 6, 2012 (JP) 2012-008177

(51) **LOC (10) Cl.** **12-16**

(52) **U.S. Cl.**
USPC **D12/400**

(58) **Field of Classification Search**
USPC D12/89, 190, 192, 195, 196, 203, 314,
D12/400, 401, 415; D28/36, 92; 280/5.3,
280/163, 164.2, 166, 169, 291; 132/53,
132/201, 216, 218; 220/324, 787, 788, 789;
D8/14, 42, 331, 349, 352, 382, 386,
D8/397, 399

See application file for complete search history.

(56) **References Cited**

U.S. PATENT DOCUMENTS

4,583,654 A * 4/1986 Pufpaff et al. 220/789
4,646,932 A * 3/1987 Masler 220/789
5,199,285 A * 4/1993 Lin 70/220
D351,220 S * 10/1994 Barnes D23/260
5,435,159 A * 7/1995 Ramsauer 70/370
D414,694 S * 10/1999 Richter D9/439
D450,290 S * 11/2001 Schardt D12/213
D471,428 S * 3/2003 Mirick D8/331
D490,767 S * 6/2004 Nagasawa et al. D12/400
D512,627 S * 12/2005 Okada D8/343
7,347,655 B2 * 3/2008 Nagasawa et al. 411/508
D613,828 S * 4/2010 Kinchen D23/260

D623,049 S * 9/2010 Zeyfang D8/397
D624,485 S * 9/2010 Aoki D12/400
8,070,008 B2 * 12/2011 Janke 220/789
D652,782 S * 1/2012 Sato D12/400
8,371,789 B2 * 2/2013 Takita 220/787

(Continued)

Primary Examiner — Deanna L Pratt

Assistant Examiner — Natasha Vujcic

(74) *Attorney, Agent, or Firm* — Manabu Kanesaka

(57) **CLAIM**

The ornamental design for a hole plug, as shown and described.

DESCRIPTION

FIG. 1 is a perspective view from the plan side of a hole plug showing my new design;
FIG. 2 is a perspective view from the bottom side thereof;
FIG. 3 is a plan view thereof;
FIG. 4 is a bottom view thereof;
FIG. 5 is a front view thereof; a rear view being symmetrical to the front view;
FIG. 6 is a right side view thereof;
FIG. 7 is a left side view thereof;
FIG. 8 is a cross-sectional view thereof along the line 8-8 in FIG. 3;
FIG. 9 is a cross-sectional view thereof along the line 9-9 in FIG. 3;
FIG. 10 is a perspective view from the plan side of another hole plug showing my new design;
FIG. 11 is a perspective view from the bottom side thereof;
FIG. 12 is a plan view thereof;
FIG. 13 is a bottom view thereof;
FIG. 14 is a front view thereof; a rear view being symmetrical to the front view;
FIG. 15 is a right side view thereof;
FIG. 16 is a left side view thereof; and,
FIG. 17 is a cross-sectional view thereof along the line 17-17 in FIG. 12.

1 Claim, 8 Drawing Sheets

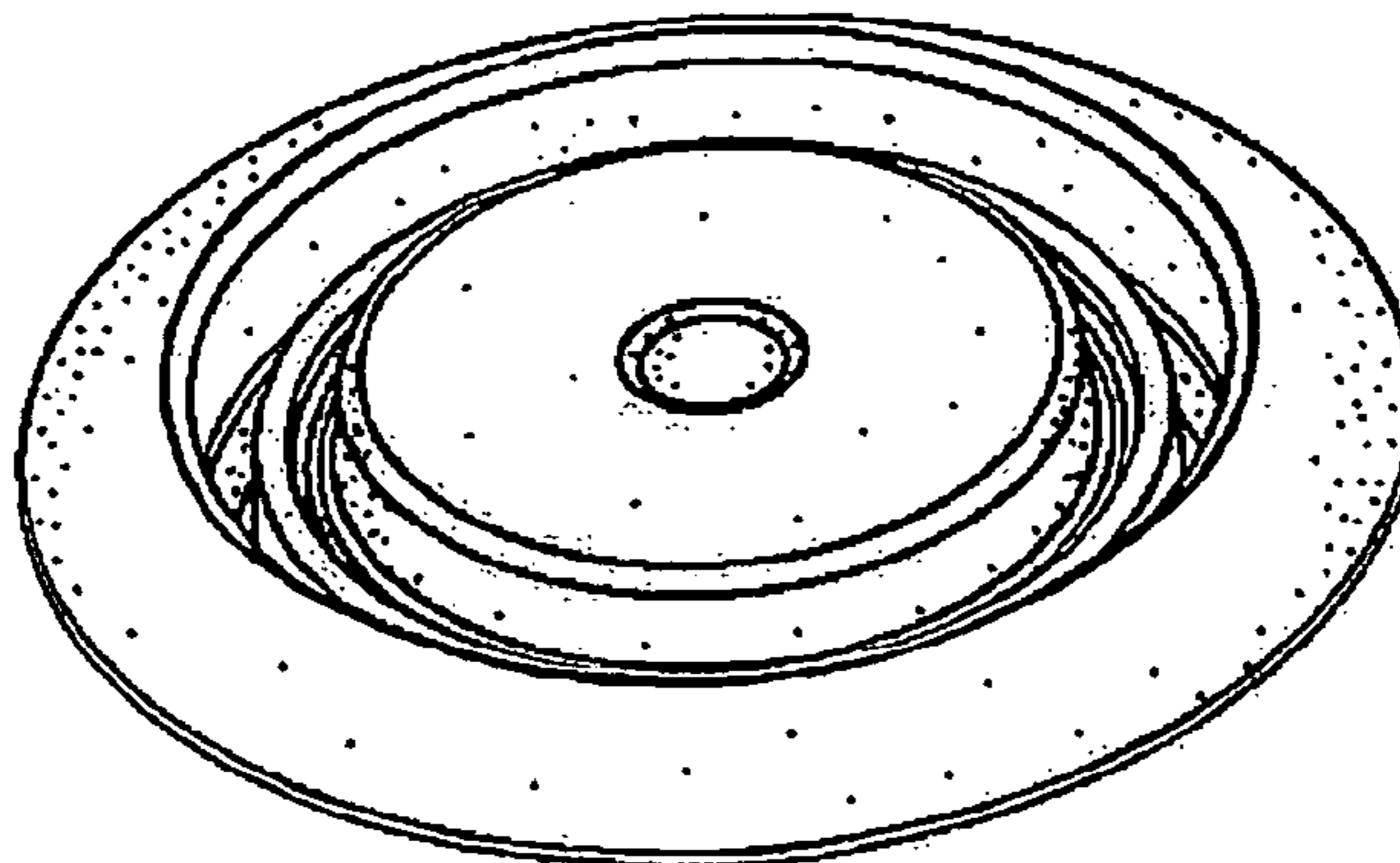

US D721,029 S

Page 2

(56)

References Cited

U.S. PATENT DOCUMENTS

2004/0091335 A1* 5/2004 Nagasawa et al. 411/508
2010/0018737 A1* 1/2010 Jackson et al. 174/50

2004/0083593 A1* 5/2004 Jackson et al. 29/456 * cited by examiner

FIG. 1

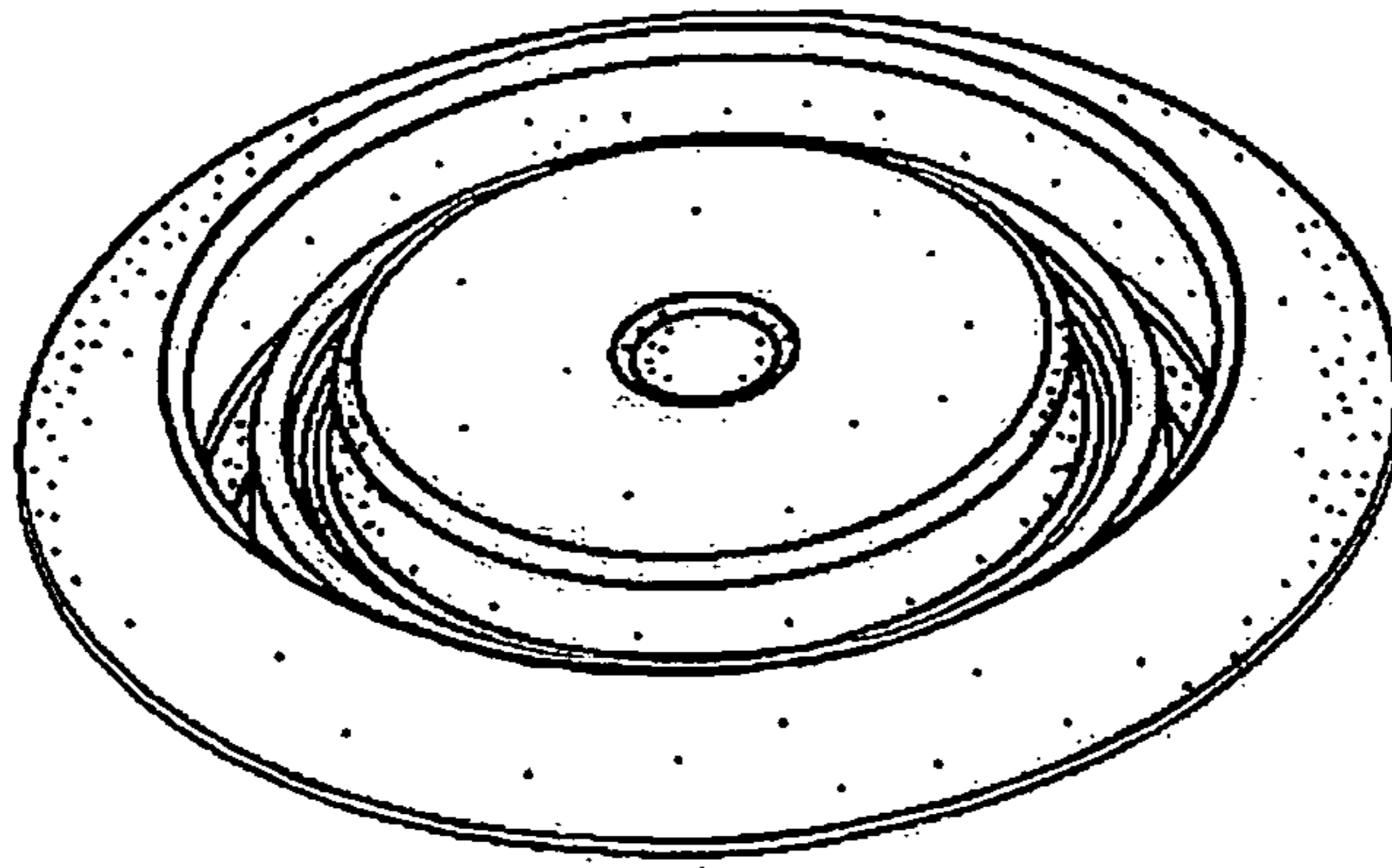

FIG. 2

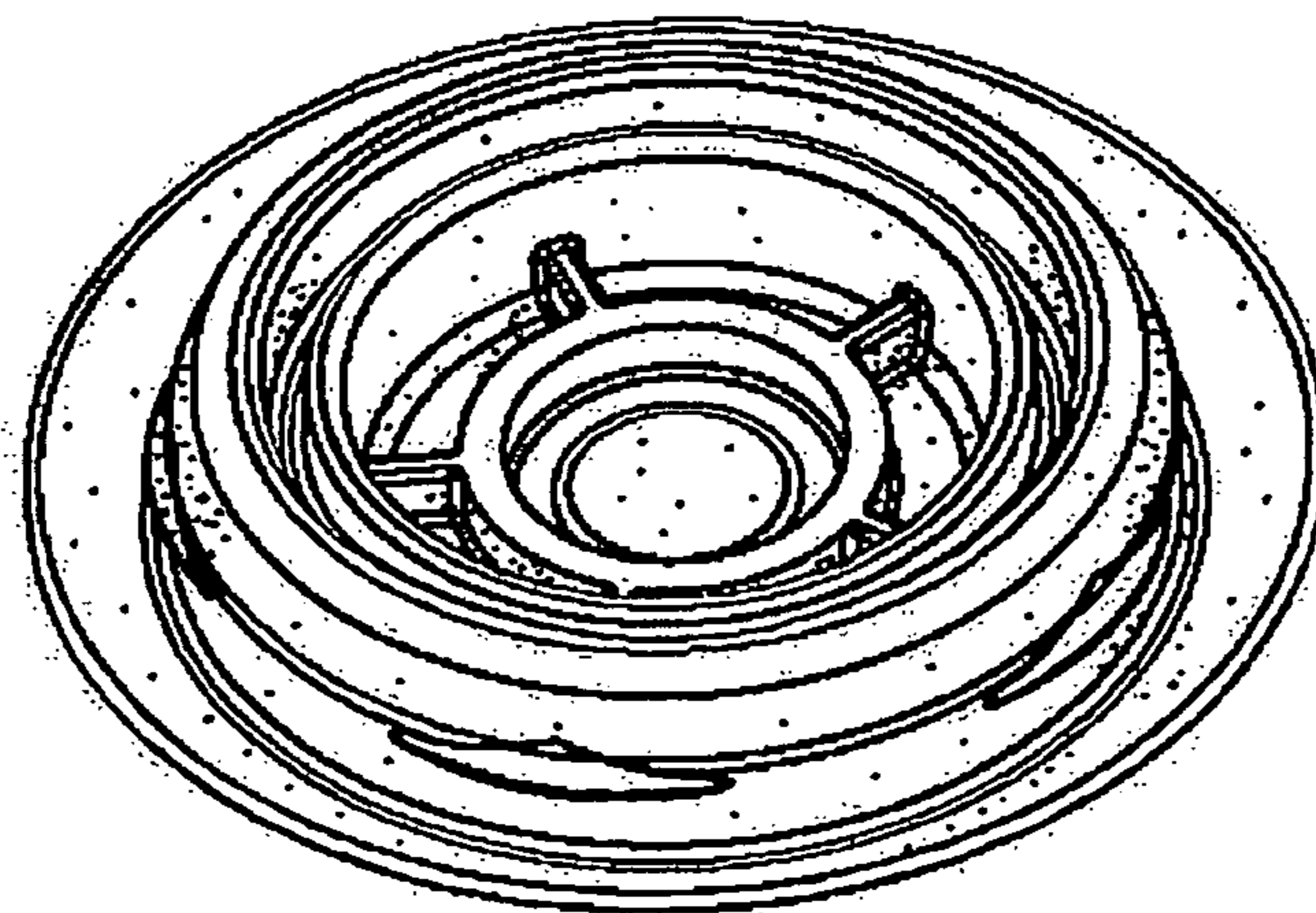

FIG. 3

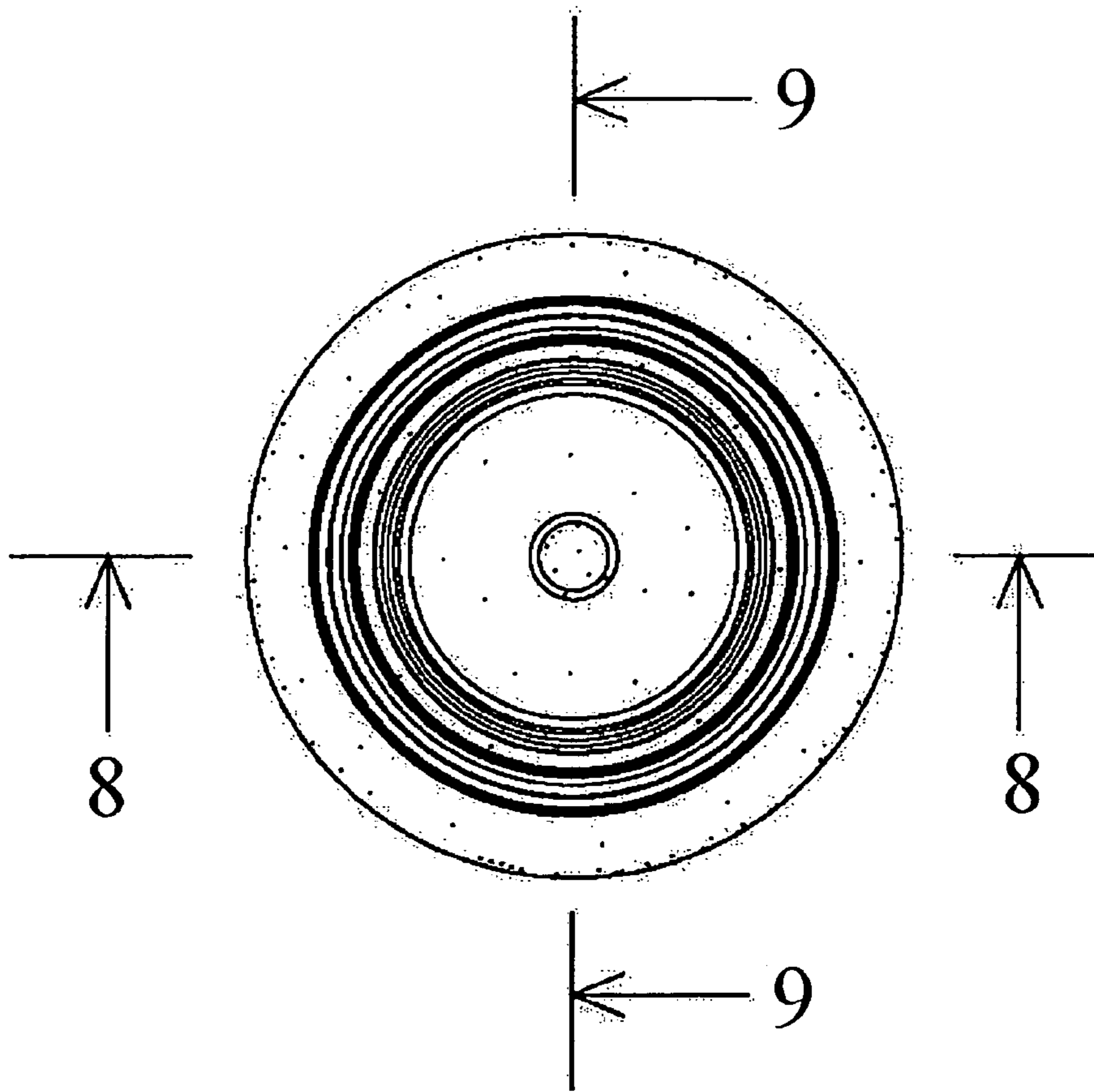

FIG. 4

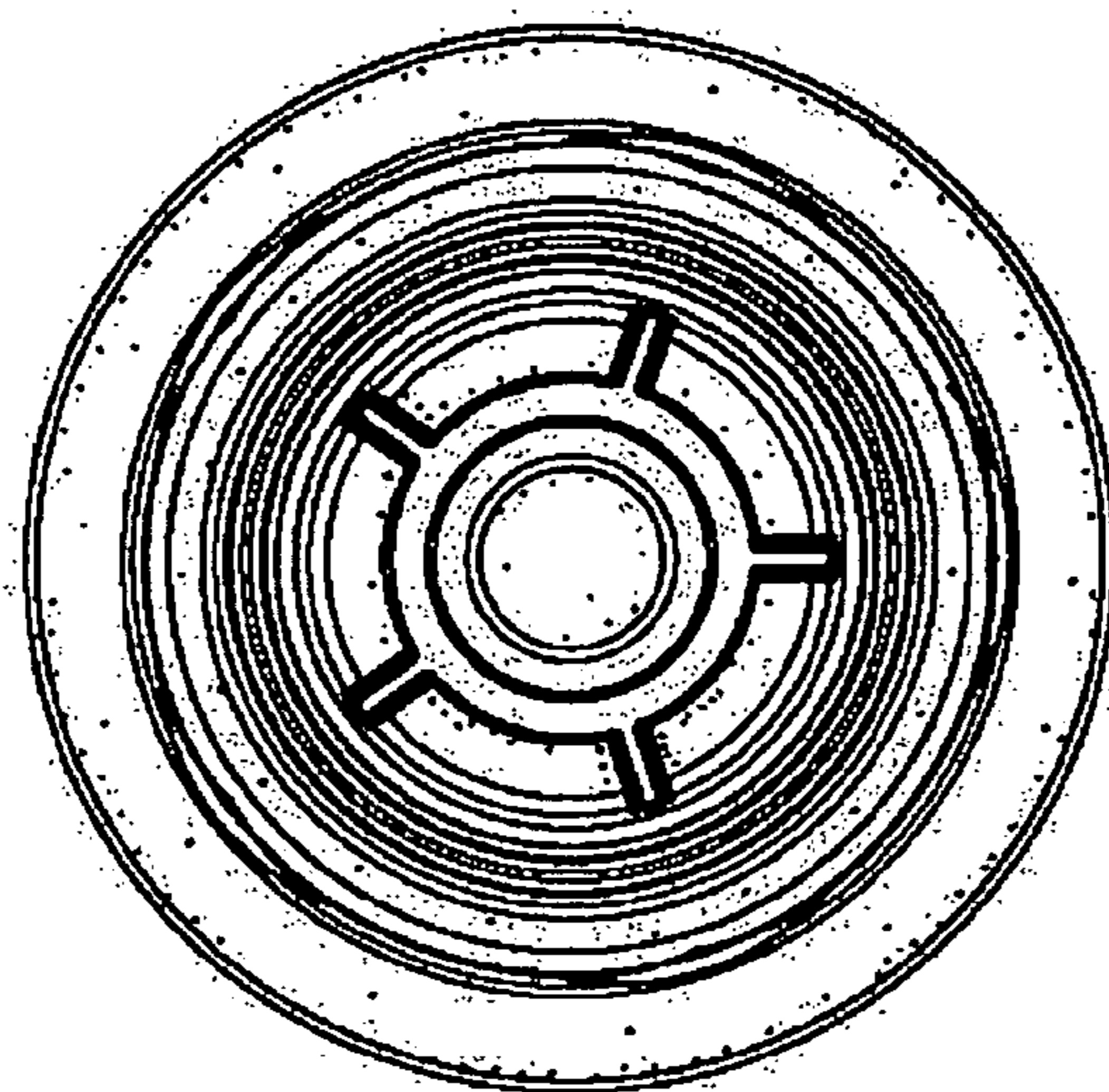

FIG. 5

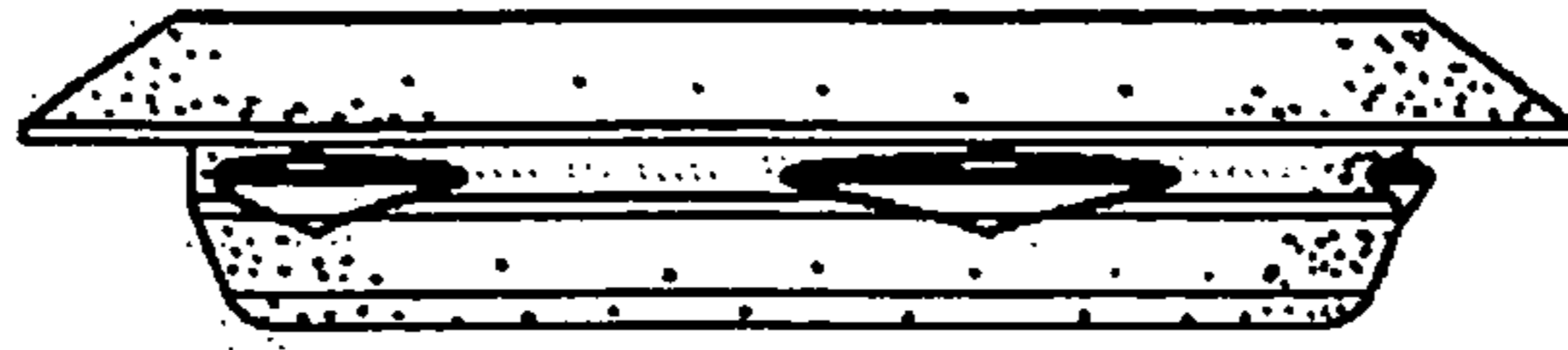

FIG. 6

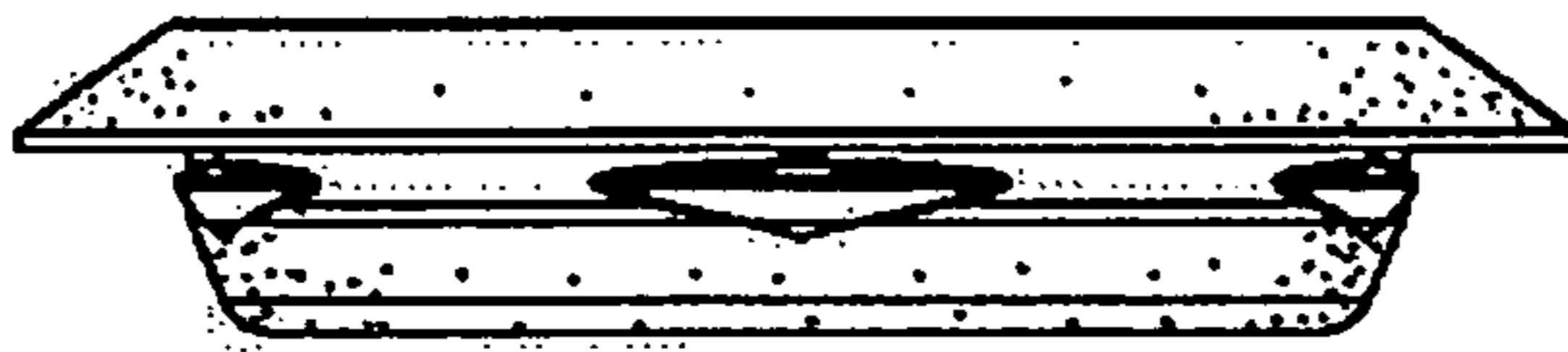

FIG. 7

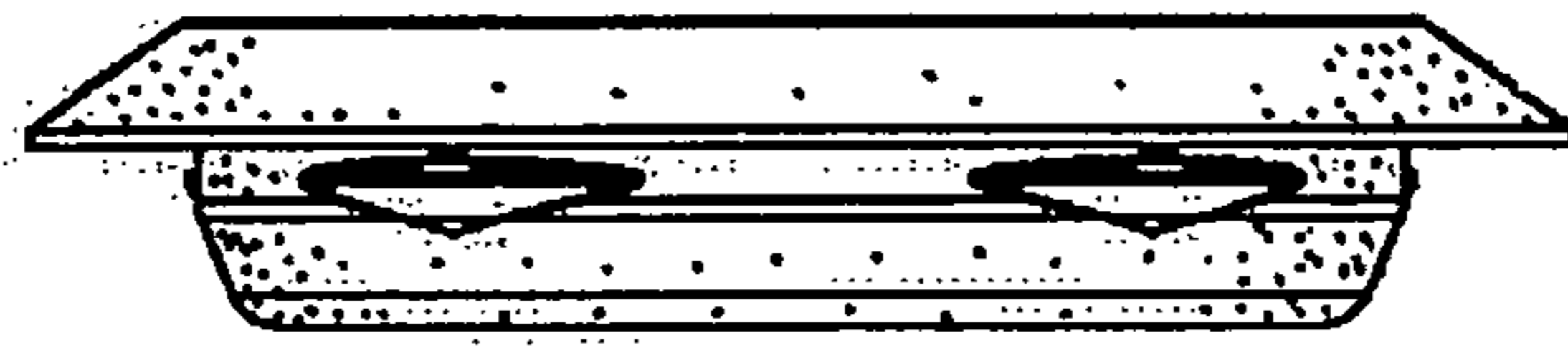

FIG. 8



FIG. 9



FIG. 10

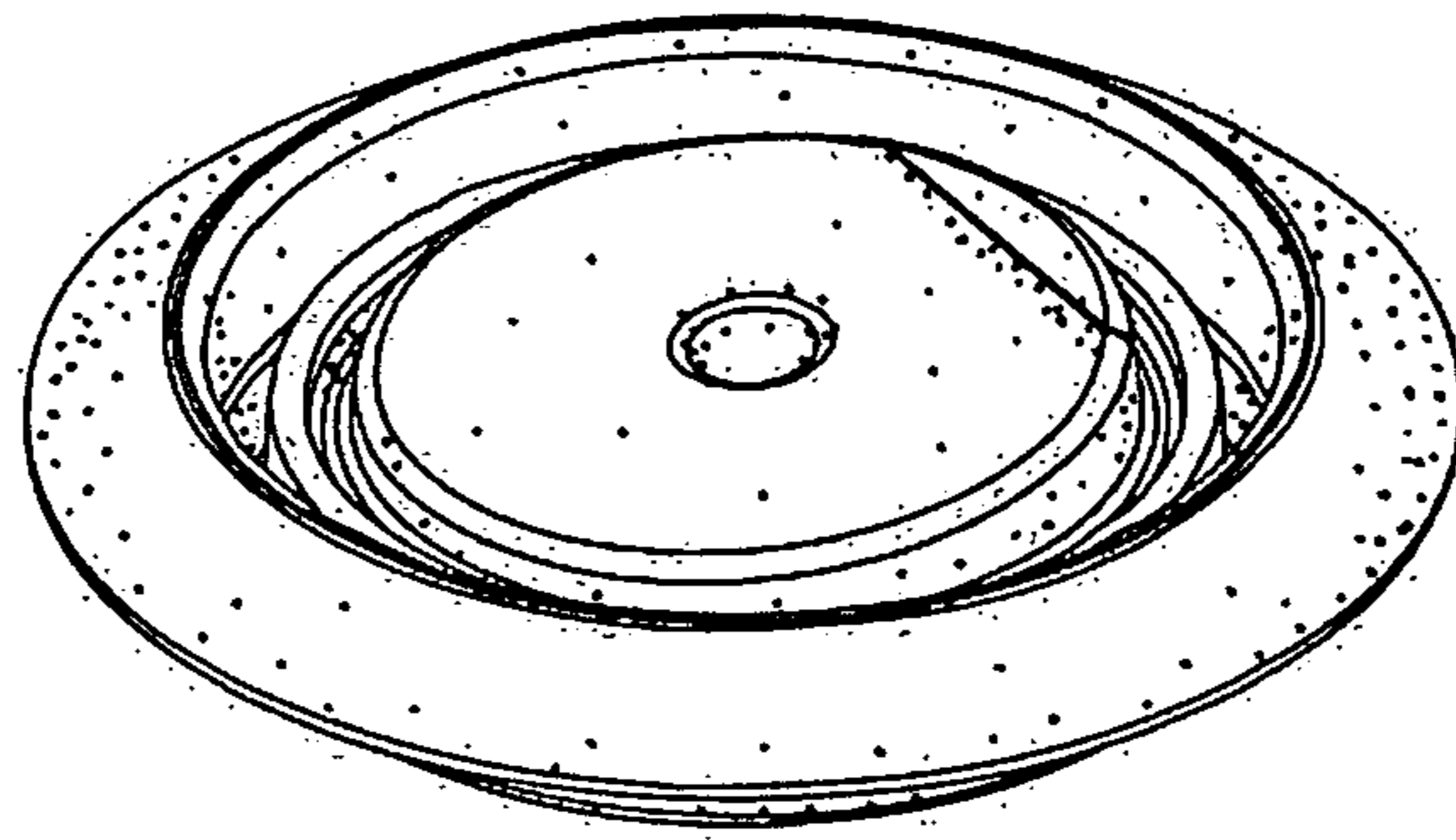

FIG. 11

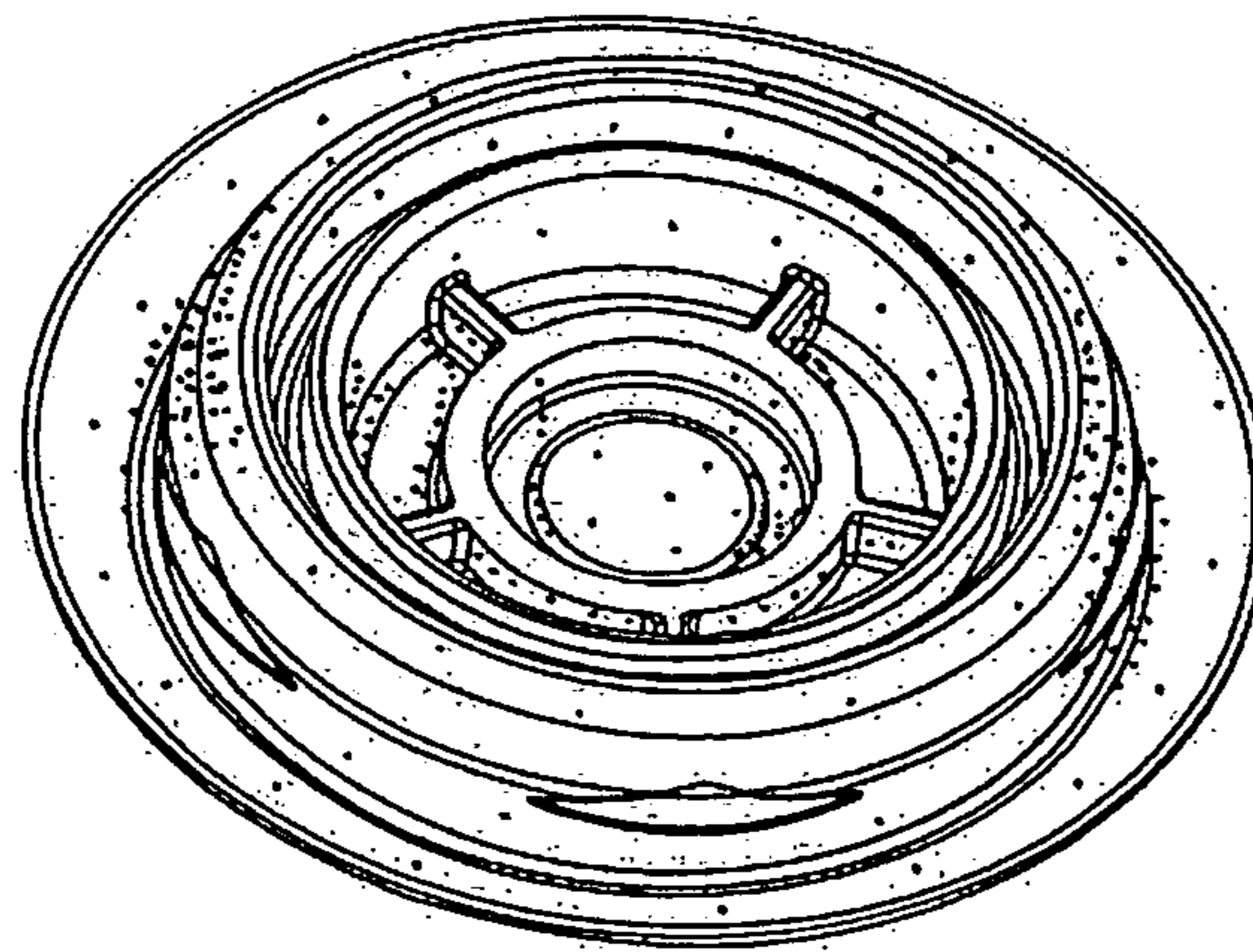

FIG. 12

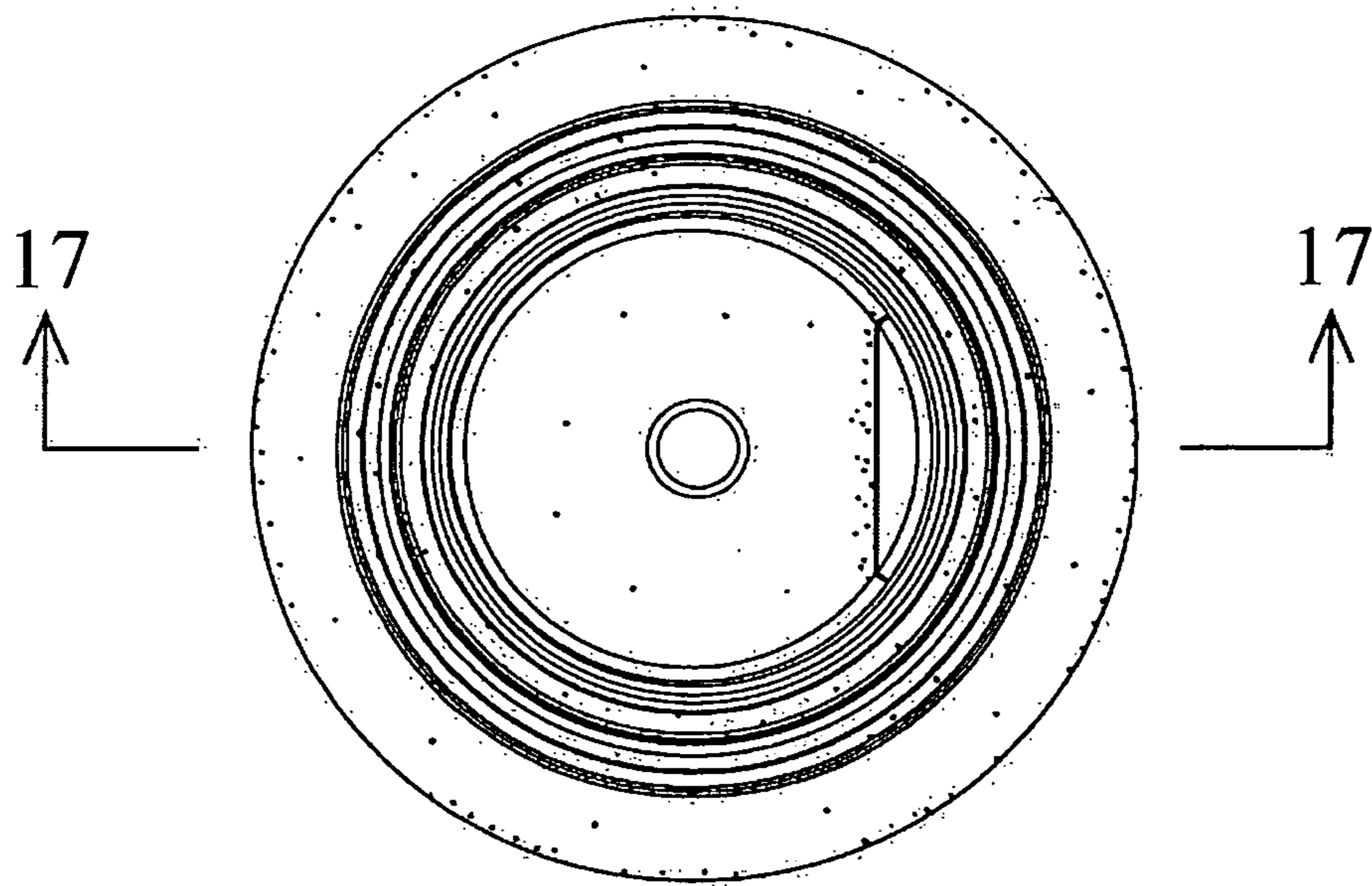

FIG. 13

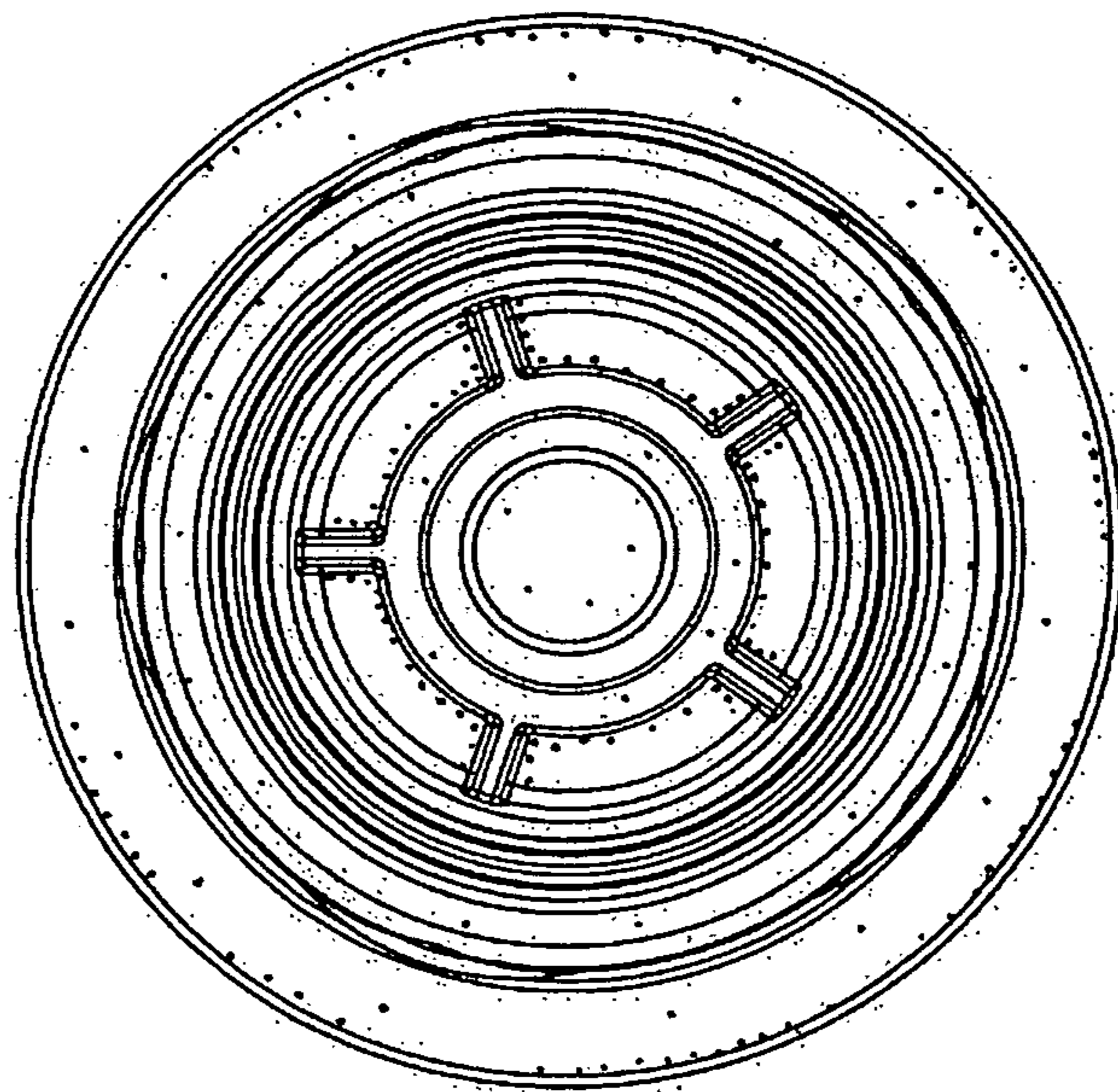

FIG. 14

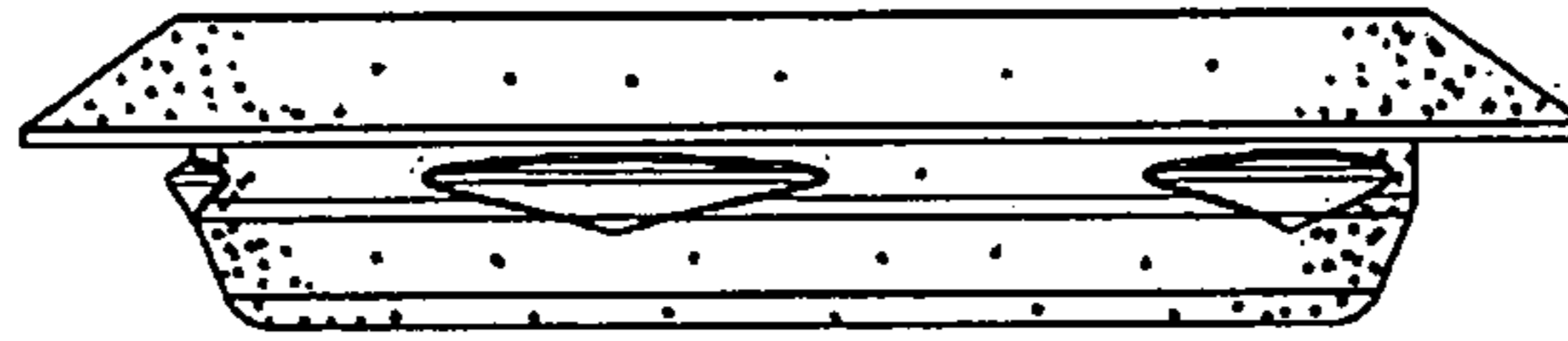

FIG. 15

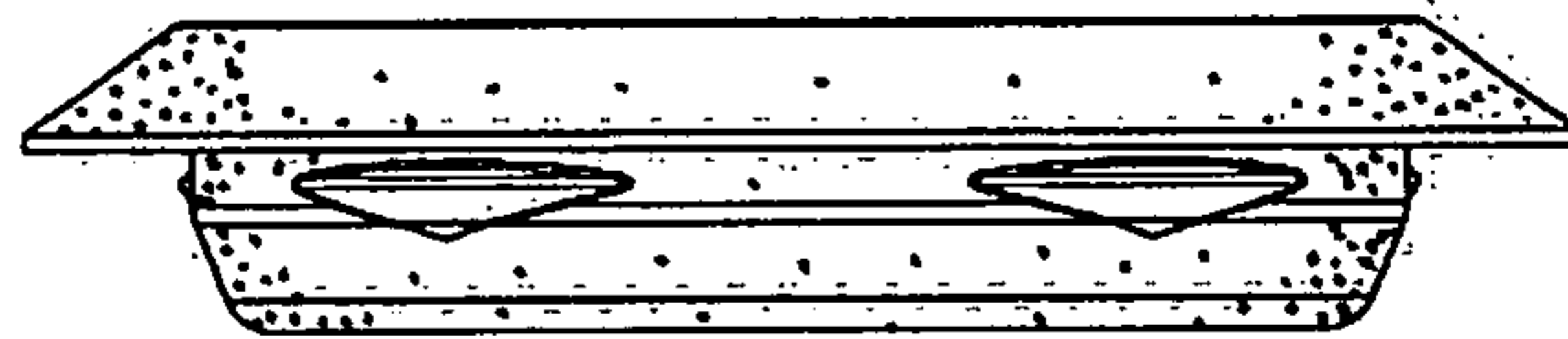

FIG. 16

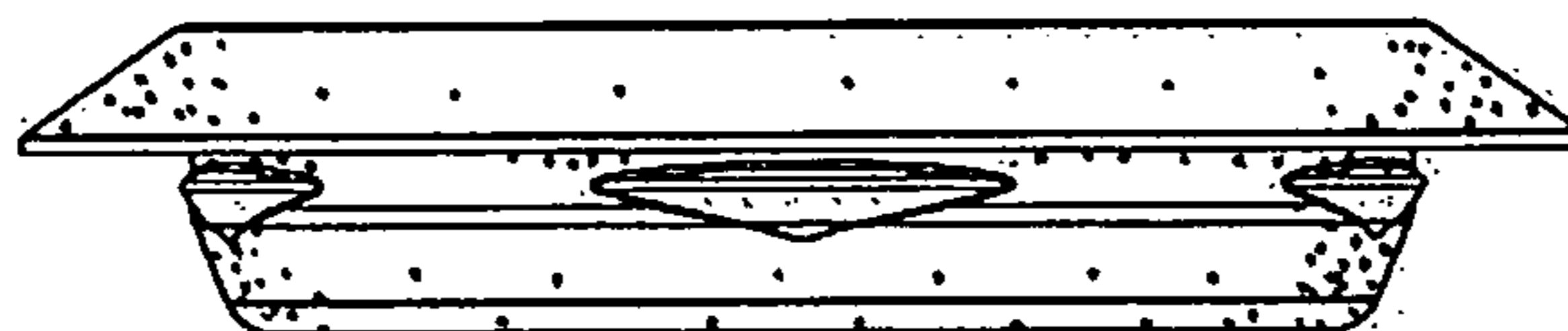

FIG. 17

