



US00D720874S

(12) **United States Design Patent**
Jackson et al.

(10) **Patent No.:** **US D720,874 S**
(45) **Date of Patent:** **** Jan. 6, 2015**

(54) **ENGINE HOOD LIGHTING DEVICE OF AN AGRICULTURAL VEHICLE**

(71) Applicant: **CNH America LLC**, New Holland, PA (US)

(72) Inventors: **Dwayne Jackson**, Plainfield, IL (US);
Eric M. Jacobsthal, Elmhurst, IL (US);
Douglas Montgomery, Downers Grove, IL (US); **Jonathan Eziquiel-Shriro**, Chicago, IL (US); **Jesse W. Gonzales**, Falls Church, VA (US)

(73) Assignee: **CNH Industrial America LLC**, New Holland, PA (US)

(**) Term: **14 Years**

(21) Appl. No.: **29/471,937**

(22) Filed: **Nov. 6, 2013**

(51) **LOC (10) Cl.** **26-06**

(52) **U.S. Cl.**
USPC **D26/28; D15/28; D15/31**

(58) **Field of Classification Search**
USPC D15/17, 22-26, 28, 31; D26/28-36,
D26/120, 122, 139; 362/61, 80, 81, 82, 83,
362/83.4, 267, 269, 275
See application file for complete search history.

(56) **References Cited**

U.S. PATENT DOCUMENTS

5,490,574	A	*	2/1996	Ishizumi et al.	180/68.1
D411,330	S	*	6/1999	Goebert et al.	D26/139
D426,905	S	*	6/2000	Cook et al.	D26/28
D441,469	S	*	5/2001	Goebert et al.	D26/28
D473,882	S	*	4/2003	Kuwae	D15/31
D474,206	S	*	5/2003	Kuwae	D15/31
D477,428	S	*	7/2003	Hill et al.	D26/28
D481,399	S	*	10/2003	Katoh	D15/31
D498,485	S	*	11/2004	Kuwae	D15/31
D532,022	S	*	11/2006	Kuwae	D15/31

D537,455	S	*	2/2007	Kuwae et al.	D15/31
D538,956	S	*	3/2007	Ishii	D26/28
D544,614	S	*	6/2007	Markefka	D26/28
D558,238	S	*	12/2007	Kuwae	D15/31
D561,358	S	*	2/2008	Tachibana	D26/28
D591,777	S	*	5/2009	Kokitkar et al.	D15/31
D642,597	S	*	8/2011	Krogh et al.	D15/31
D646,305	S	*	10/2011	Krogh et al.	D15/31

(Continued)

Primary Examiner — Mark Goodwin

(74) *Attorney, Agent, or Firm* — Sue C. Watson

(57) **CLAIM**

The ornamental design for an engine hood lighting device of an agricultural vehicle, substantially as shown and described.

DESCRIPTION

FIG. 1 is a perspective view of an engine hood lighting device of an agricultural vehicle showing our new design in use condition, in which the phantom lines illustrate portions of an engine hood assembly that forms no part of the claimed design;

FIG. 2 is a front view thereof;

FIG. 3 is a back view thereof;

FIG. 4 is a left side elevation view thereof;

FIG. 5 is a right side elevation view thereof;

FIG. 6 is a top view thereof;

FIG. 7 is a bottom view thereof;

FIG. 8 is an enlarged perspective view of one side of the engine hood lighting device of an agricultural vehicle shown separate from the hood thereof, in which the phantom lines illustrate portions of the engine hood lighting device of an agricultural vehicle that forms no part of the claimed design;

FIG. 9 is a top view thereof;

FIG. 10 is a bottom view thereof;

FIG. 11 is a left side elevation view thereof;

FIG. 12 is a right side elevation view thereof;

FIG. 13 is a front view thereof; and,

FIG. 14 is a back view thereof.

1 Claim, 10 Drawing Sheets

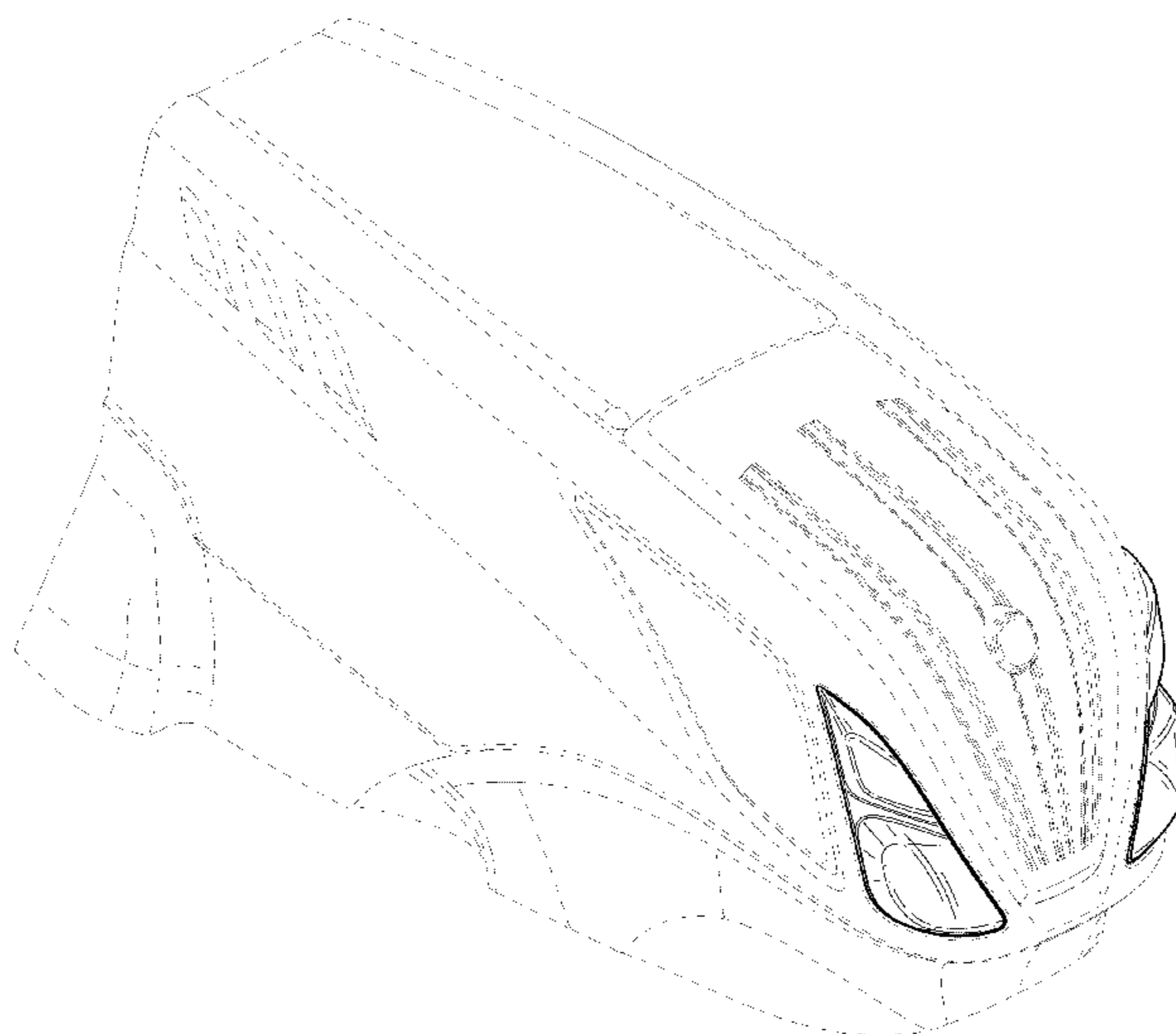

US D720,874 S

Page 2

(56)

References Cited

U.S. PATENT DOCUMENTS

D654,197 S *	2/2012	Szews et al.	D26/28	
D665,429 S *	8/2012	Hickman et al.	D15/31	* cited by examiner
D668,695 S *	10/2012	Ringer	D15/31	
D707,729 S *	6/2014	Jackson et al.	D15/31	
D707,730 S *	6/2014	Jackson et al.	D15/31	

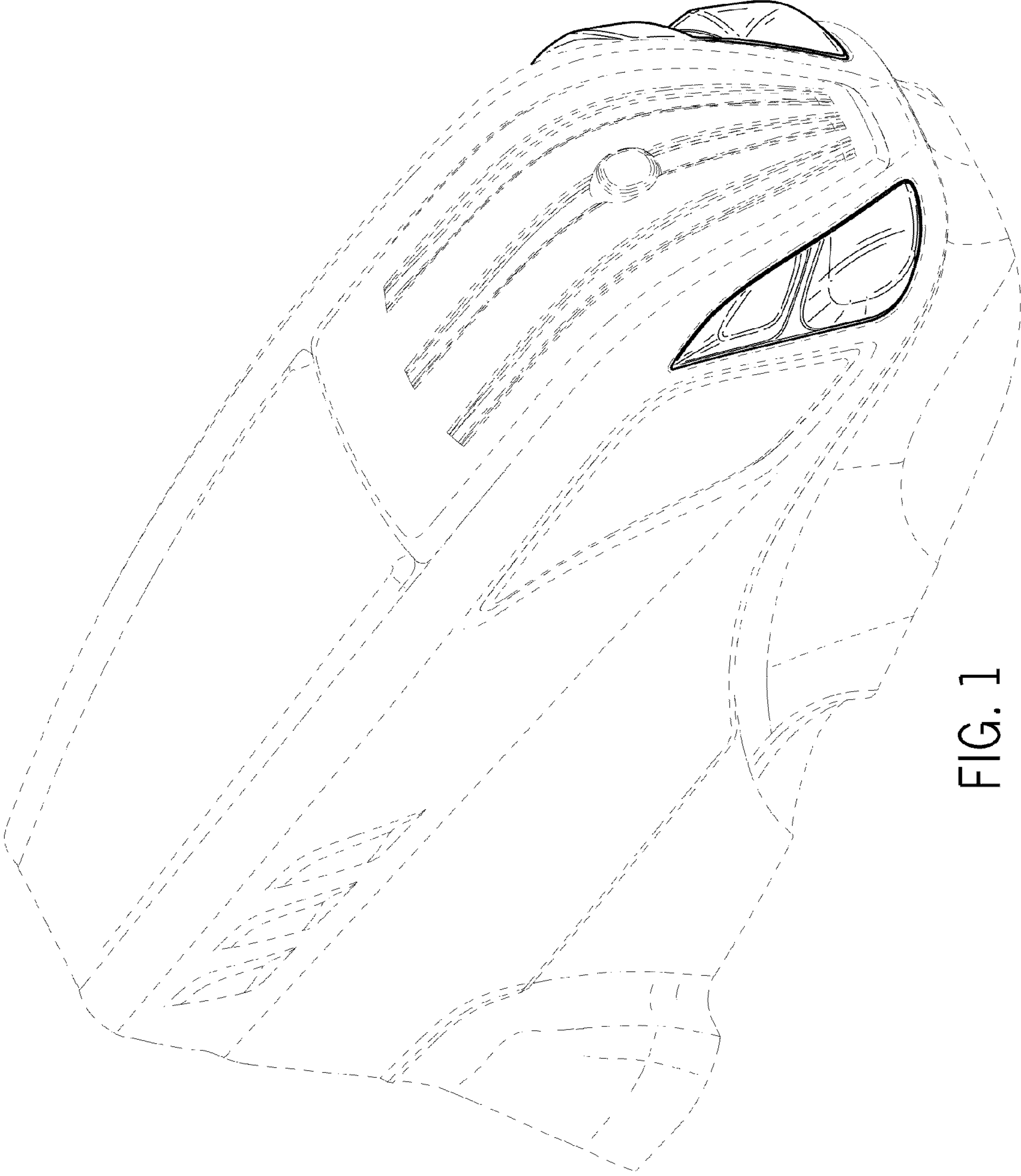

FIG. 1

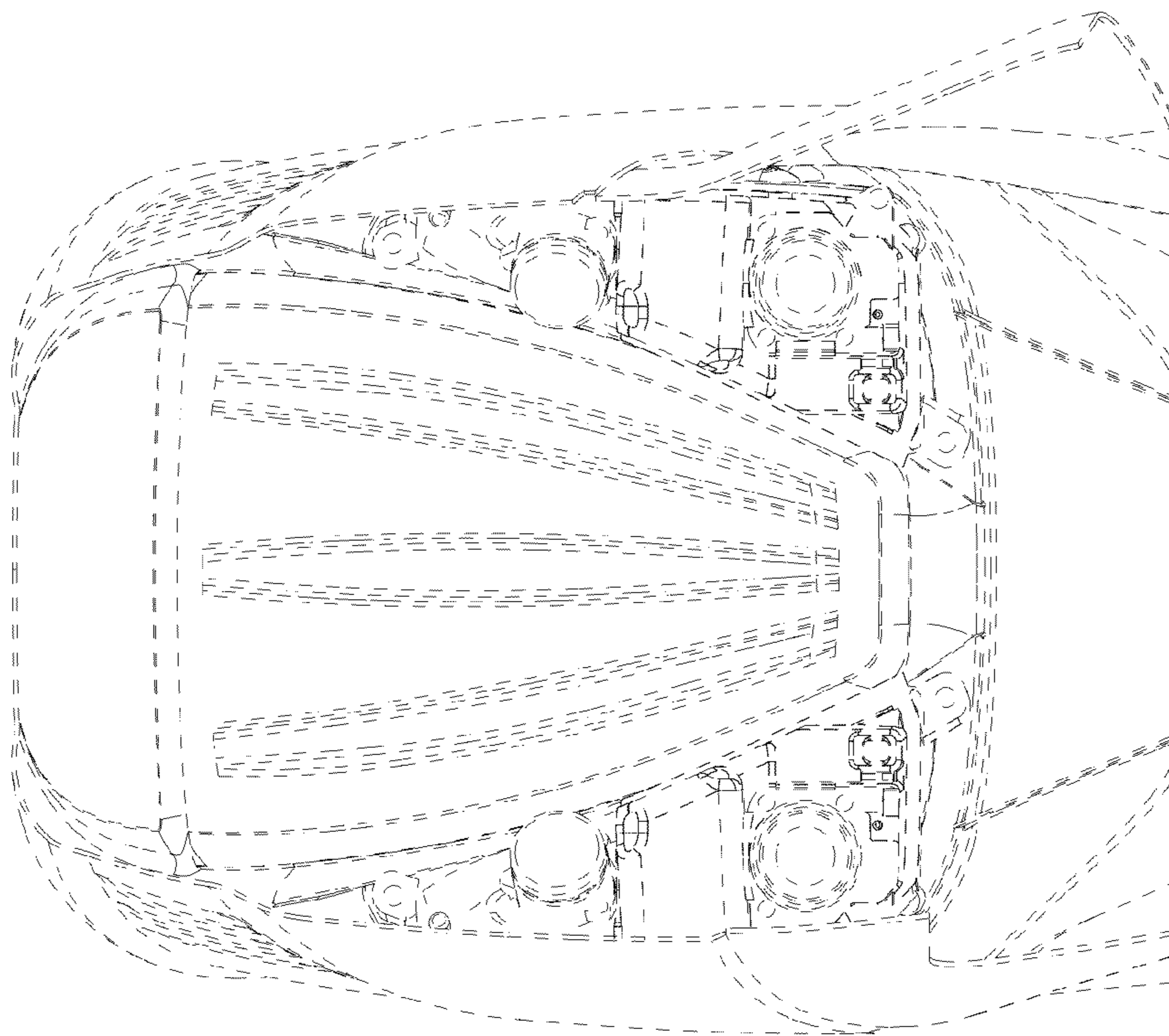

FIG. 3

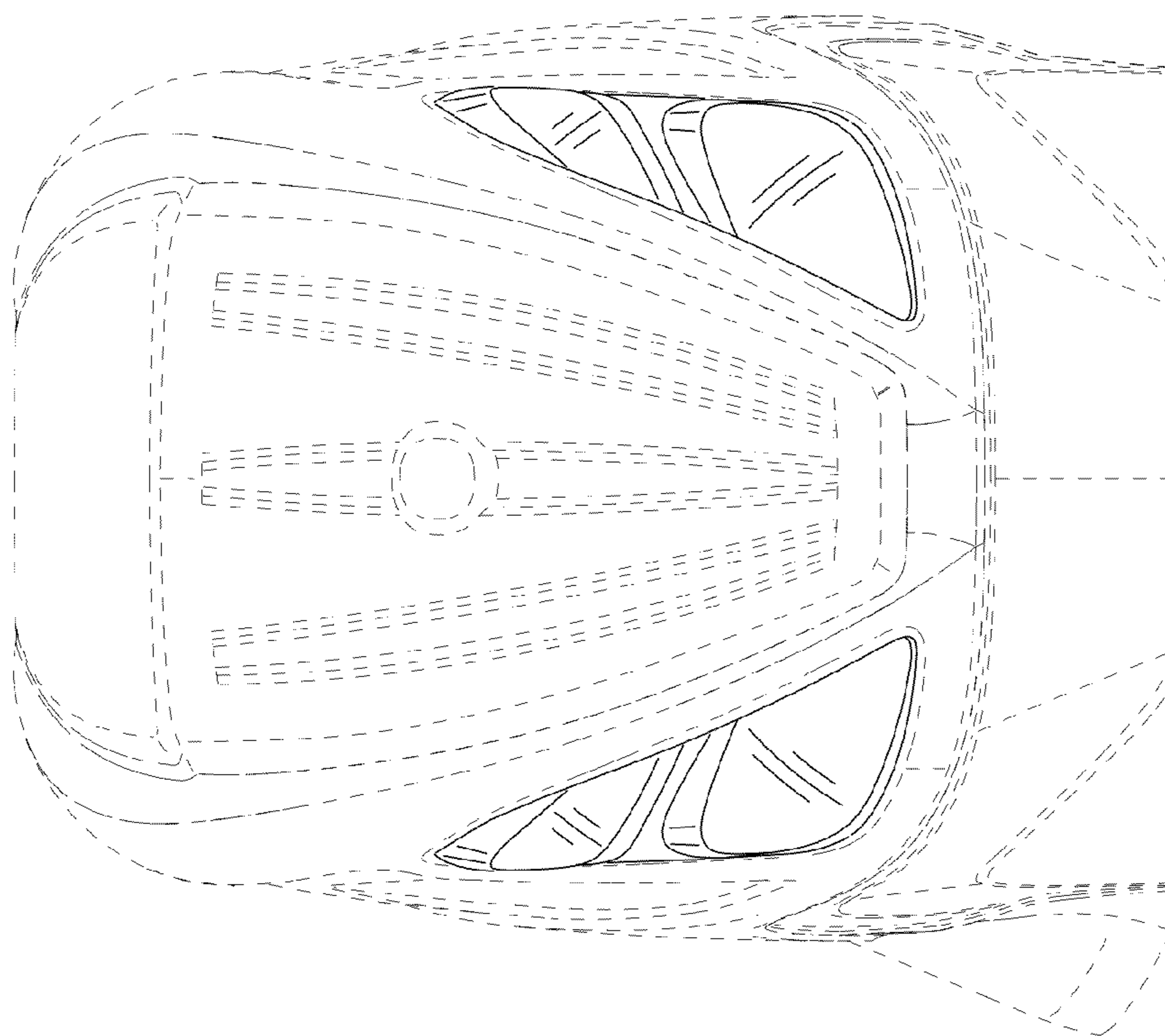

FIG. 2

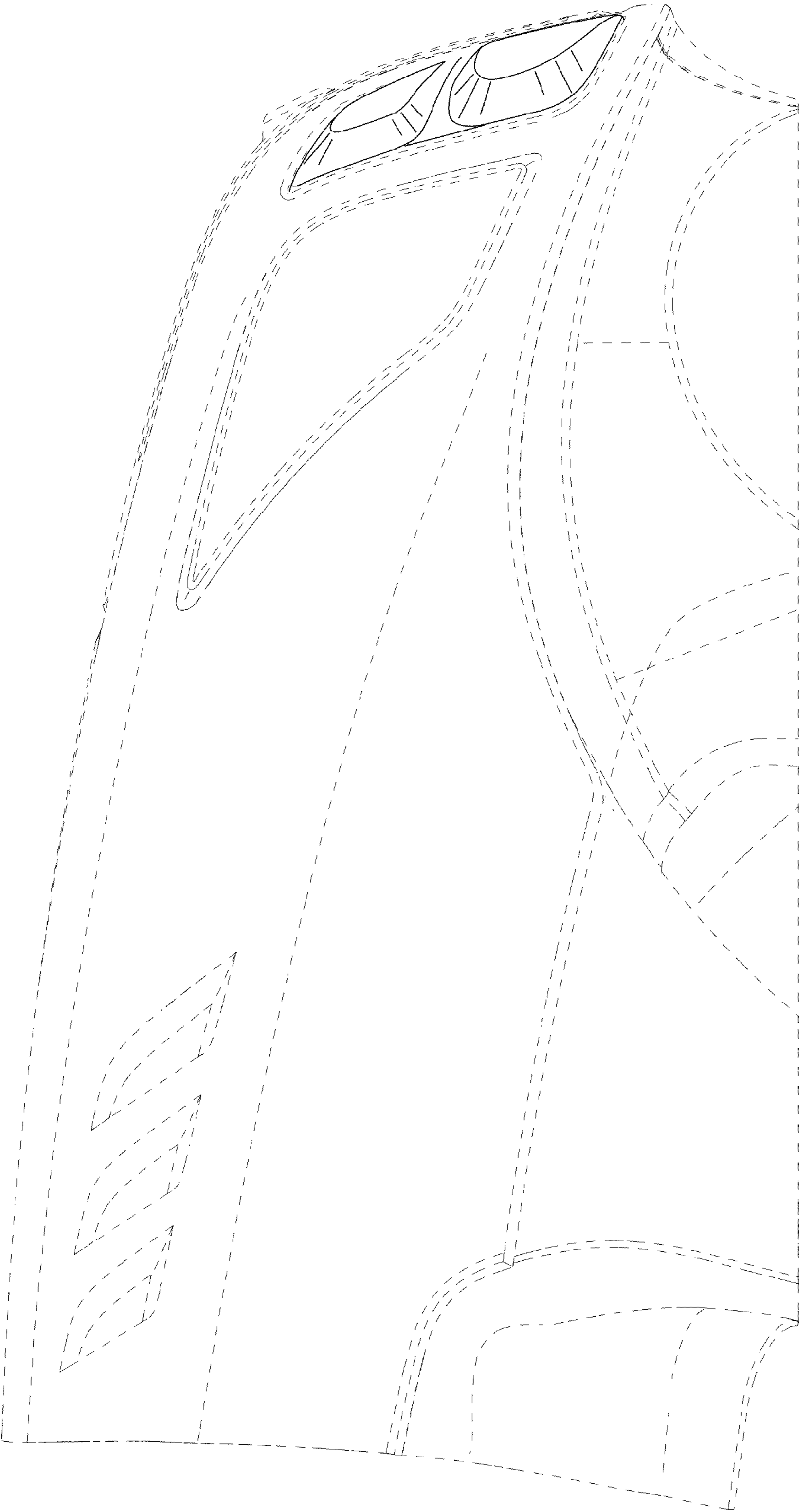

FIG. 4

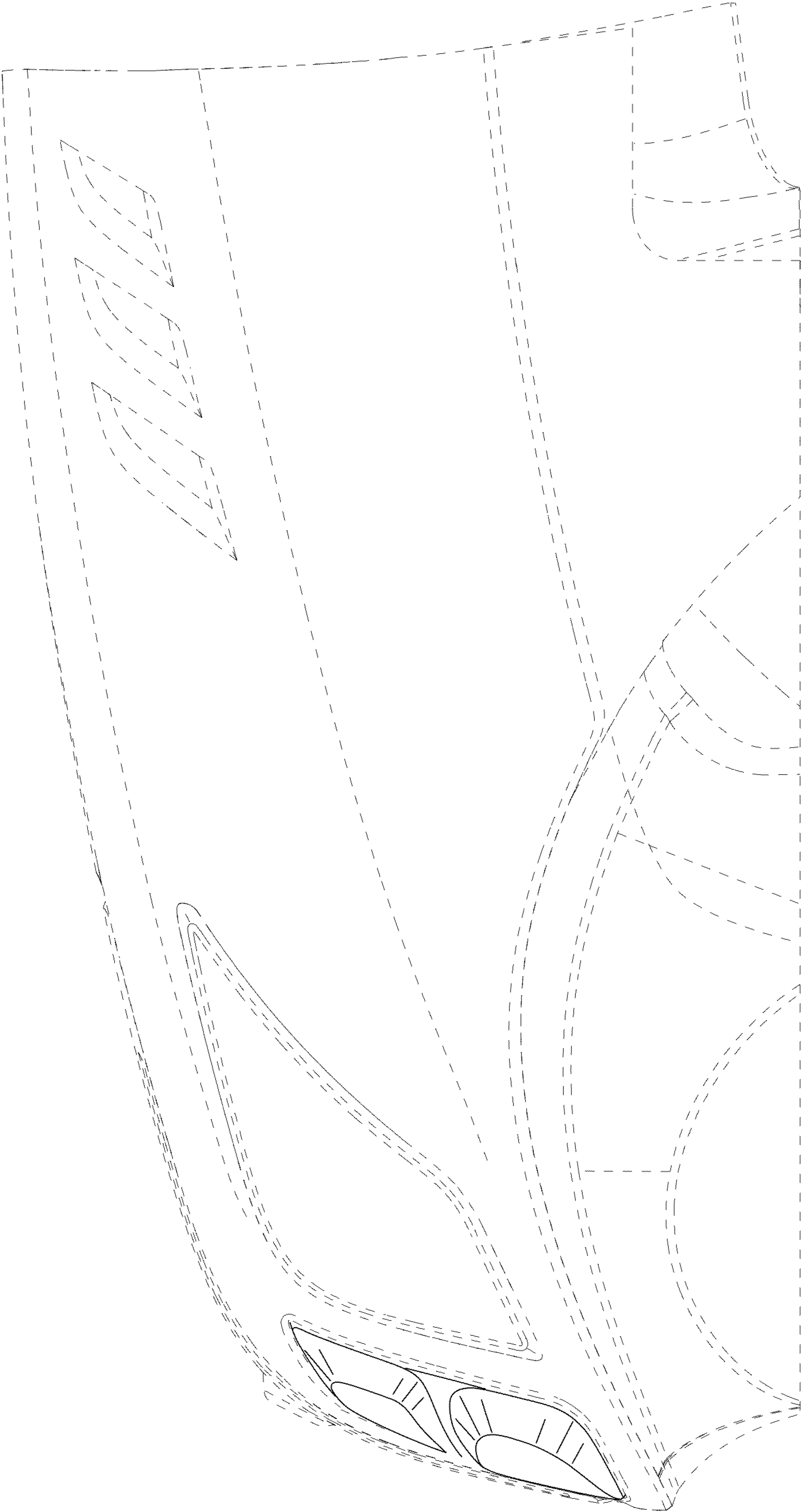

FIG. 5

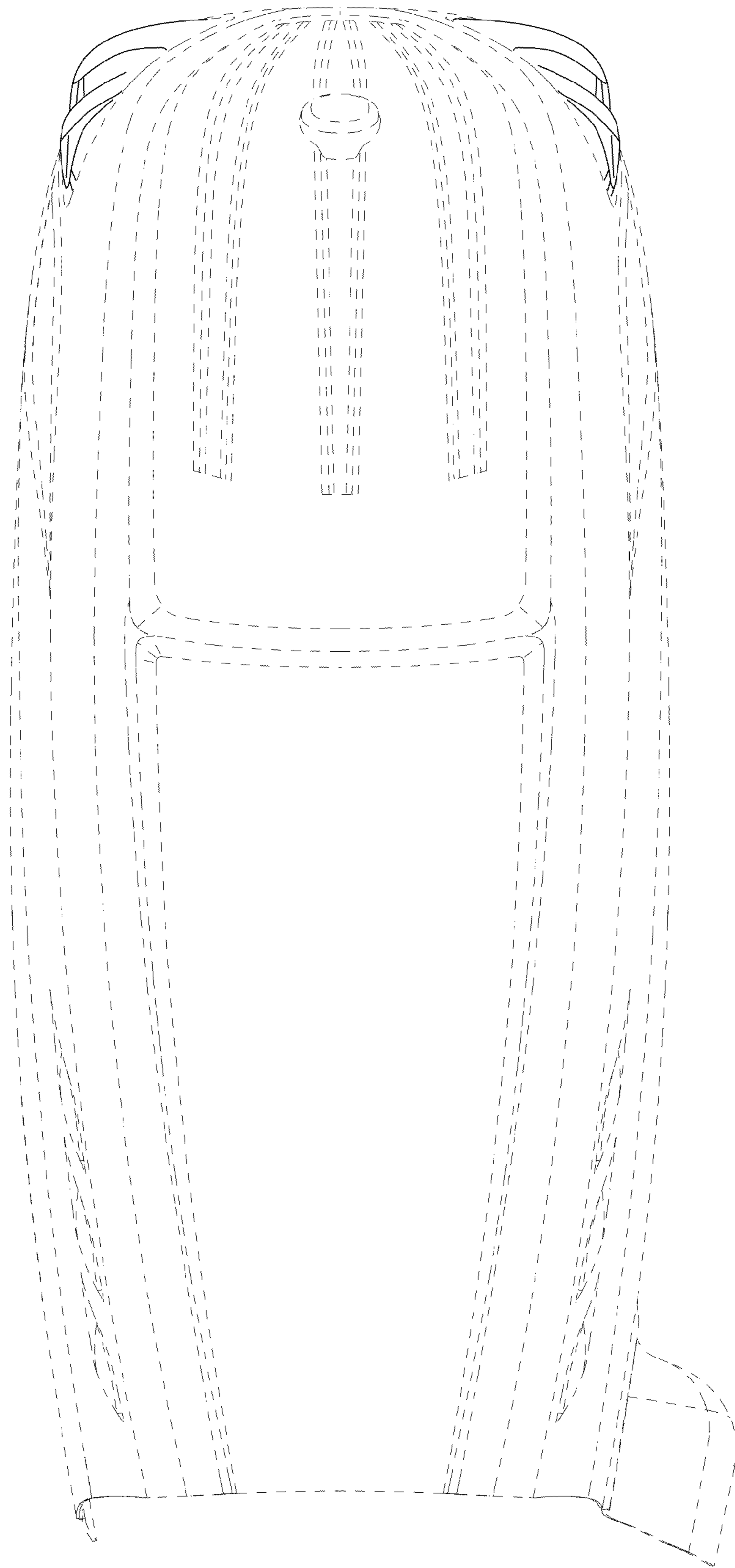

FIG. 6

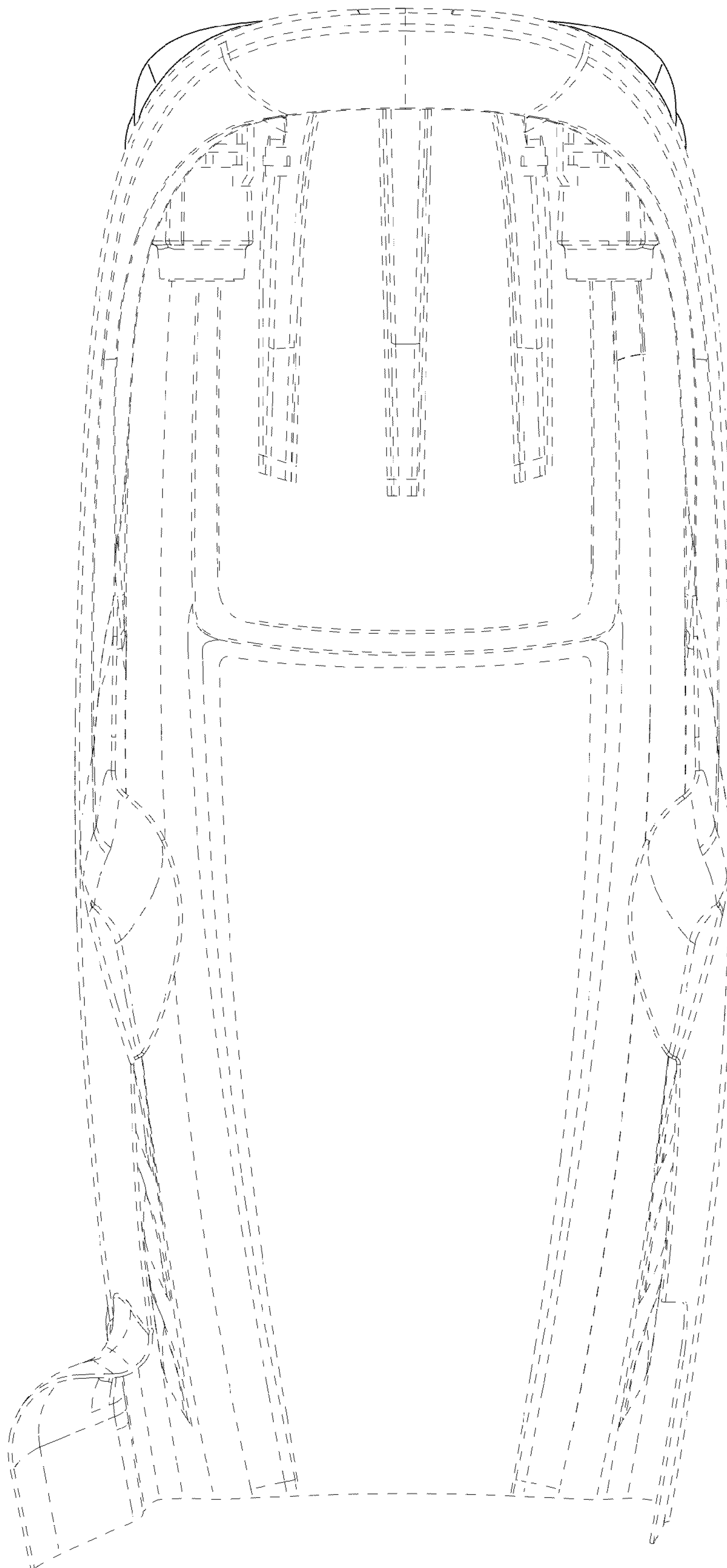

FIG. 7

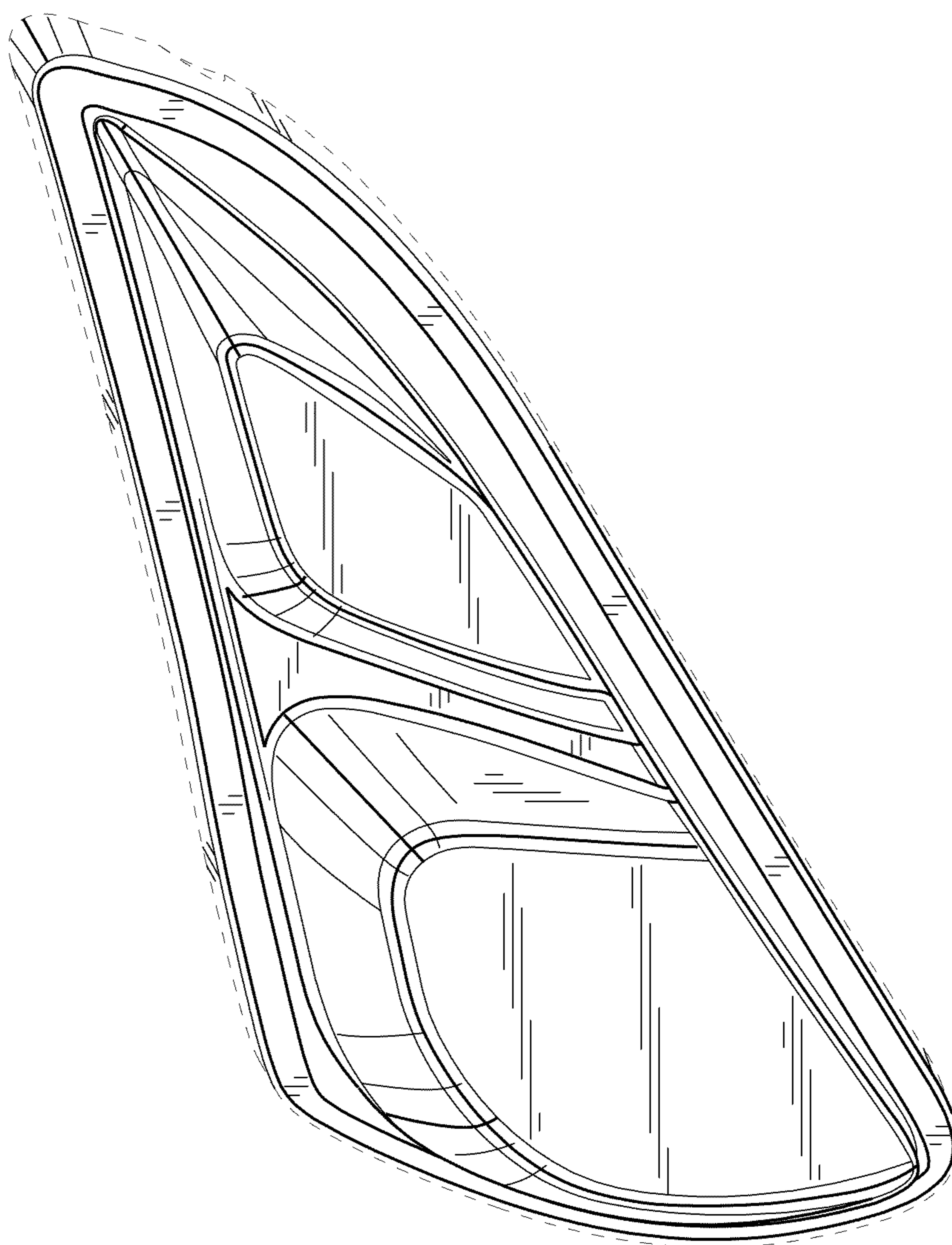

FIG. 8

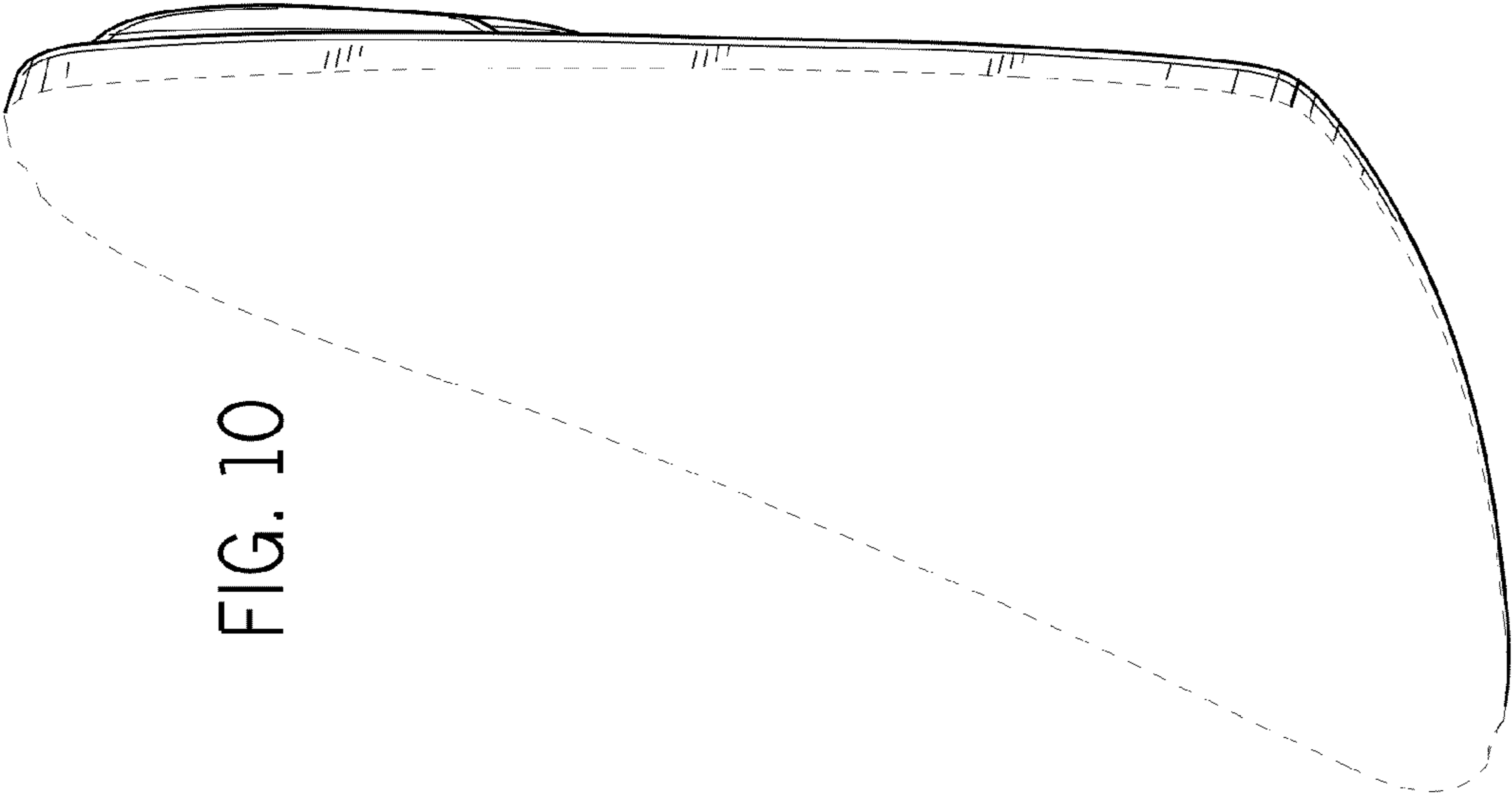

FIG. 10

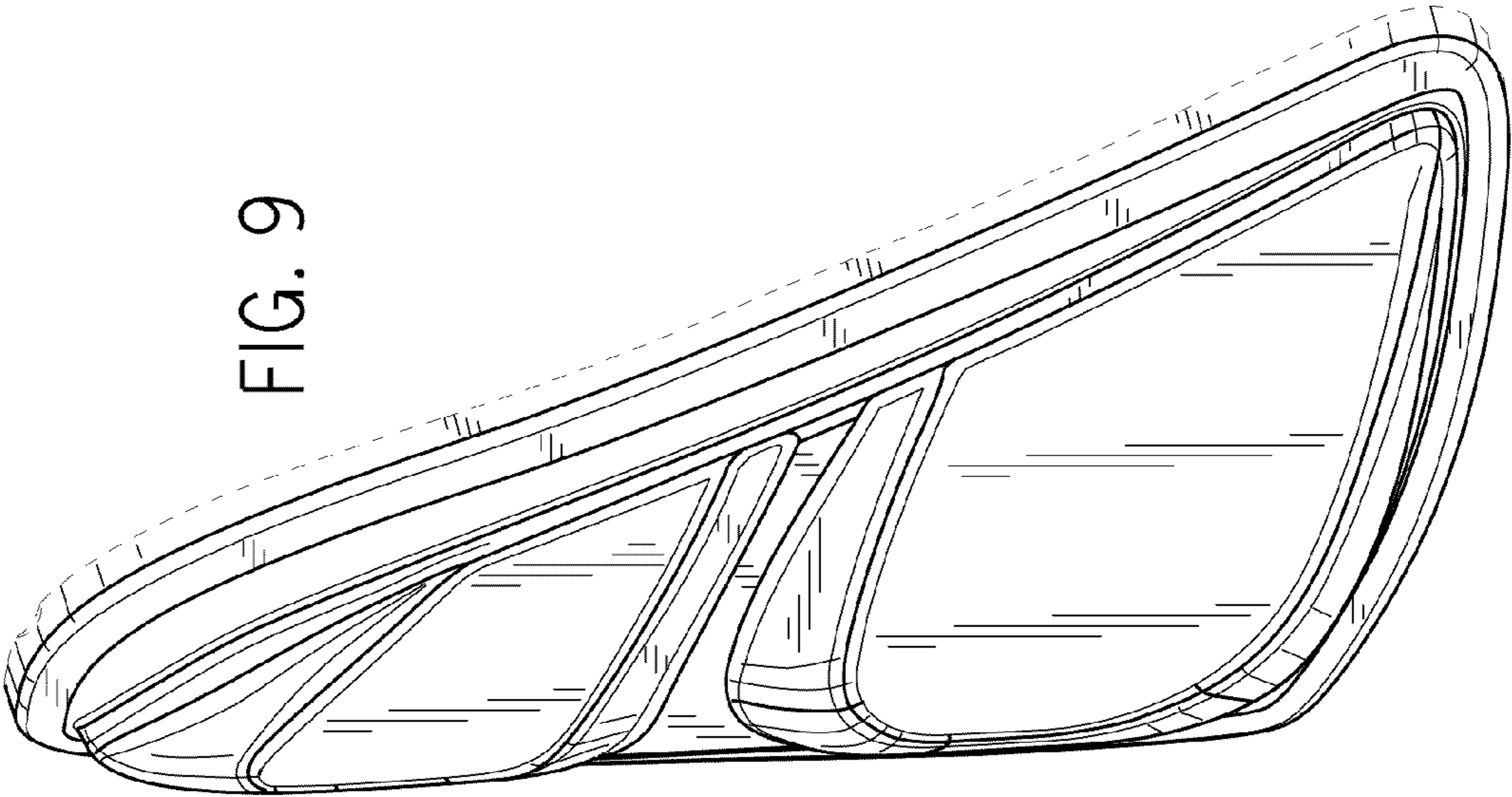

FIG. 9

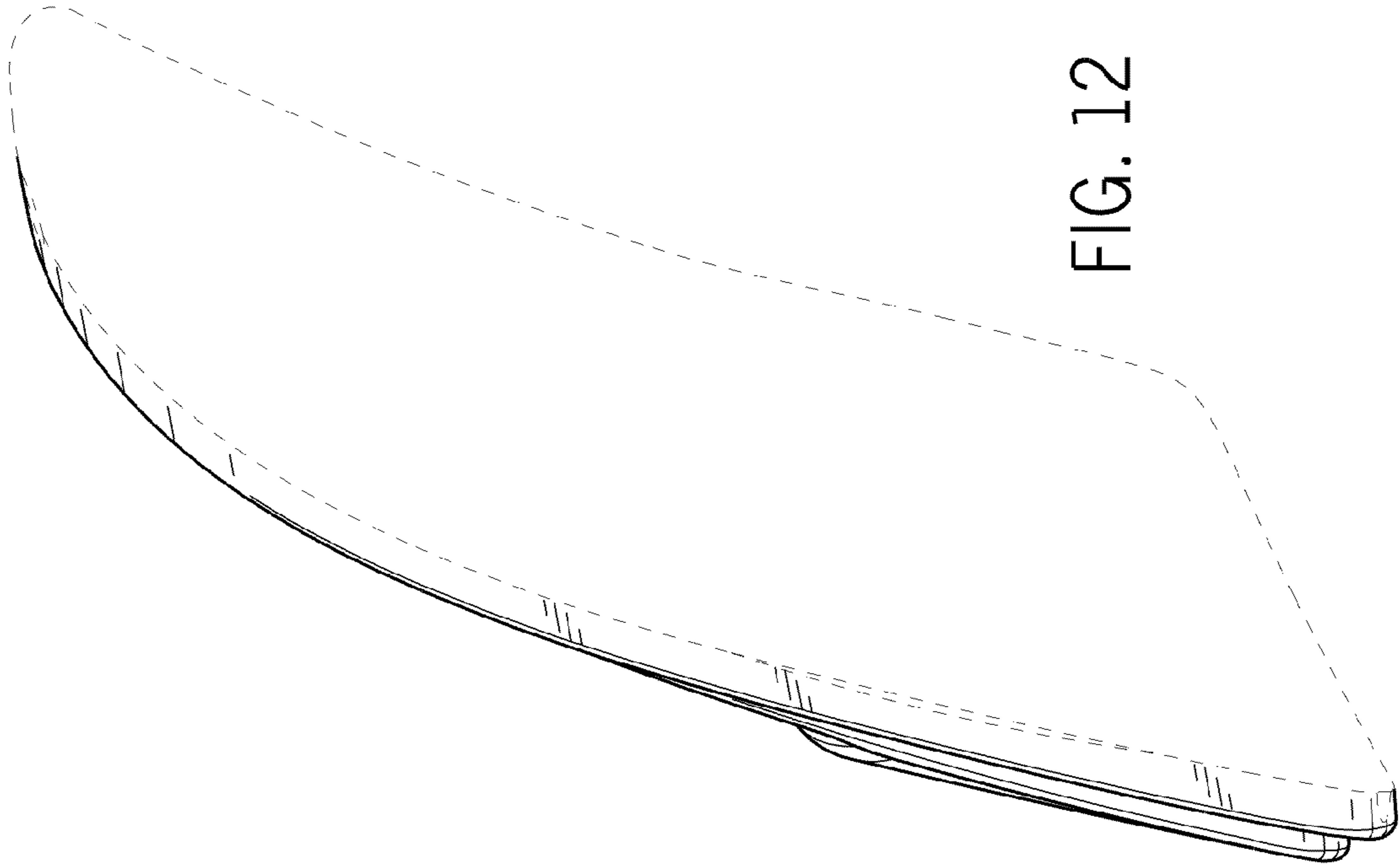

FIG. 12

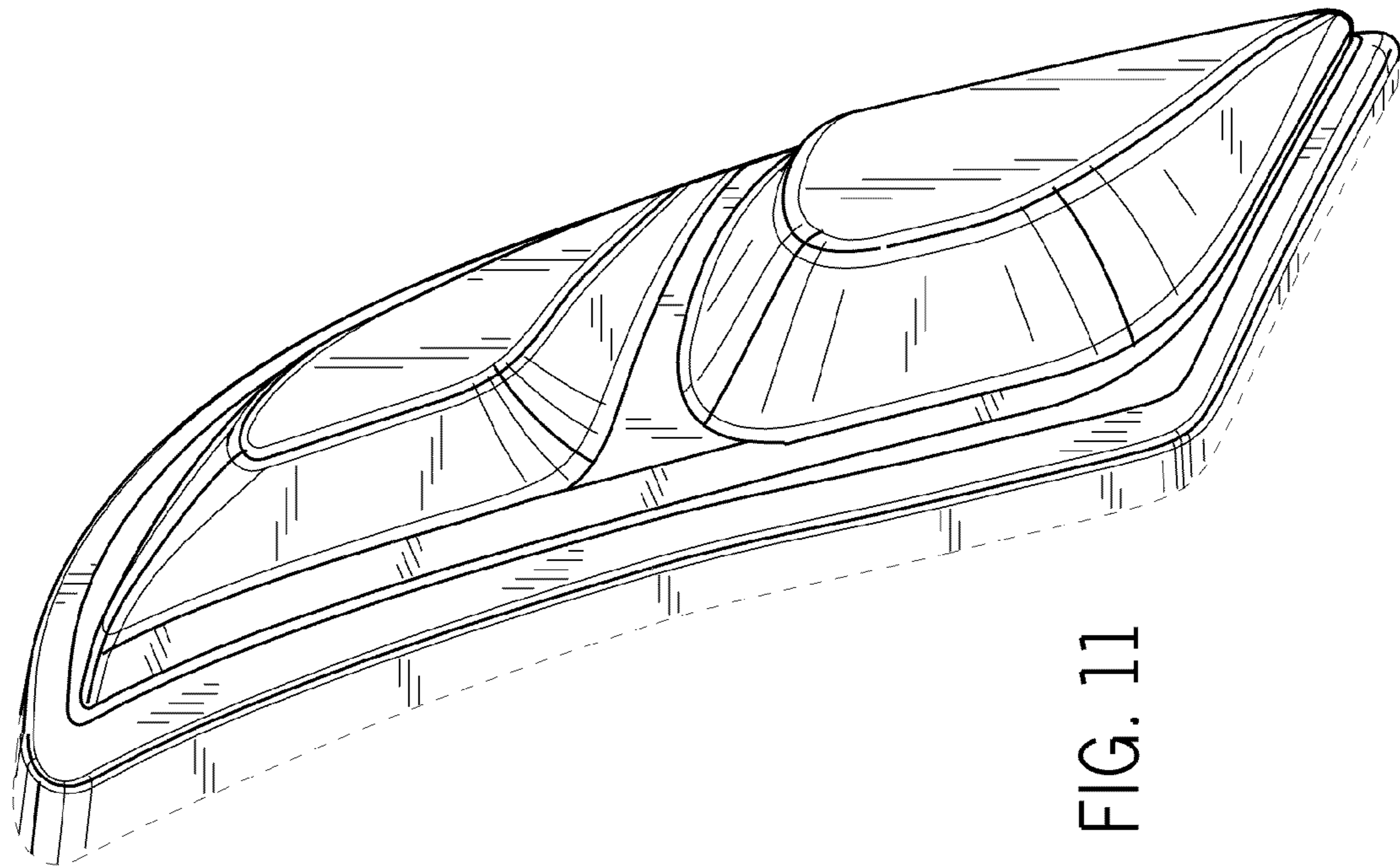

FIG. 11

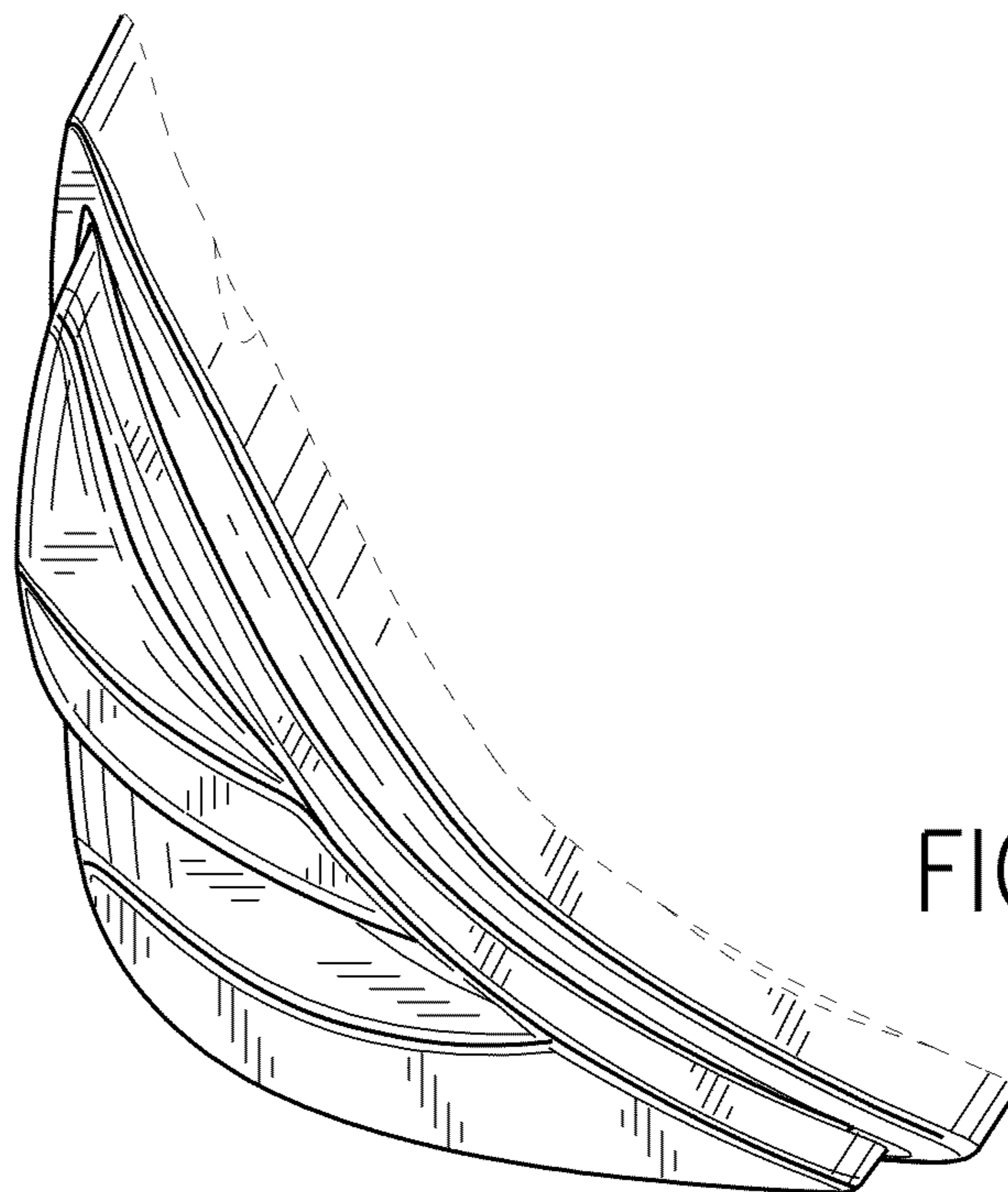

FIG. 13

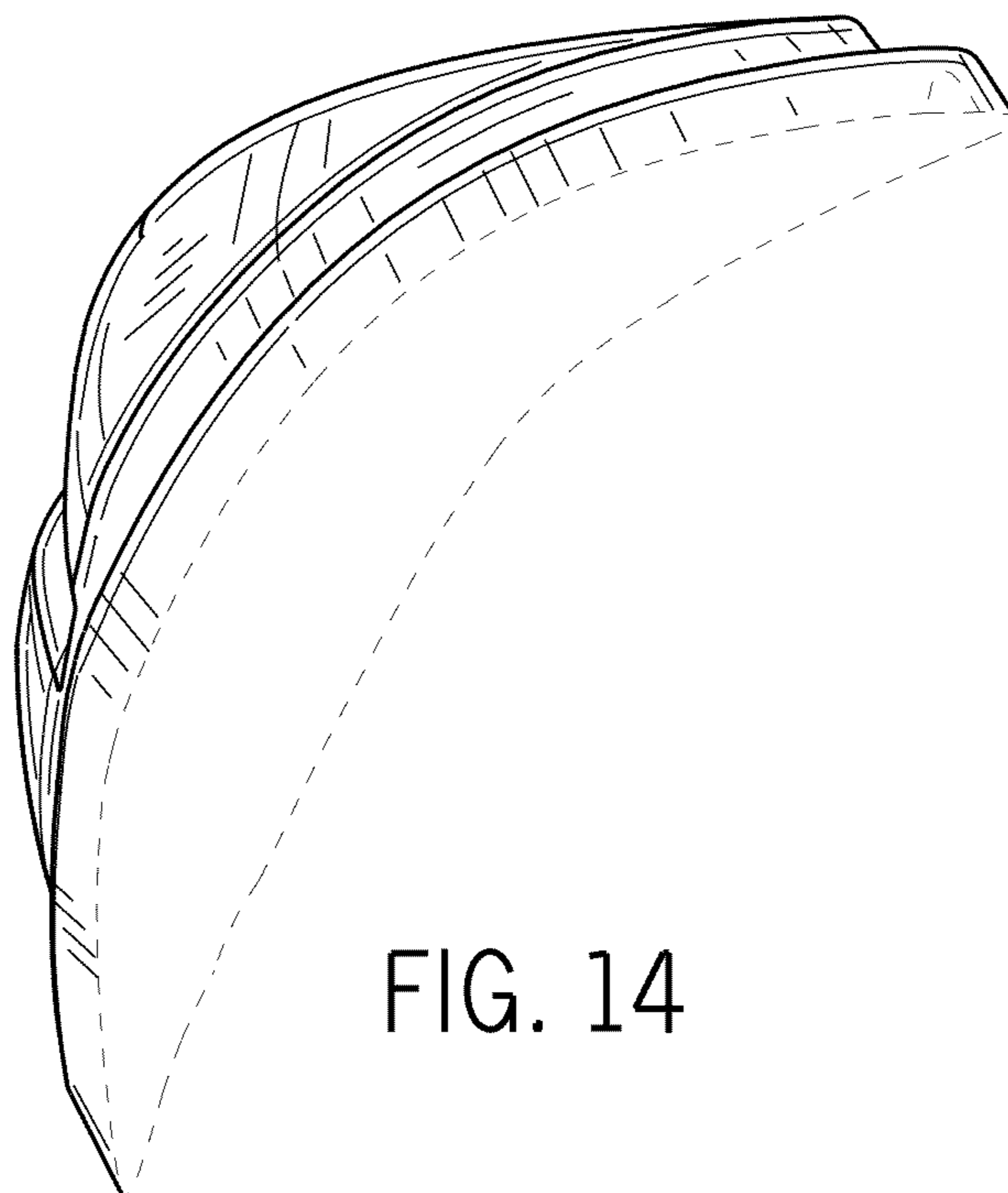

FIG. 14