



US00D720696S

(12) **United States Design Patent**  
**Huang**

(10) **Patent No.:** **US D720,696 S**  
(45) **Date of Patent:** **\*\* Jan. 6, 2015**

(54) **BATTERY BOX**

(76) Inventor: **Chiang Huang**, Taipei (TW)

(\*\*) Term: **14 Years**

(21) Appl. No.: **29/416,037**

(22) Filed: **Mar. 16, 2012**

(51) **LOC (10) Cl.** ..... **13-02**

(52) **U.S. Cl.**  
USPC ..... **D13/119**

(58) **Field of Classification Search**  
USPC ..... D3/201, 203.3, 207, 208, 211, 212, 218,  
D3/269, 270, 271.1, 271.2, 271.3, 273,  
D3/282, 283, 284, 304, 305, 307, 310, 313,  
D3/315, 316, 901; D13/102–110, 118,  
D13/119, 152, 156, 184, 199; D14/217,  
D14/251, 253, 432, 434; D19/75; 206/373,  
206/703; 320/103, 107, 108, 110, 112–115;  
429/96–100, 163, 176

See application file for complete search history.

(56) **References Cited**

**U.S. PATENT DOCUMENTS**

D391,078 S \* 2/1998 Jacober et al. .... D3/313  
D413,442 S \* 9/1999 Jacober et al. .... D3/313  
D468,688 S \* 1/2003 Helman ..... D13/119

D476,950 S \* 7/2003 Peress et al. .... D13/103  
D490,375 S \* 5/2004 Pomerance ..... D13/119  
D624,016 S \* 9/2010 Seehoff et al. .... D13/119  
D692,824 S \* 11/2013 Fiaschetti ..... D13/108

\* cited by examiner

*Primary Examiner* — Adir Aronovich

*Assistant Examiner* — Ramzi Almatrahi

(74) *Attorney, Agent, or Firm* — Li & Cai Intellectual Property (USA) Office

(57) **CLAIM**

The ornamental design for a “battery box,” as shown and described.

**DESCRIPTION**

FIG. 1 is a perspective view of a “battery box” showing my new design;  
FIG. 2 is a front elevational view thereof;  
FIG. 3 is a rear elevational view thereof;  
FIG. 4 is a left side elevational view thereof;  
FIG. 5 is a right side elevational view thereof;  
FIG. 6 is a top plan view thereof; and,  
FIG. 7 is a bottom plan view thereof.  
The broken lines depict portions of the battery box in which the design is embodied and form no part of the claimed design.

**1 Claim, 5 Drawing Sheets**

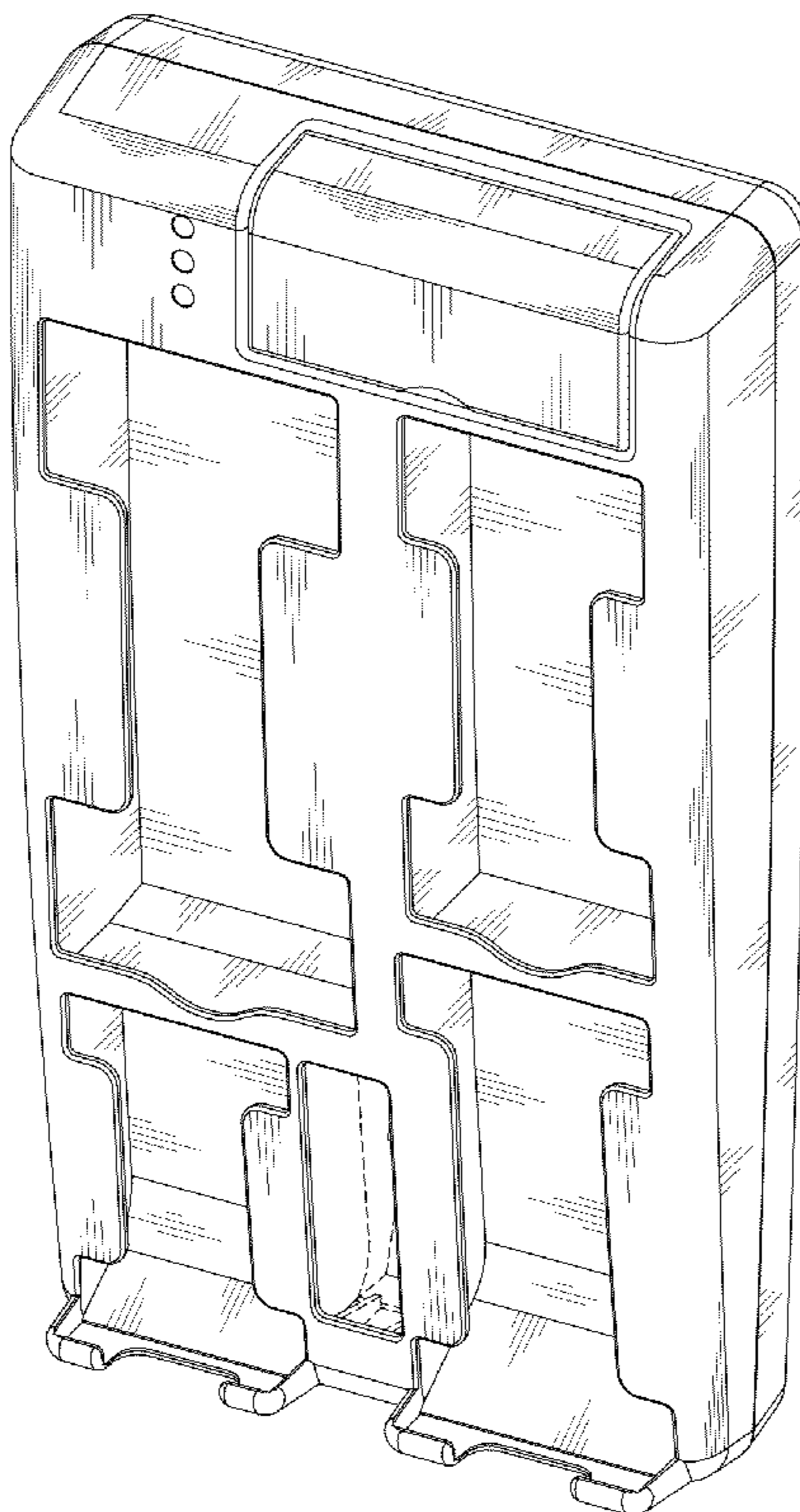

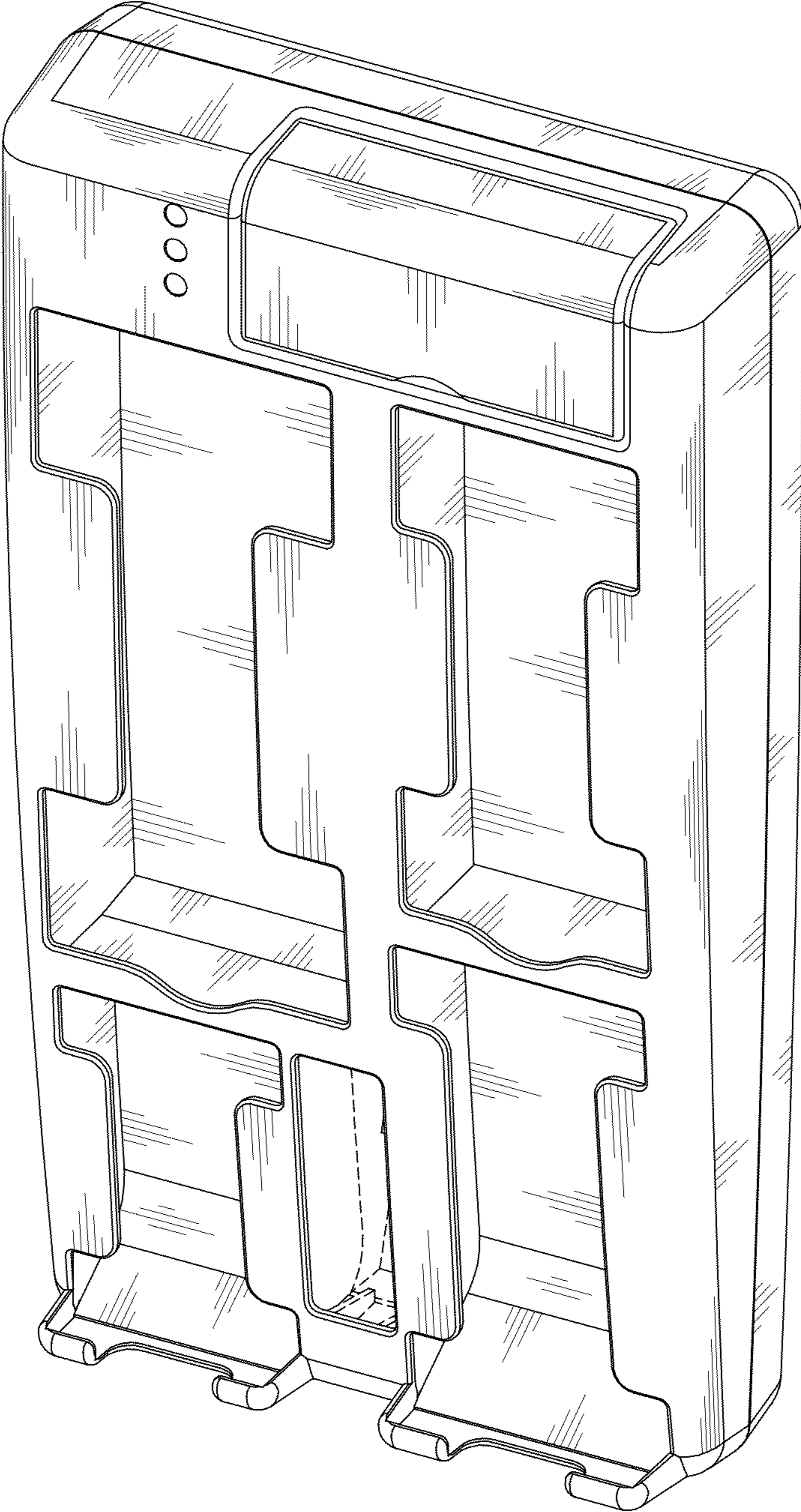

FIG.1

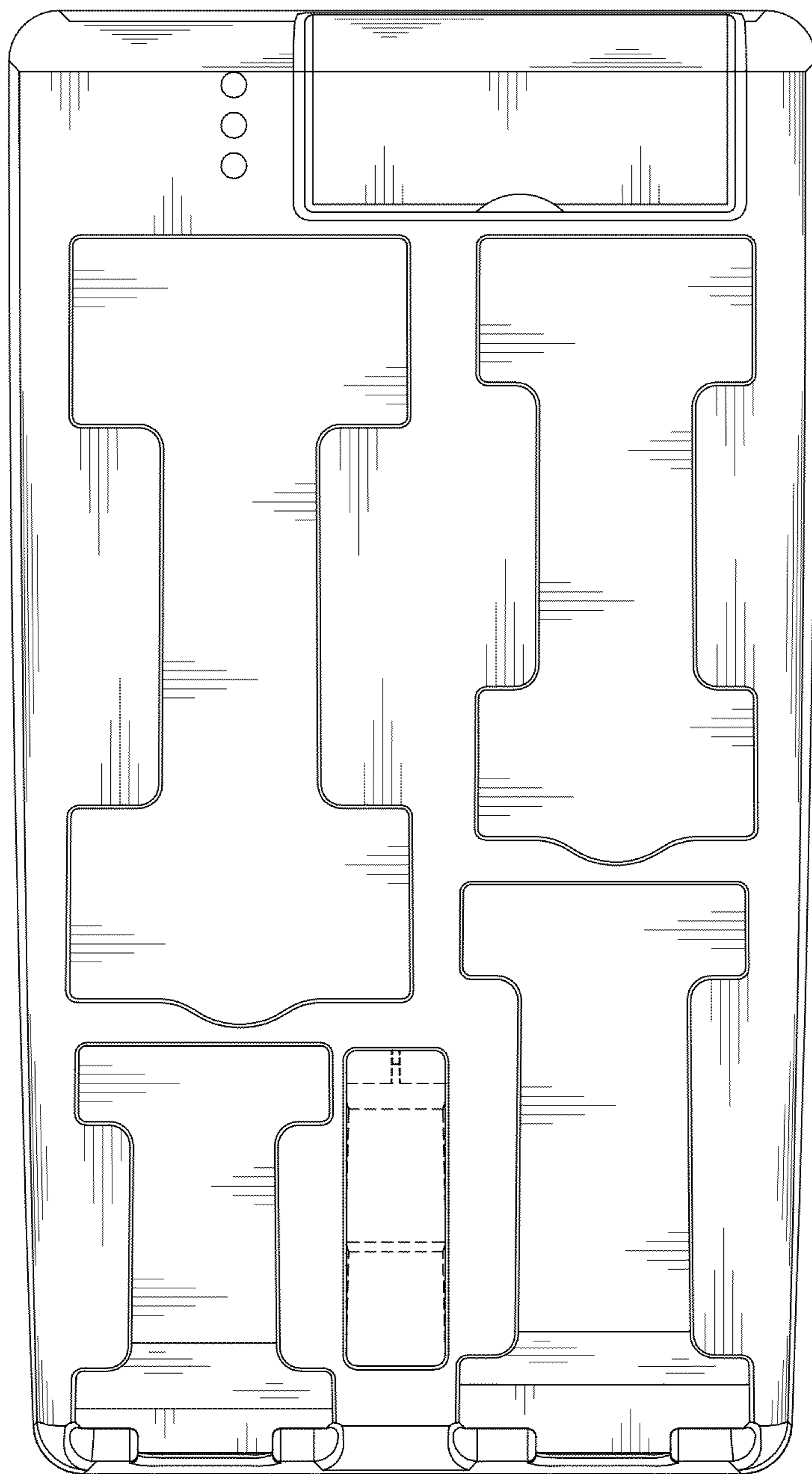

FIG.2

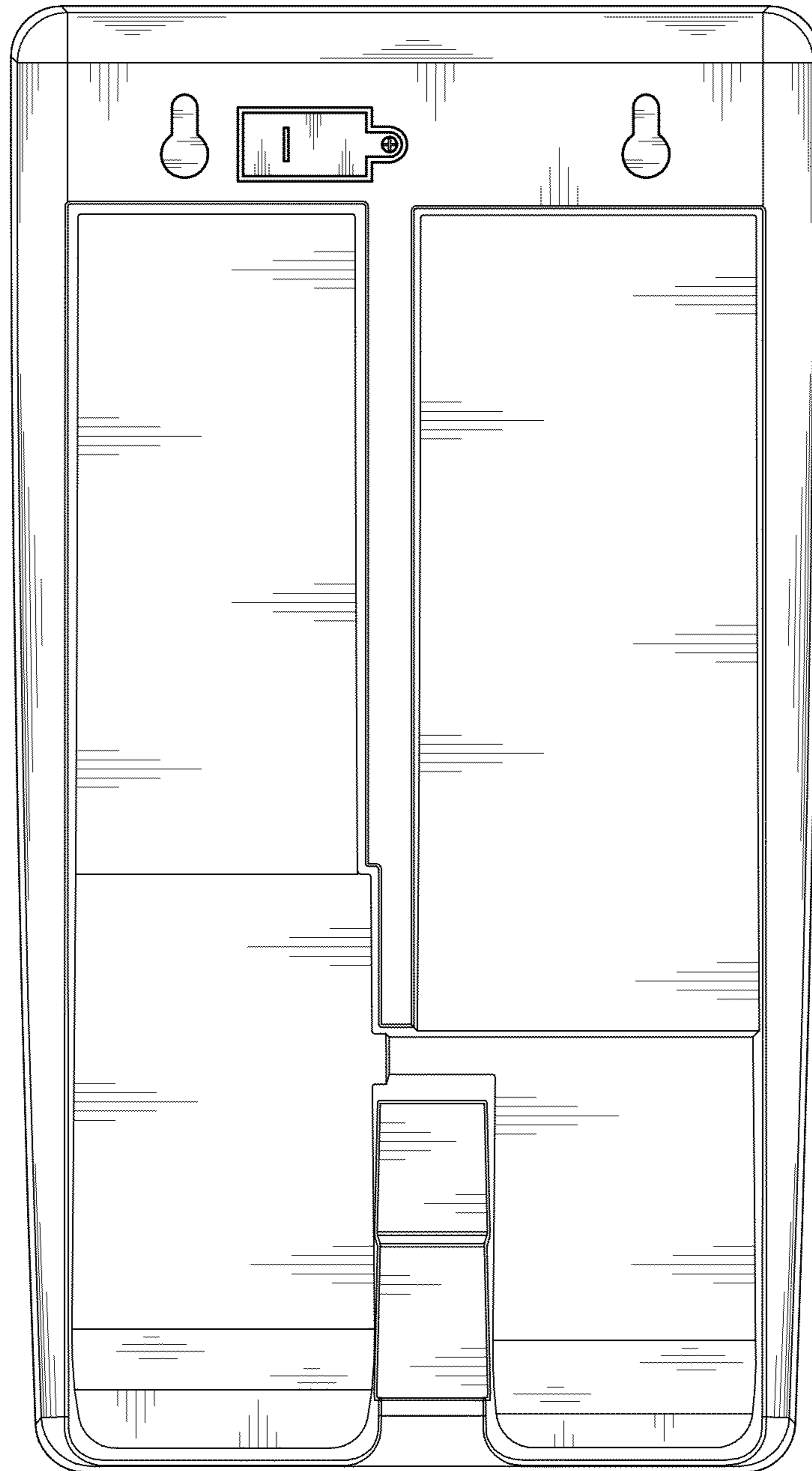

FIG.3

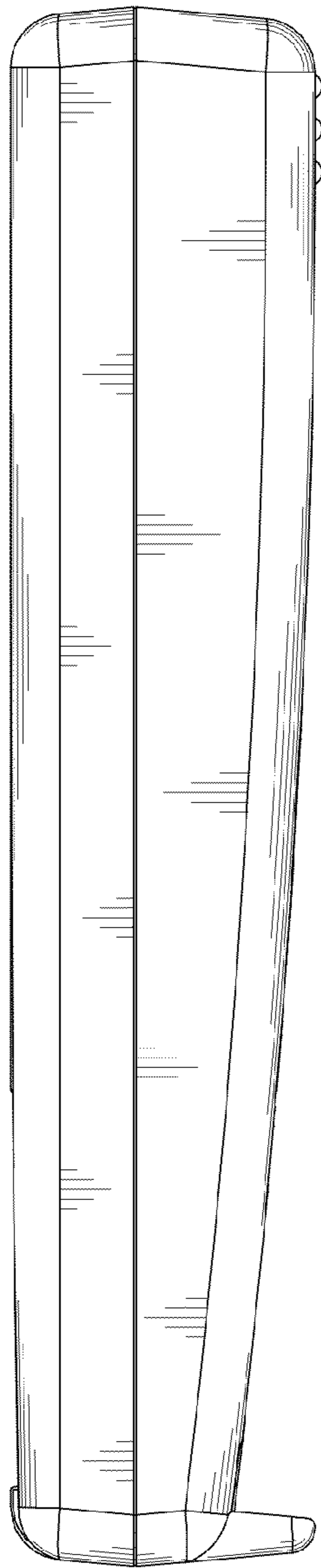

FIG. 4

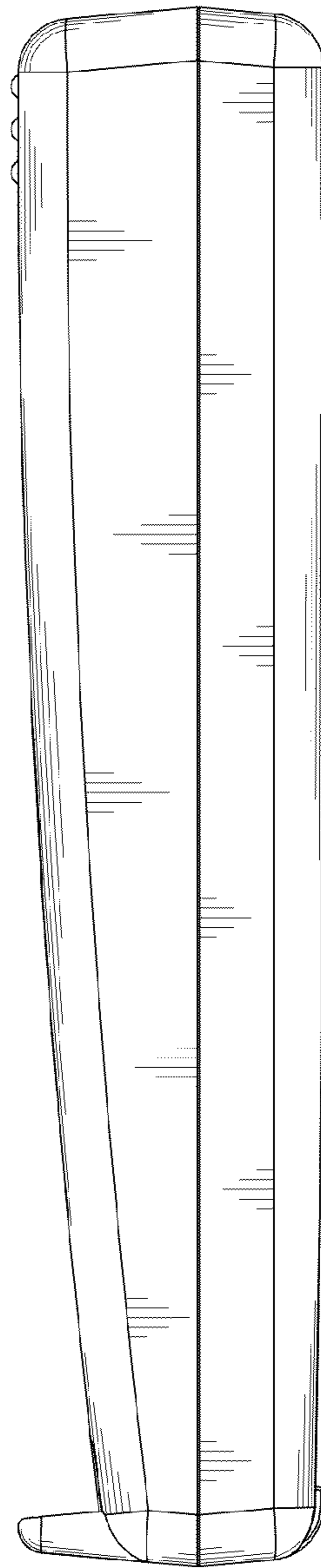

FIG. 5

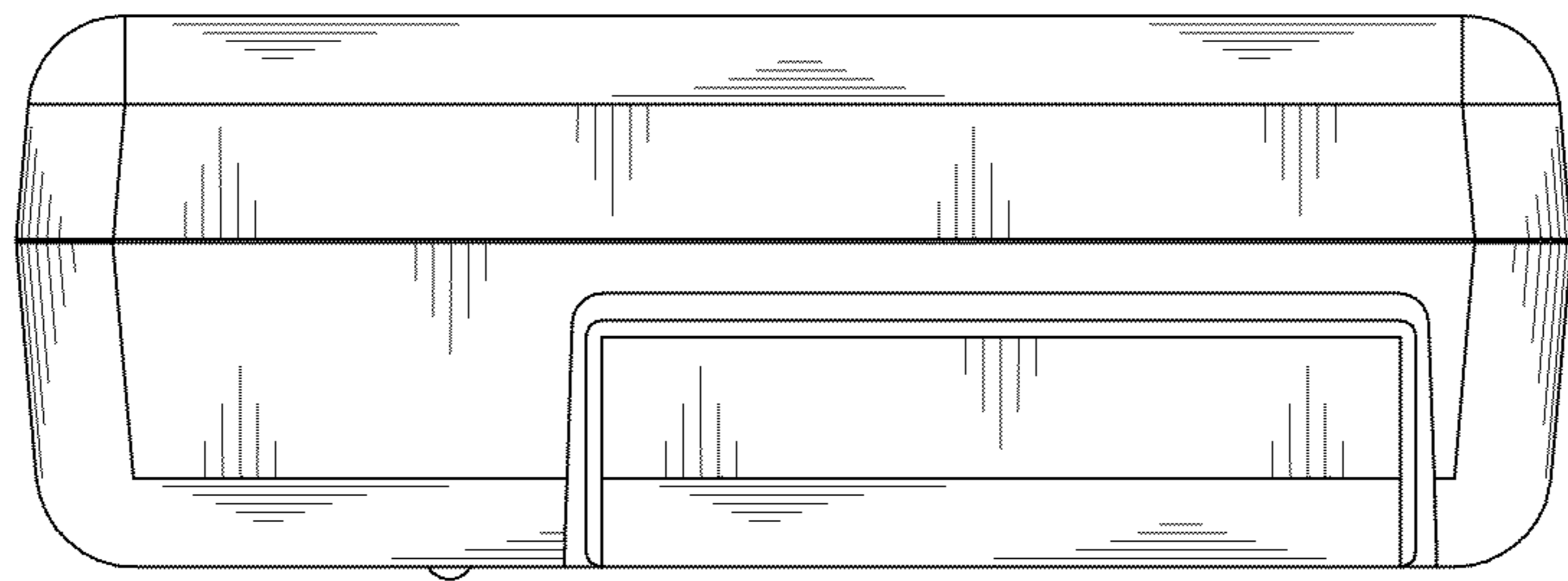

FIG. 6

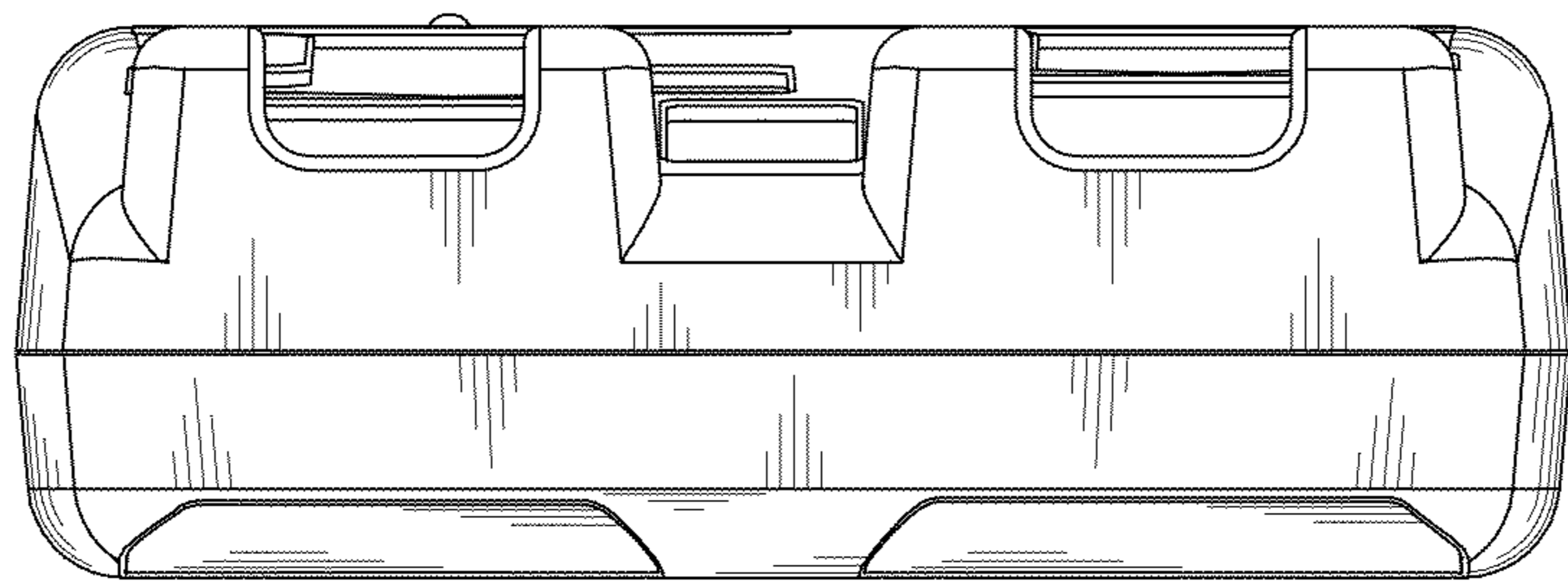

FIG. 7