



US00D720667S

(12) **United States Design Patent**  
**Platto et al.**

(10) **Patent No.:** **US D720,667 S**  
(45) **Date of Patent:** **\*\* Jan. 6, 2015**

(54) **VEHICLE FRONT BUMPER LOWER GRILLE**

(56) **References Cited**

(71) Applicant: **Ford Motor Company**, Dearborn, MI (US)

U.S. PATENT DOCUMENTS

(72) Inventors: **Gordon M. Platto**, Troy, MI (US);  
**Bradley A. Richards**, Bloomfield Hills, MI (US); **Moray S. Callum**, Ann Arbor, MI (US); **Joel Piaskowski**, Brighton (AU); **John Kim**, Ann Arbor, MI (US); **William K. Moore**, West Bloomfield, MI (US)

D540,720 S \* 4/2007 Golden et al. .... D12/163  
D570,748 S \* 6/2008 Nakamura et al. .... D12/169  
D571,265 S \* 6/2008 Suzuki et al. .... D12/169  
D573,067 S \* 7/2008 Ho ..... D12/163

\* cited by examiner

(73) Assignee: **Ford Motor Company**, Dearborn, MI (US)

*Primary Examiner* — Melody Brown  
(74) *Attorney, Agent, or Firm* — Damian Porcari

(\*\*) Term: **14 Years**

(57) **CLAIM**  
The ornamental design for a vehicle front bumper lower grille, as shown and described.

(21) Appl. No.: **29/475,379**

**DESCRIPTION**

(22) Filed: **Dec. 3, 2013**

(51) **LOC (10) Cl.** ..... **12-16**

(52) **U.S. Cl.**  
USPC ..... **D12/163**

(58) **Field of Classification Search**  
USPC ..... D12/163, 196, 86, 90-92, 171, 169,  
D12/216; 180/68.1, 68.6; 293/193.11  
See application file for complete search history.

FIG. 1 is a top plan view of a vehicle front bumper lower grille;  
FIG. 2 is a bottom plan view thereof;  
FIG. 3 is a front elevational view thereof  
FIG. 4 is a left side elevational view thereof;  
FIG. 5 is a right side elevational view thereof;  
FIG. 6 is a bottom left side perspective view thereof; and,  
FIG. 7 is a bottom right side perspective view thereof.

**1 Claim, 7 Drawing Sheets**

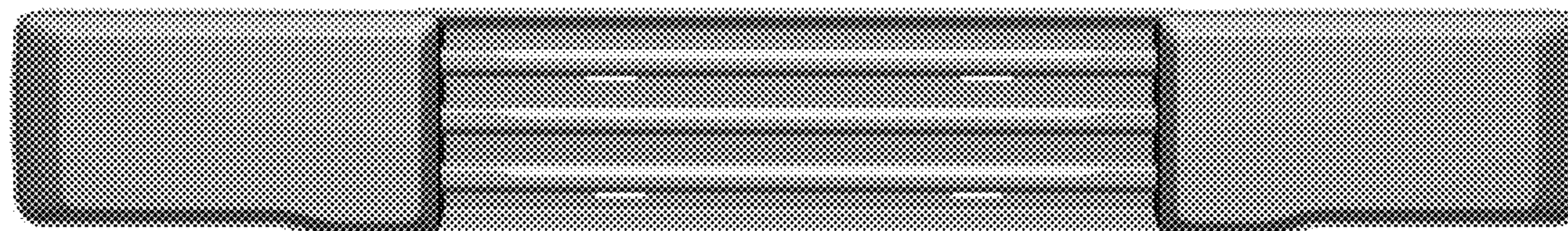

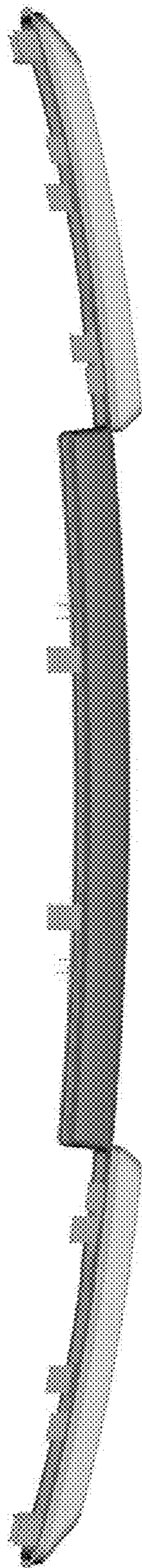

Figure 1

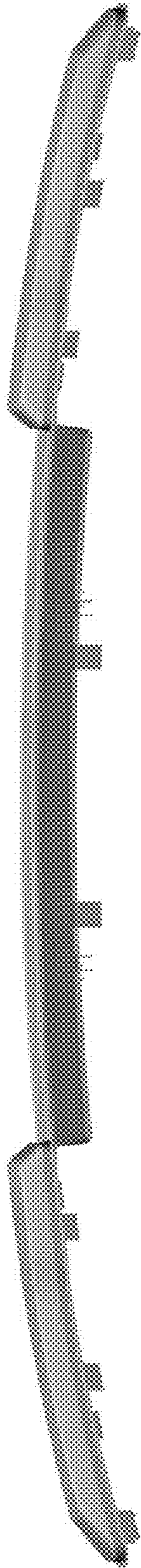

Figure 2

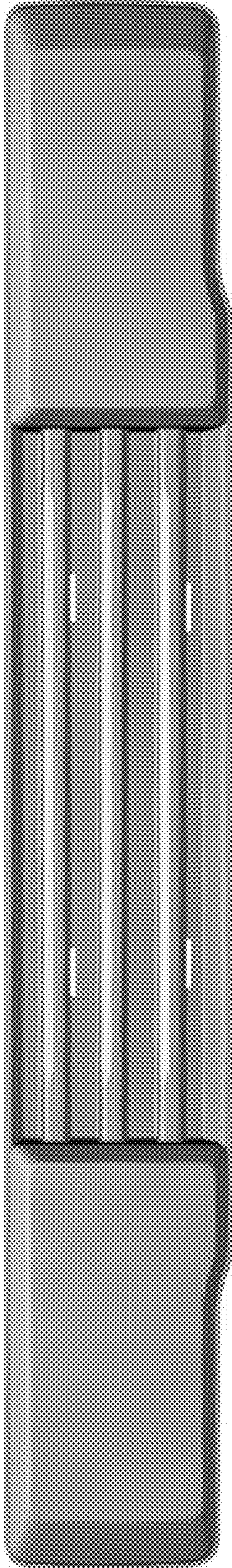

Figure 3

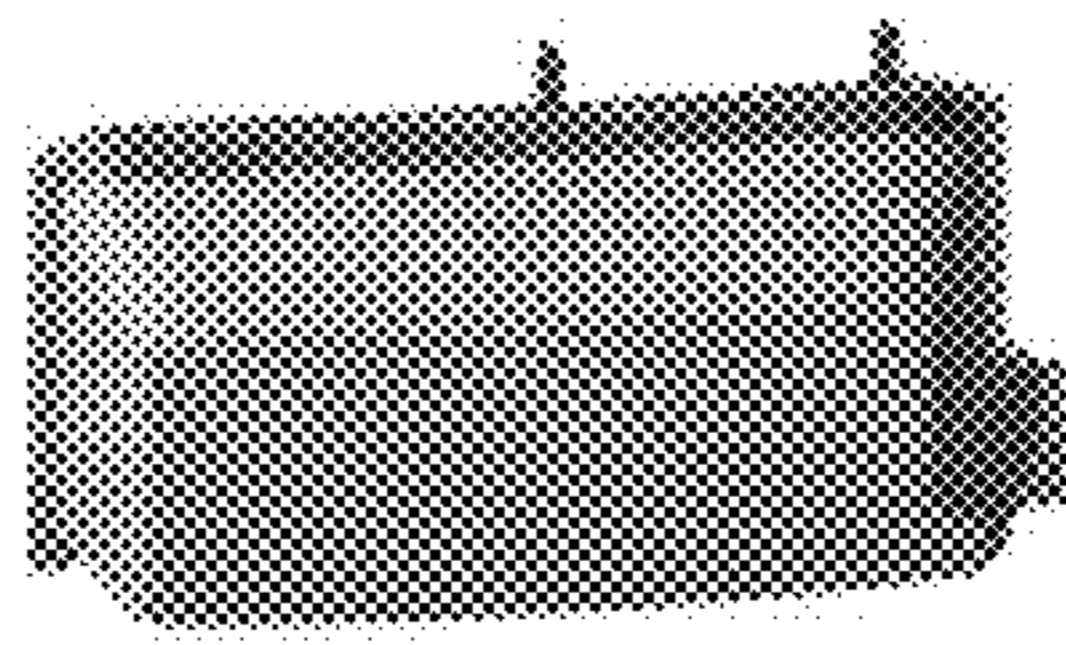

Figure 4

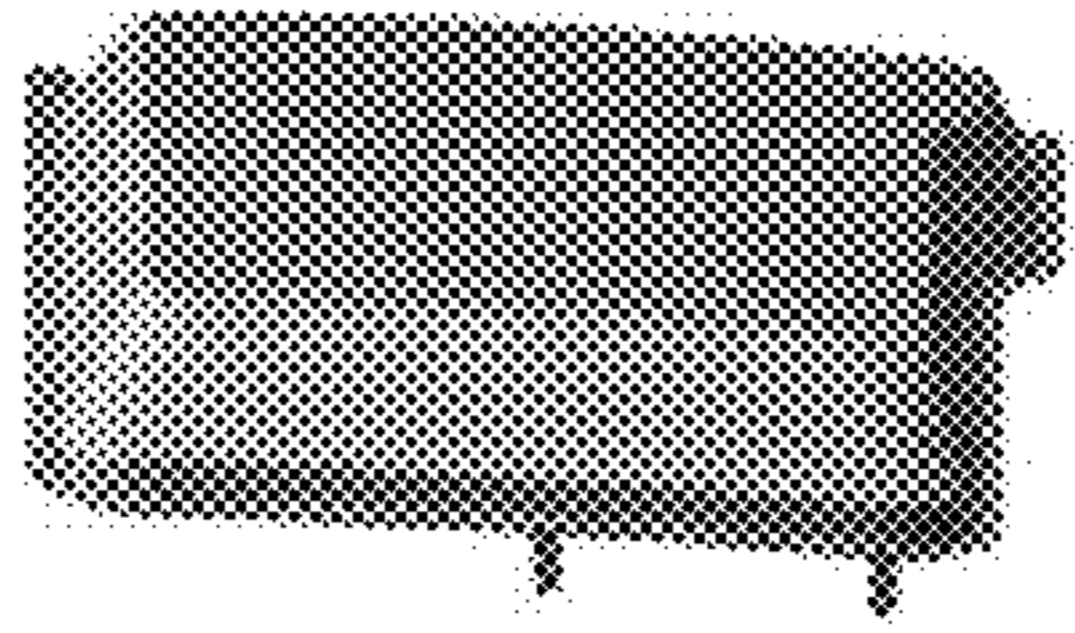

Figure 5

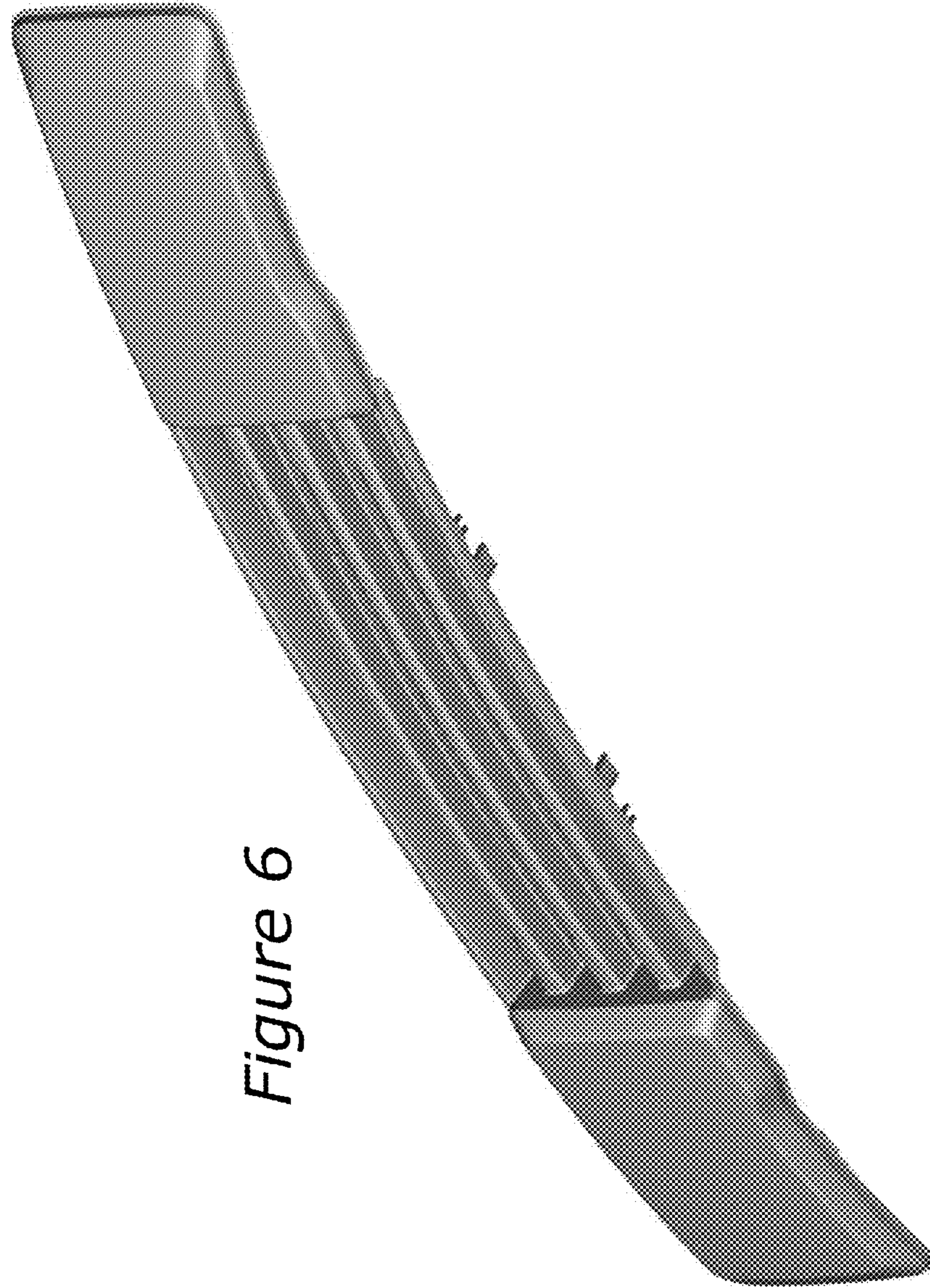

Figure 6

Figure 7

