



US00D720616S

(12) **United States Design Patent**
Lam

(10) **Patent No.:** **US D720,616 S**

(45) **Date of Patent:** **** Jan. 6, 2015**

(54) **LID**

(71) Applicant: **Starbucks Corporation**, Seattle, WA
(US)

(72) Inventor: **Amy Lam**, Sammamish, WA (US)

(73) Assignee: **Starbucks Corporation**, Seattle, WA
(US)

(**) Term: **14 Years**

(21) Appl. No.: **29/478,640**

(22) Filed: **Jan. 7, 2014**

(51) **LOC (10) Cl.** **09-07**

(52) **U.S. Cl.**
USPC **D9/447**

(58) **Field of Classification Search**
USPC D6/452-545; D7/300, 321, 392.1,
D7/396.2, 500, 507, 509, 510, 511, 900;
D9/434-448, 452-455, 682, 685, 694;
215/200, 235, 236, 252, 254, 329,
215/355-364; 220/203.04-203.07, 220,
220/254.1, 254.4, 556, 703, 704, 705
See application file for complete search history.

(56) **References Cited**

U.S. PATENT DOCUMENTS

D369,109 S	*	4/1996	Proshan	D9/447
D417,845 S	*	12/1999	Sadlier et al.	D9/447
D516,424 S	*	3/2006	Schweigert et al.	D9/447
D591,595 S	*	5/2009	Tedford, Jr.	D9/447
D649,878 S	*	12/2011	Weiss	D9/447
D658,057 S	*	4/2012	Donat	D9/447
D660,696 S	*	5/2012	Weiss	D9/447
D664,001 S	*	7/2012	Liu	D7/510
D666,490 S	*	9/2012	Leon	D9/447

D672,610 S	*	12/2012	Park et al.	D7/510
D675,524 S	*	2/2013	Bickert et al.	D9/447
2006/0071008 A1	*	4/2006	Sadlier	220/713

* cited by examiner

Primary Examiner — Robert M Spear

Assistant Examiner — Marissa J Cash

(74) *Attorney, Agent, or Firm* — Knobbe Martens Olson & Bear LLP

(57) **CLAIM**

The ornamental design for a lid, as shown and described herein.

DESCRIPTION

FIG. 1 is a top perspective view of a lid showing a first embodiment of our design;

FIG. 2 is a front view of the first embodiment;

FIG. 3 is a right-side view of the first embodiment;

FIG. 4 is a rear-side view of the first embodiment;

FIG. 5 is a left-side view of the first embodiment;

FIG. 6 is a top plan view of the first embodiment;

FIG. 7 is a bottom view of the first embodiment;

FIG. 8 is a bottom perspective view of the first embodiment;

FIG. 9 is a top perspective view of a lid showing a second embodiment of our design;

FIG. 10 is a front view of the second embodiment;

FIG. 11 is a right-side view of the second embodiment;

FIG. 12 is a rear-side view of the second embodiment;

FIG. 13 is a left-side view of the second embodiment;

FIG. 14 is a top plan view of the second embodiment;

FIG. 15 is a bottom view of the second embodiment; and,

FIG. 16 is a bottom perspective view of the second embodiment.

All features in broken lines are for the purpose of illustrating environmental structure and form no part of the claimed design.

1 Claim, 16 Drawing Sheets

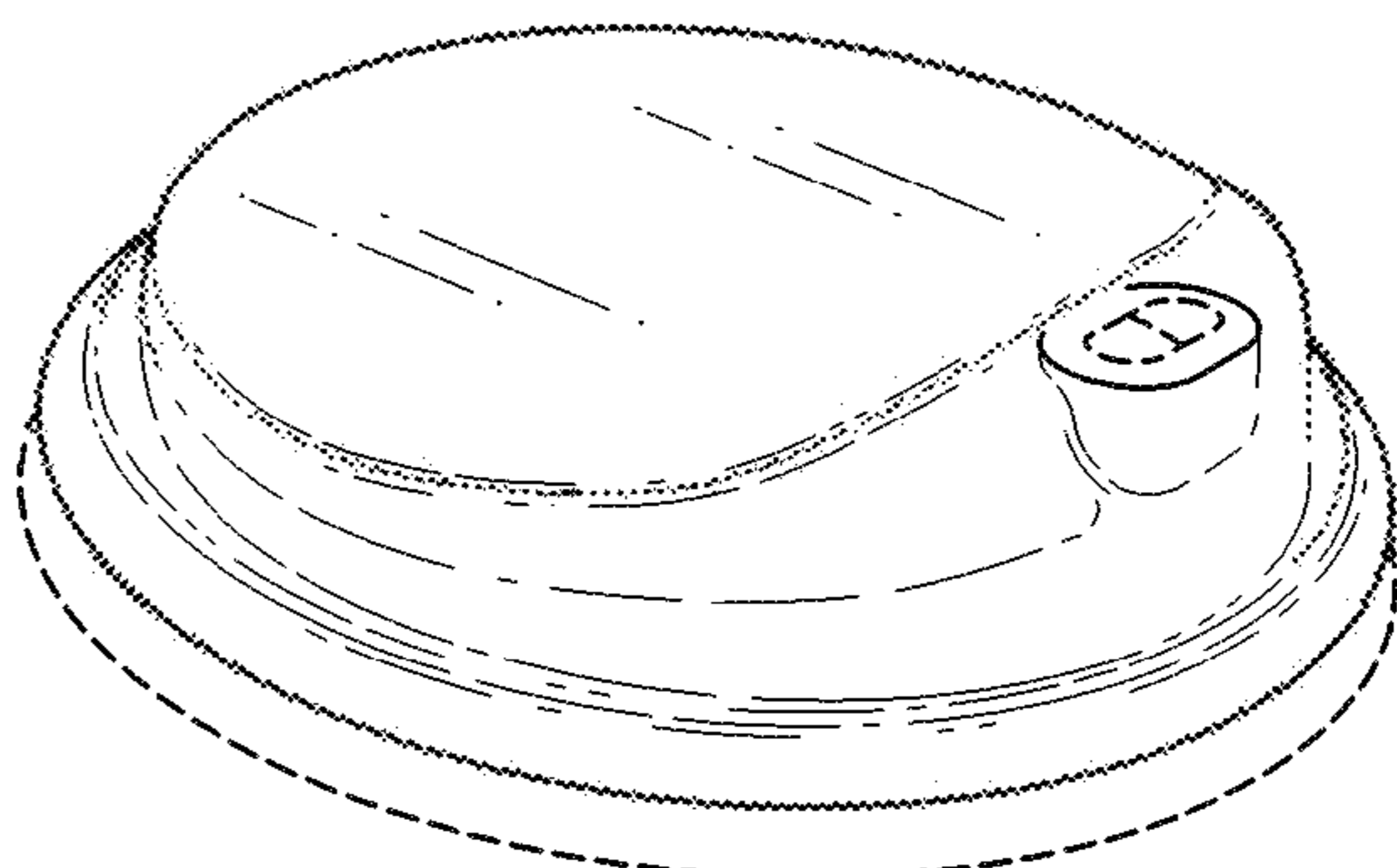
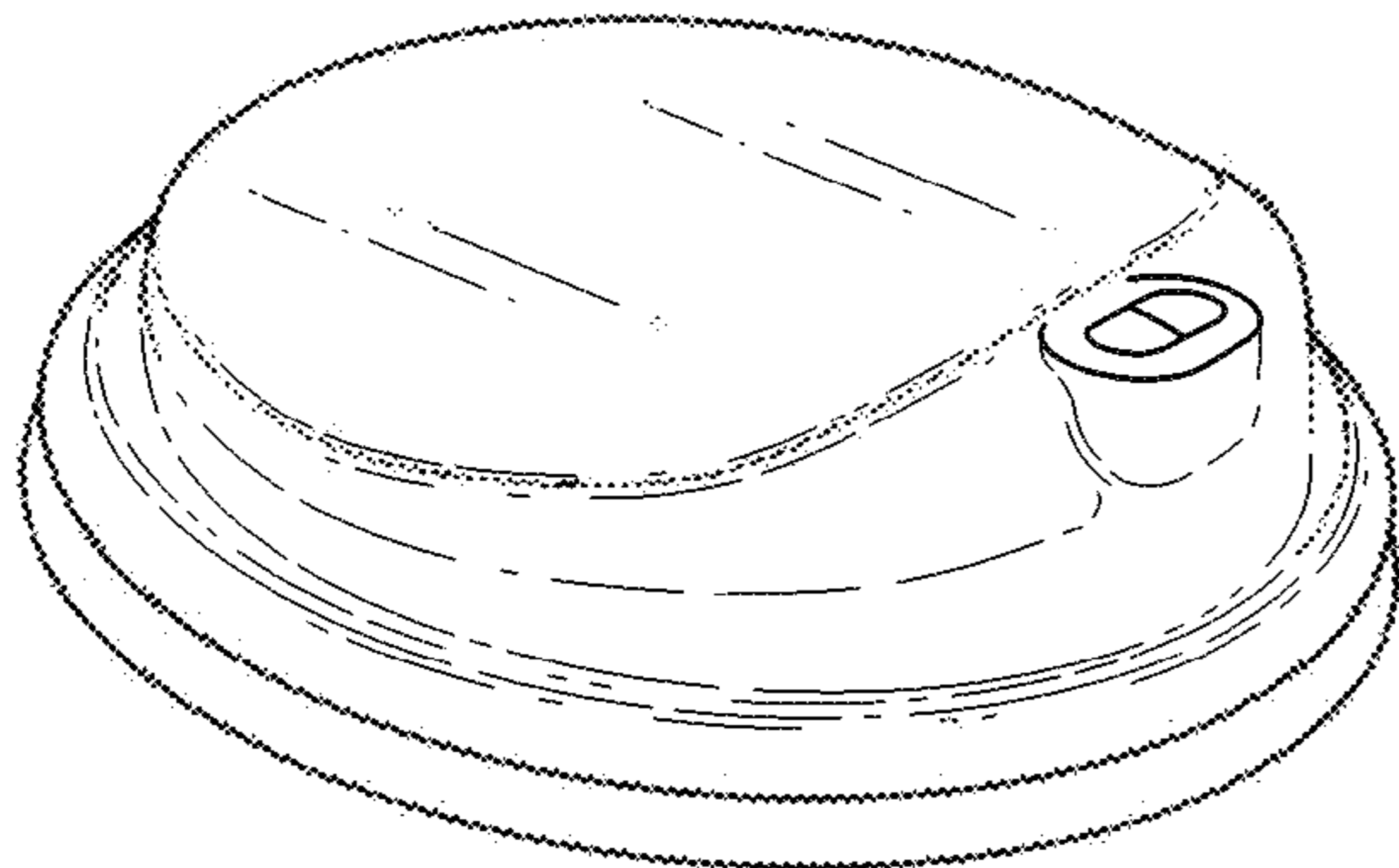

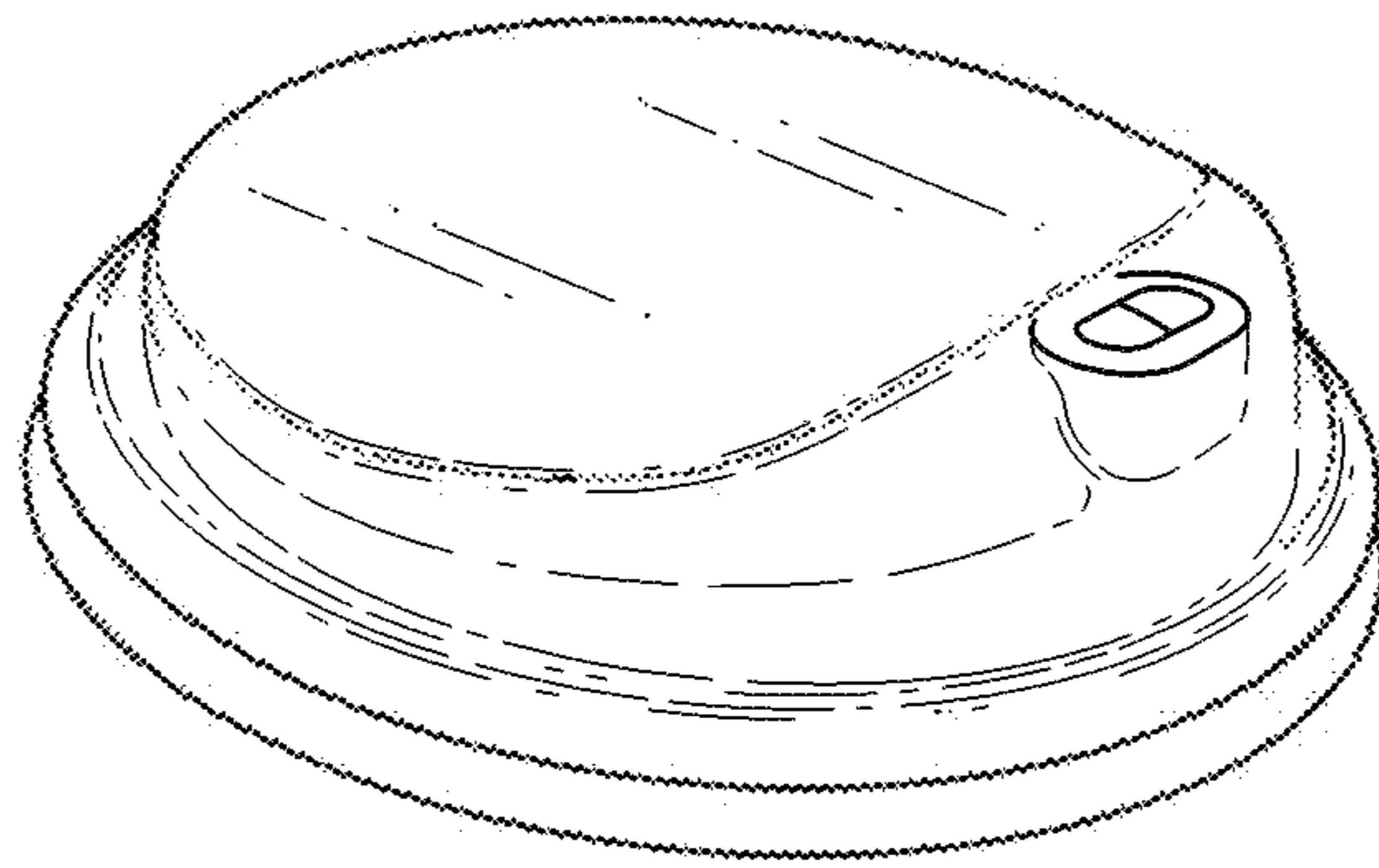

FIG. 1

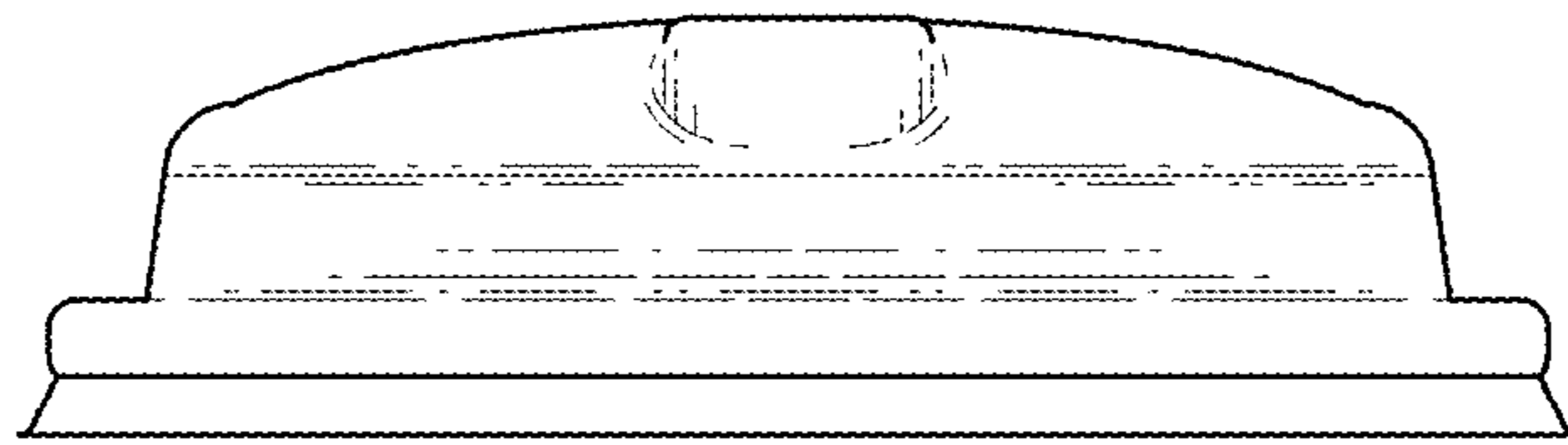

FIG. 2

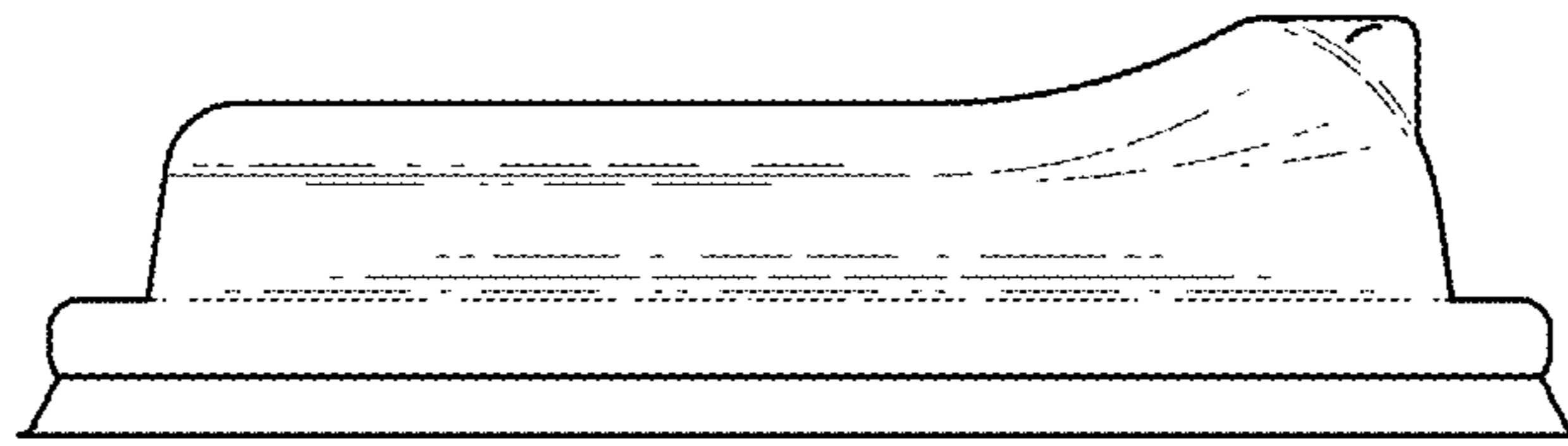

FIG. 3

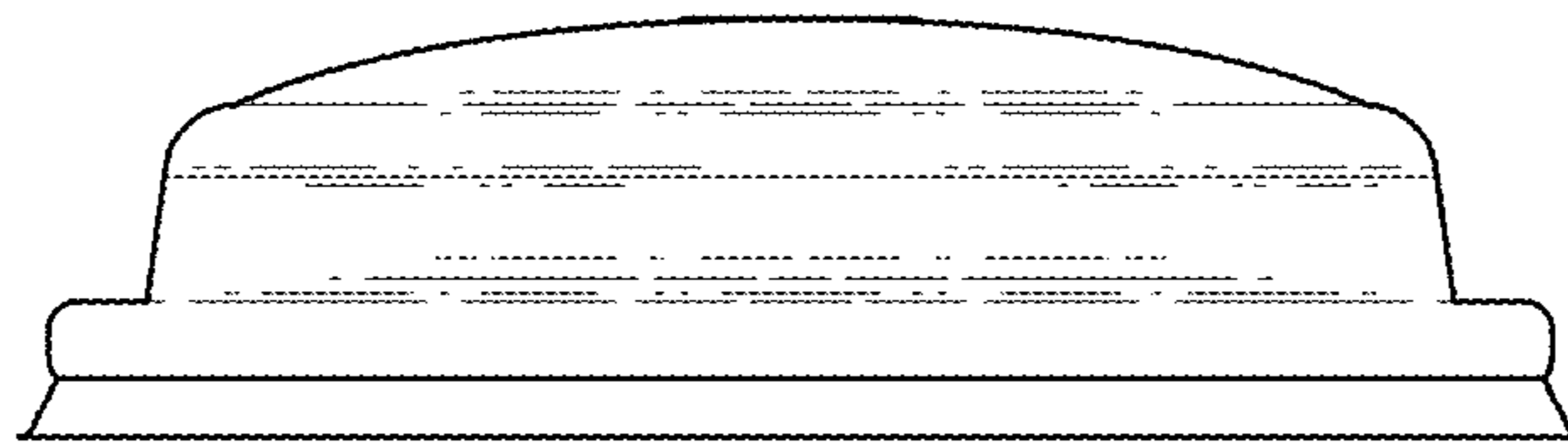

FIG. 4

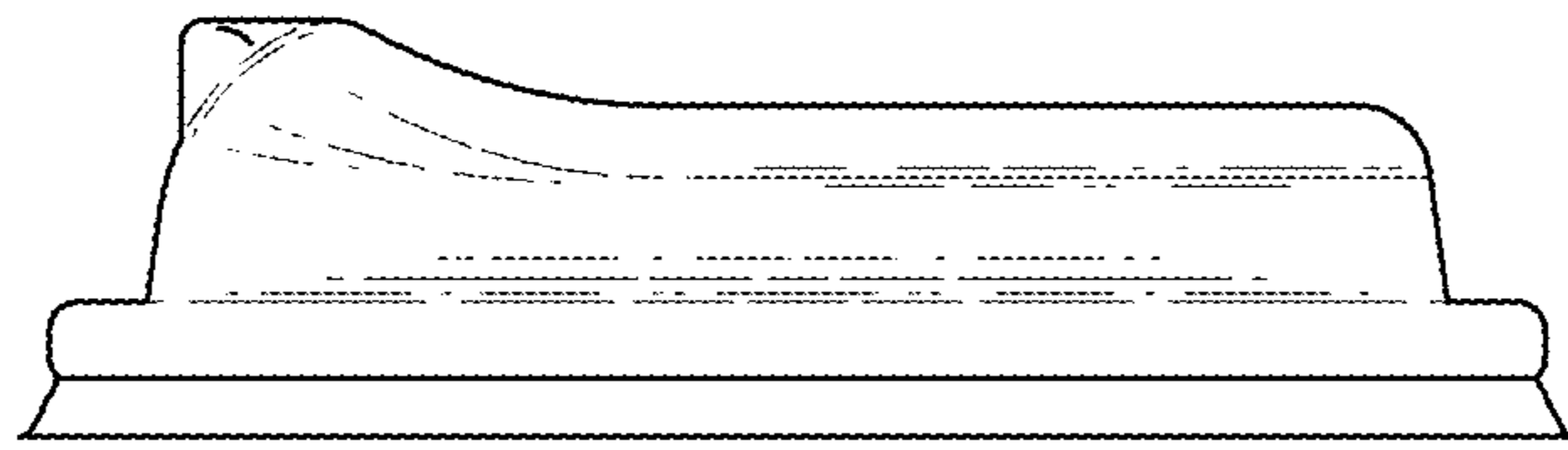

FIG. 5

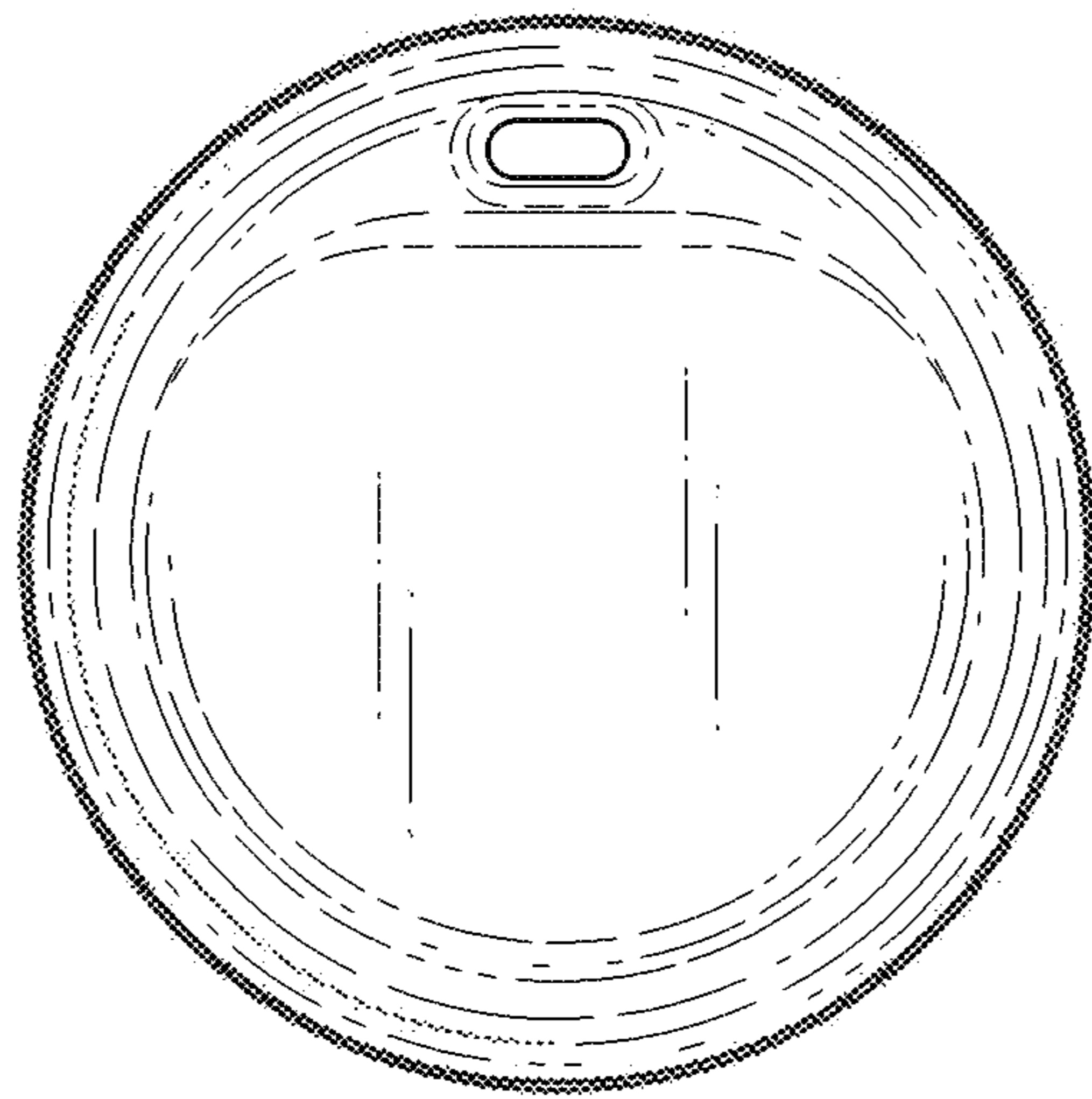

FIG. 6

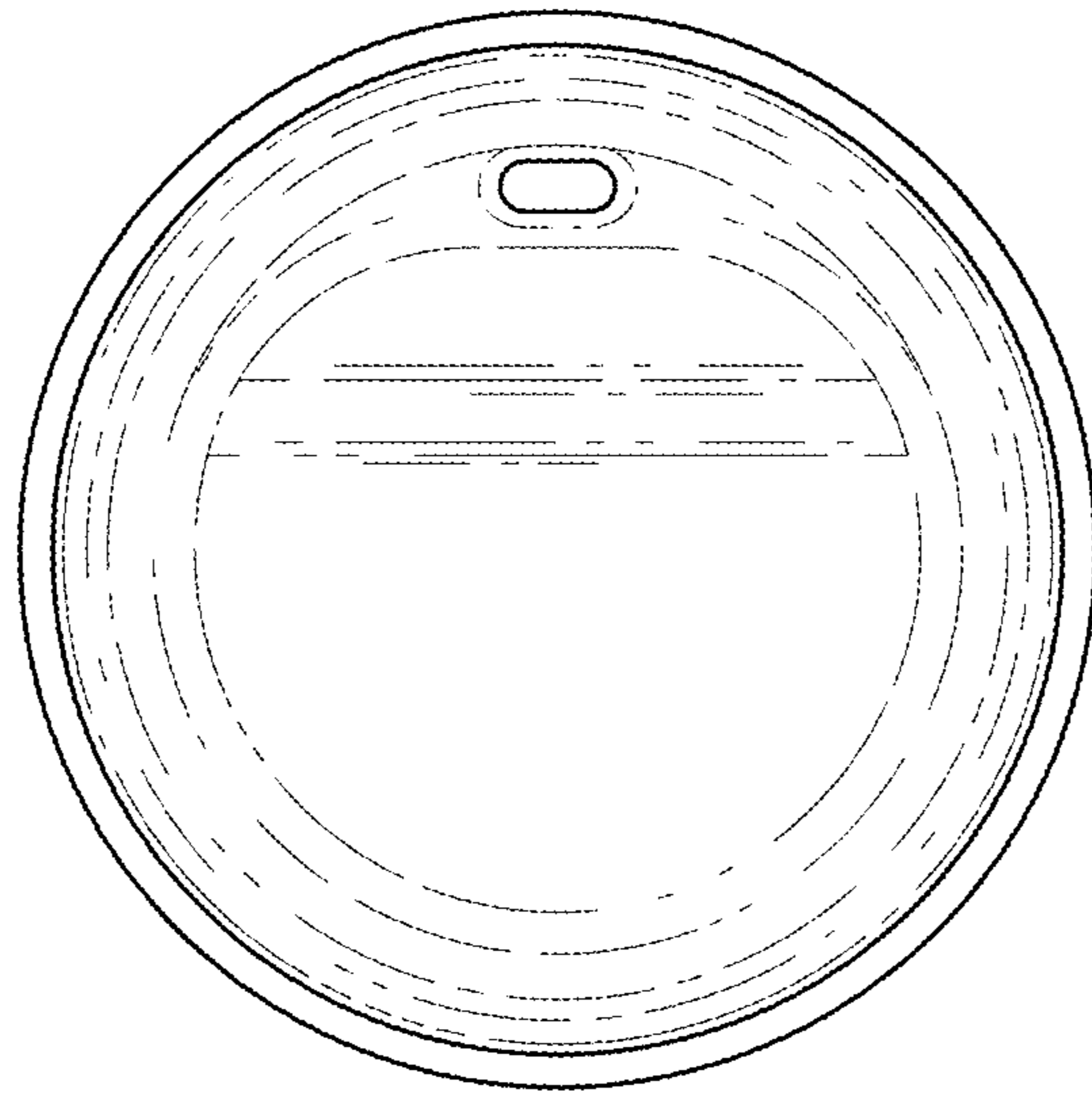

FIG. 7

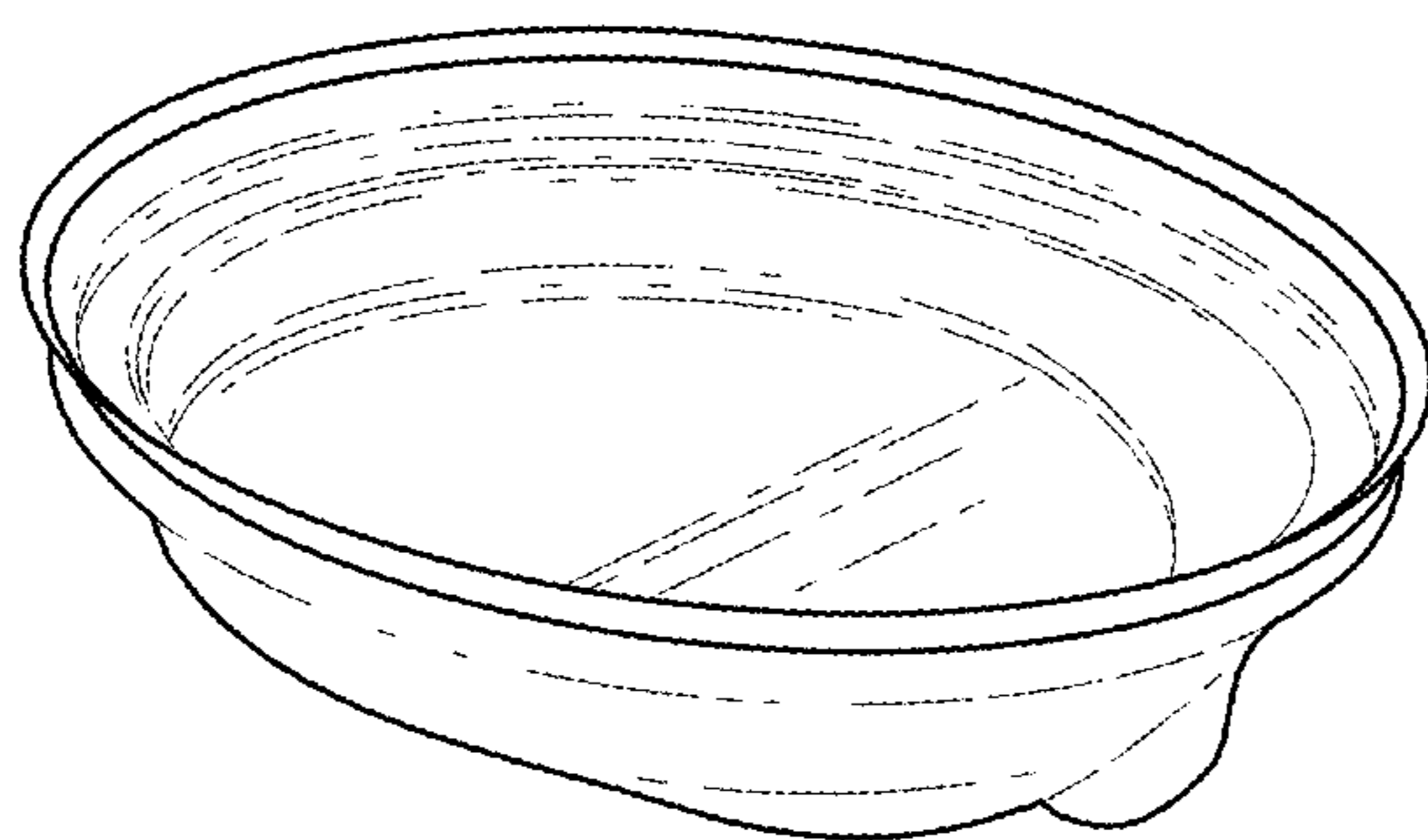

FIG. 8

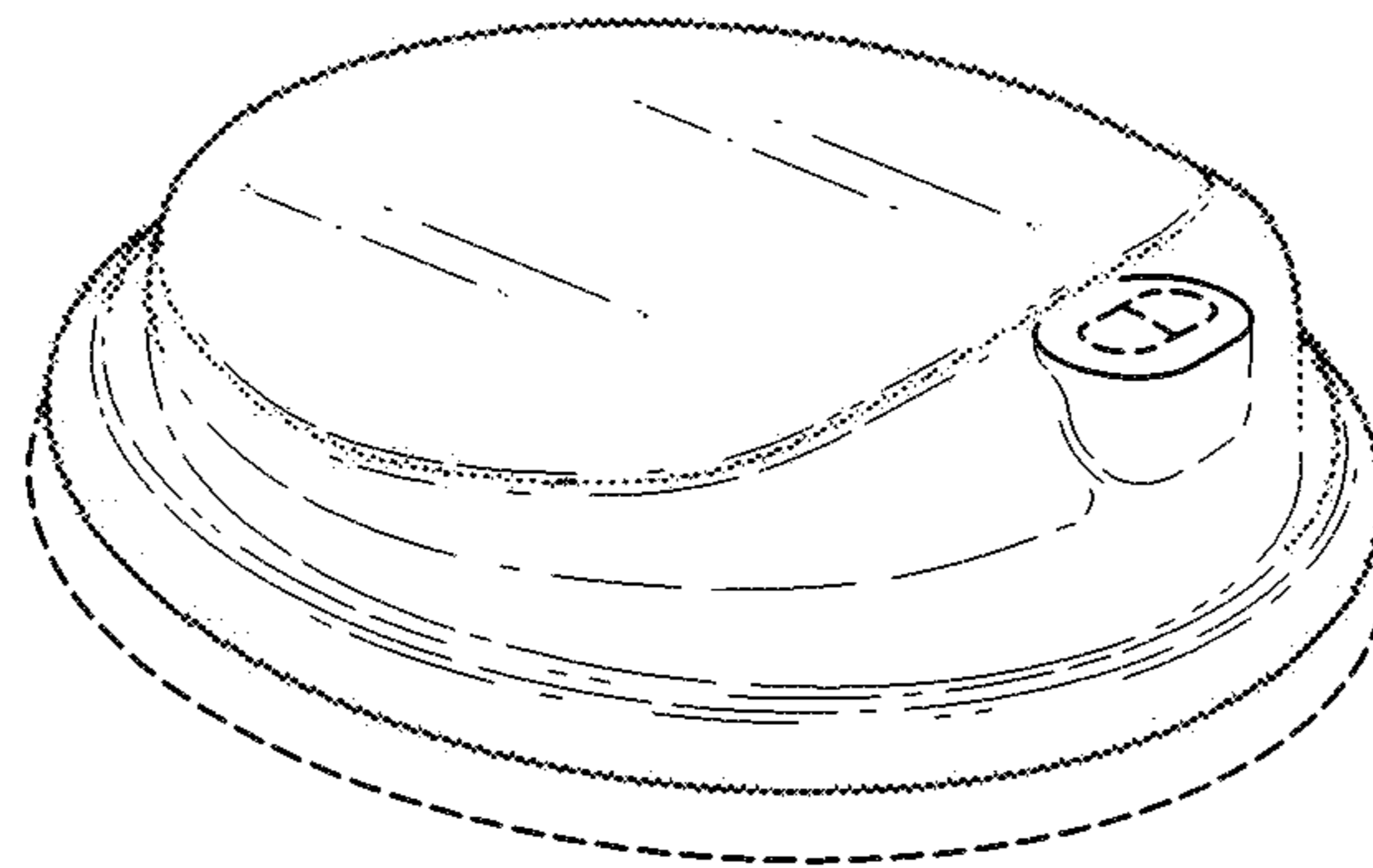

FIG. 9

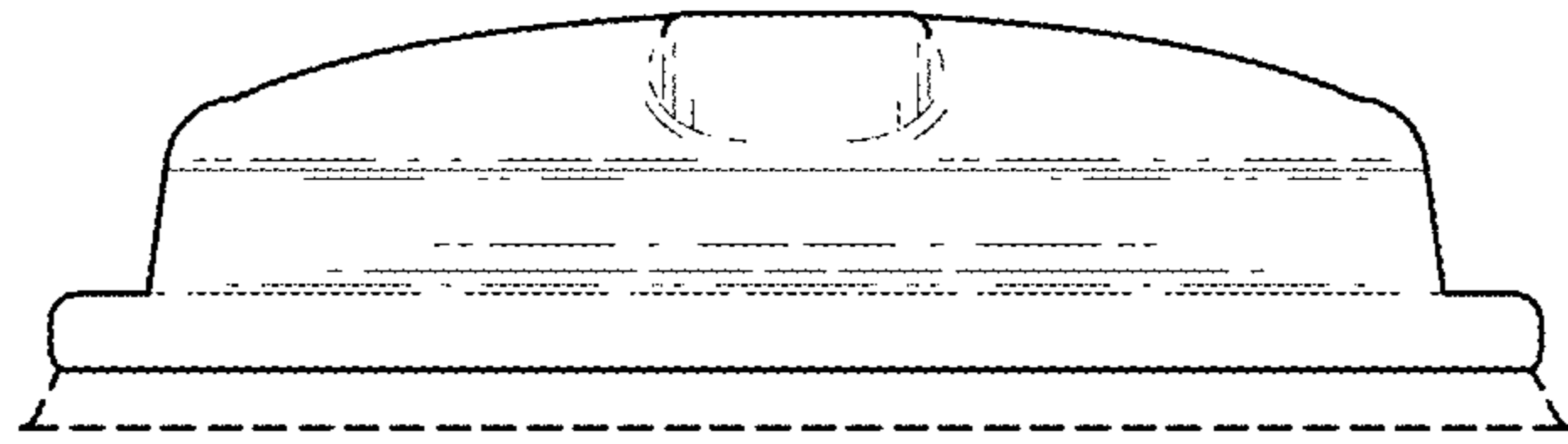

FIG. 10

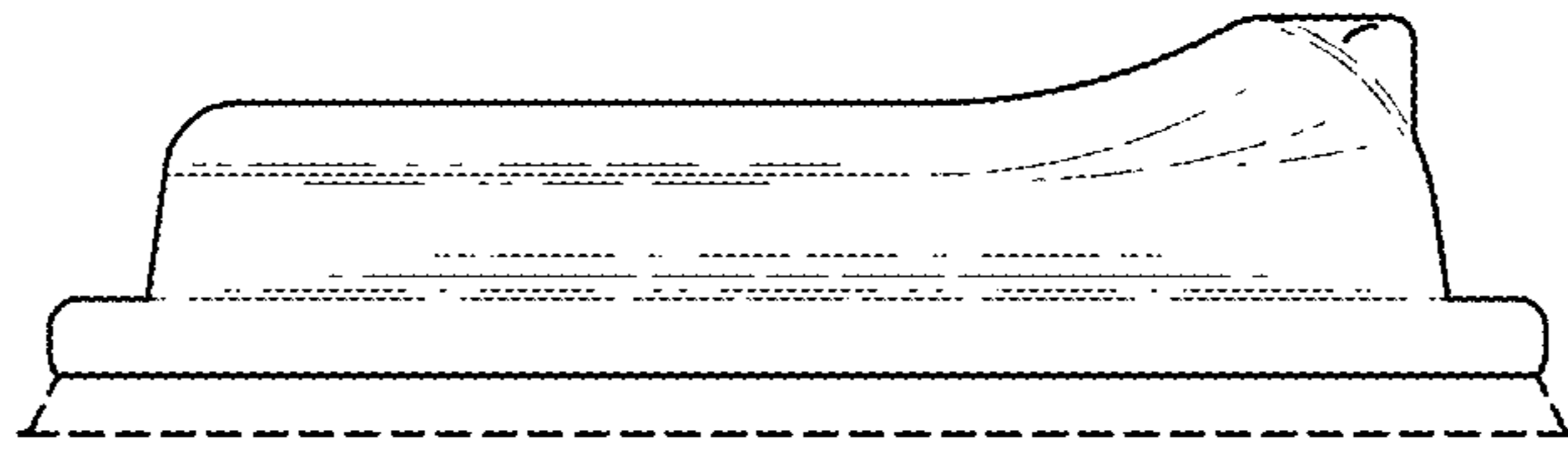

FIG. 11

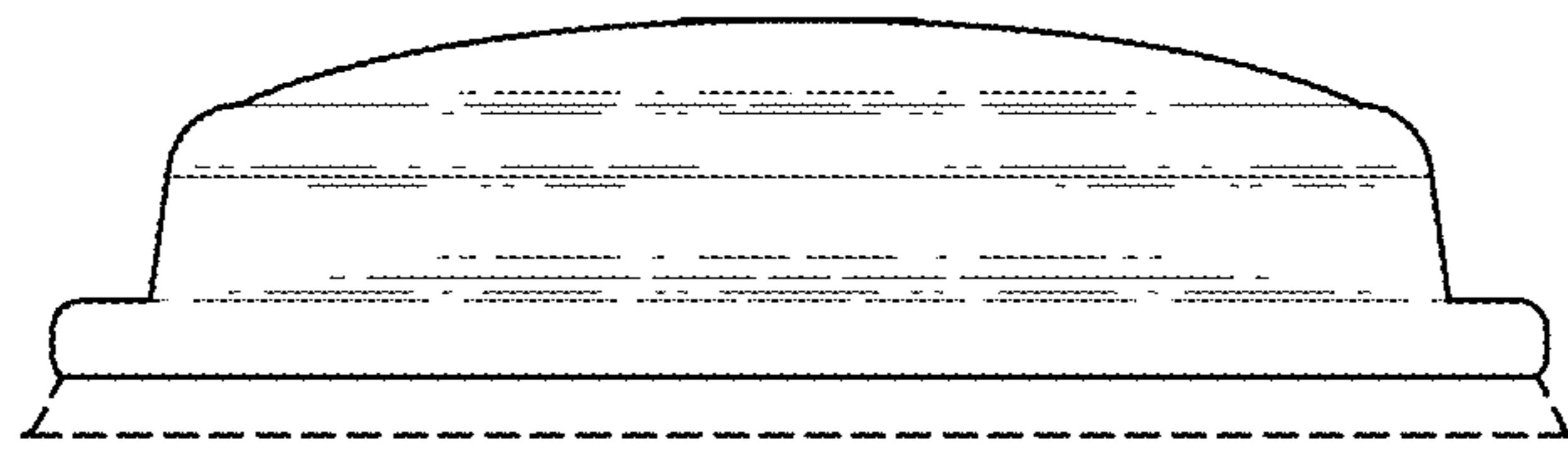

FIG. 12

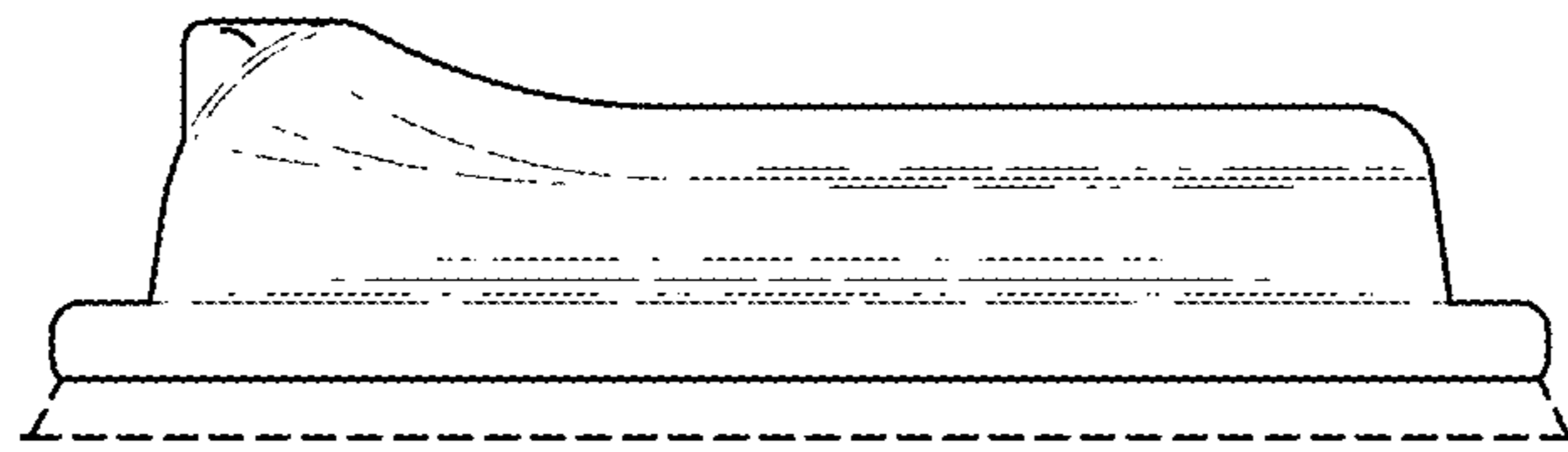

FIG. 13

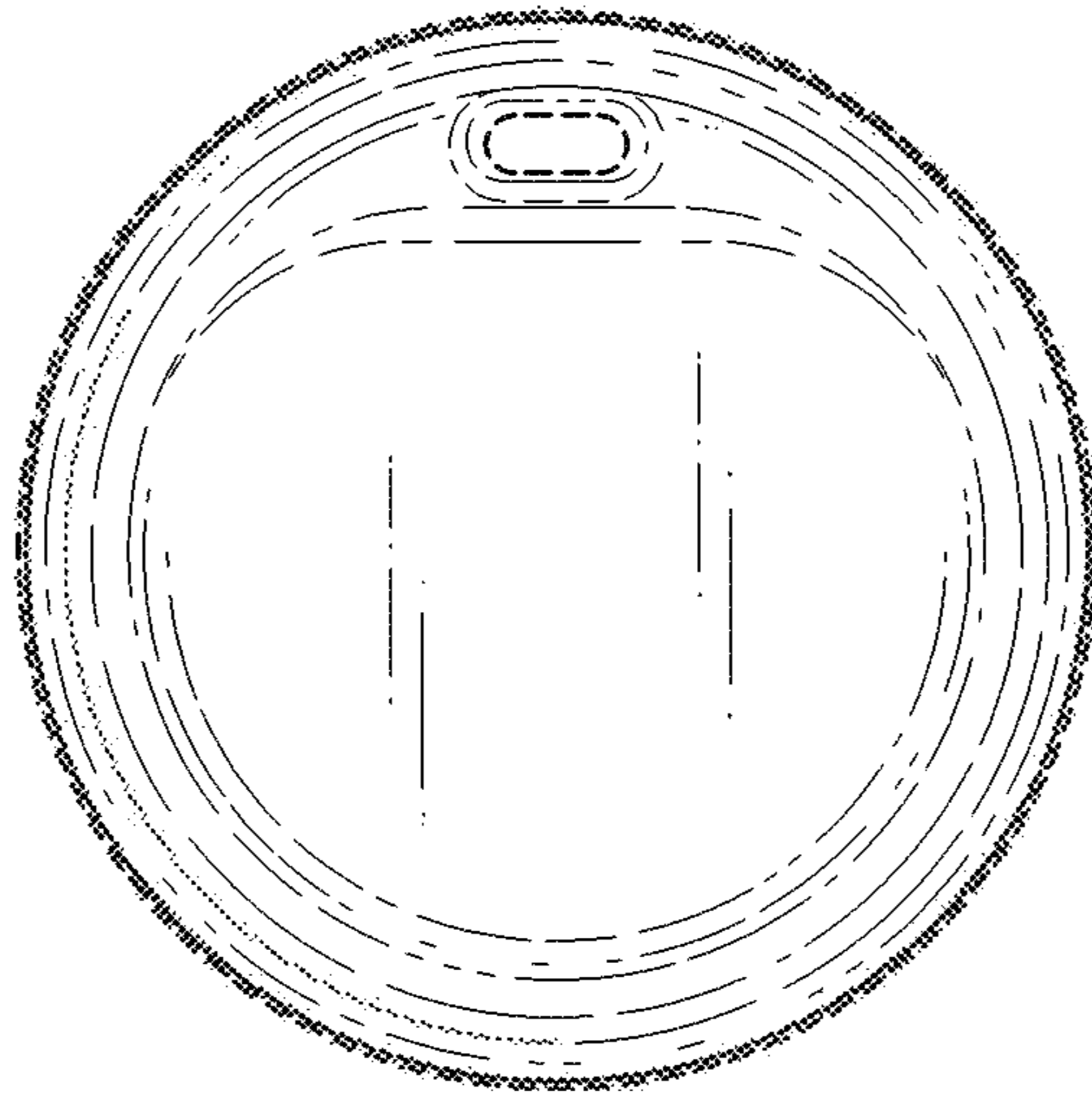

FIG. 14

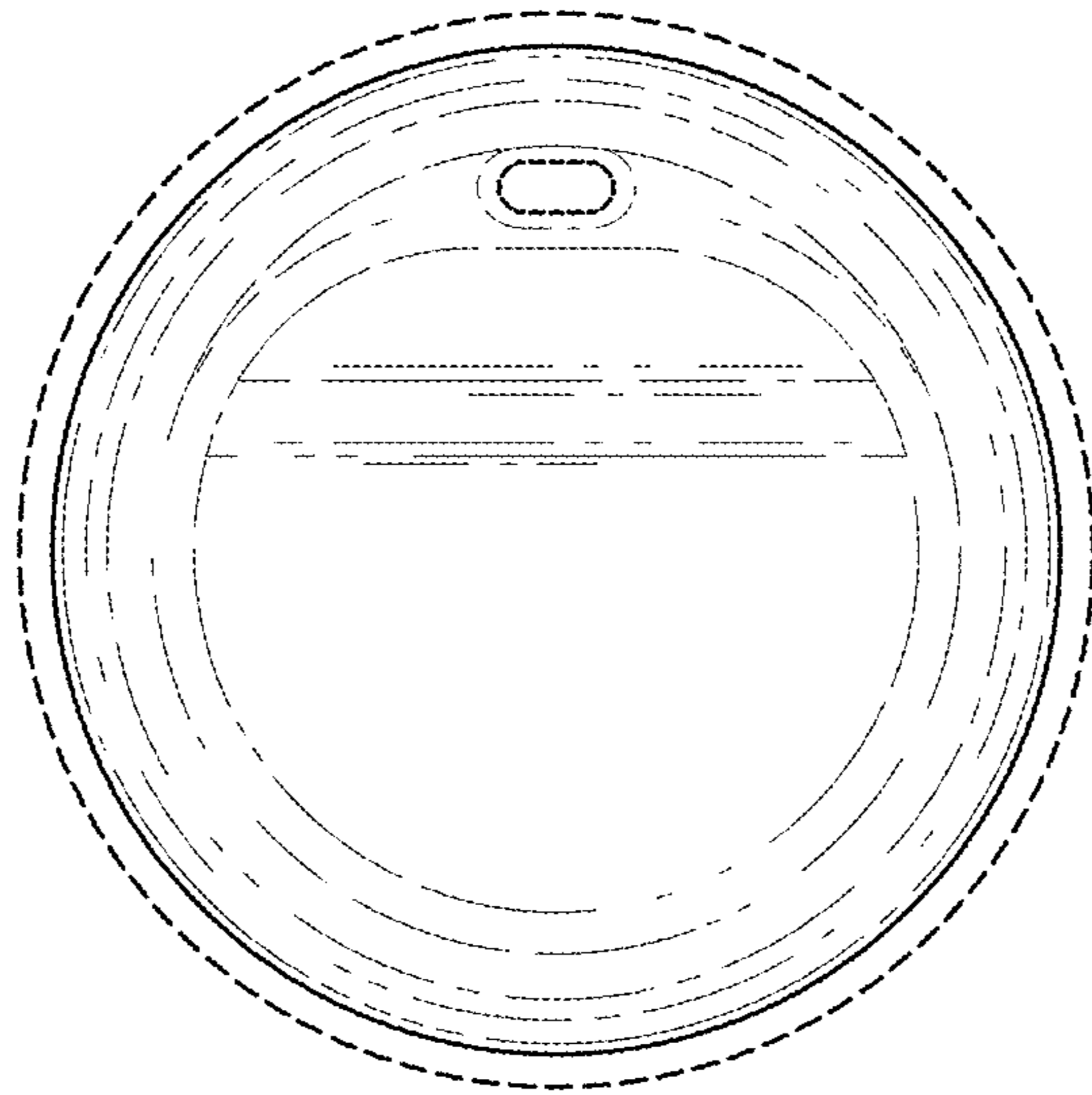

FIG. 15

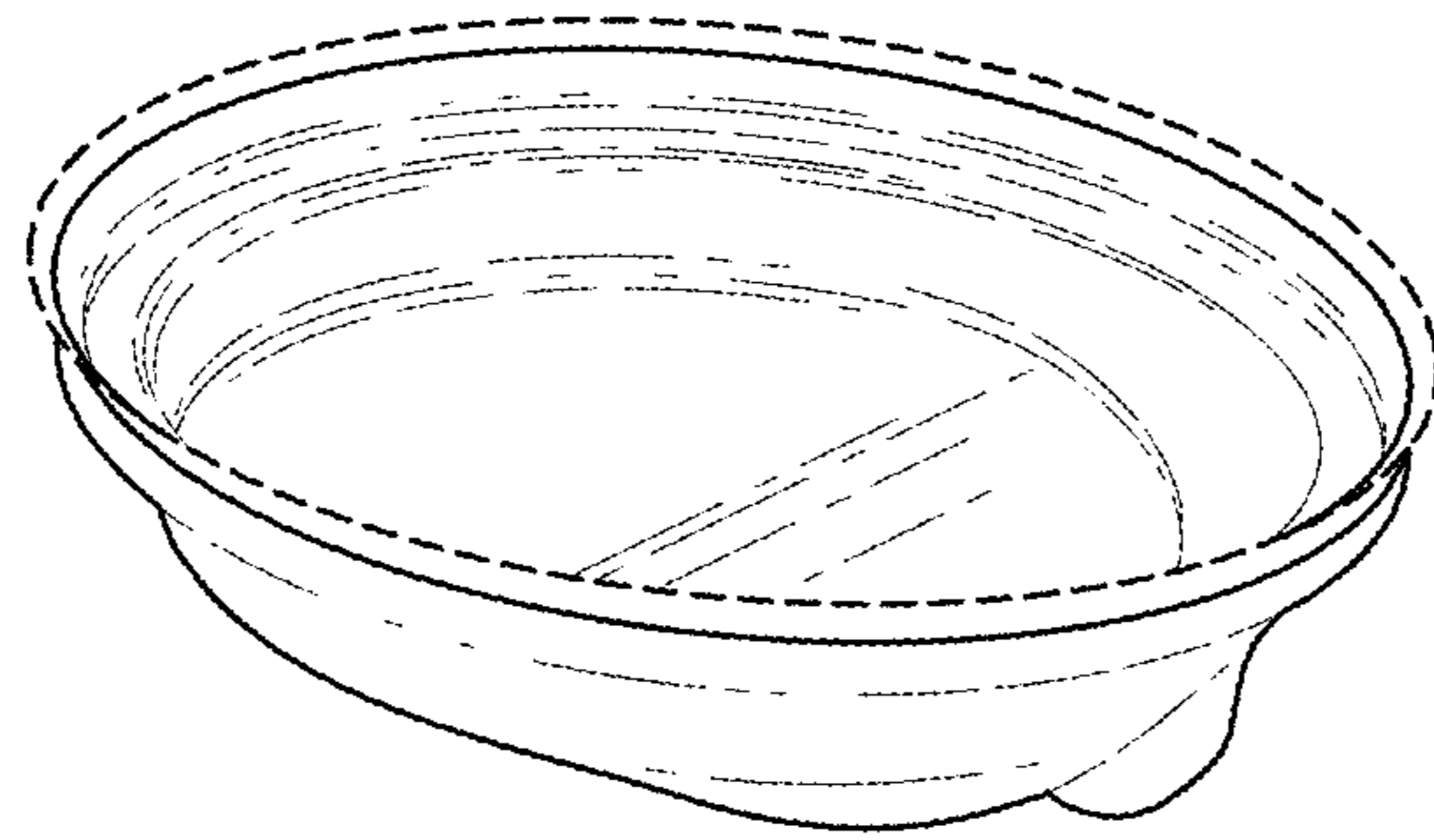

FIG. 16