



US00D720607S

(12) **United States Design Patent**
Kats

(10) **Patent No.:** **US D720,607 S**
(45) **Date of Patent:** **** Jan. 6, 2015**

(54) **HORIZONTAL FRAME MEMBER FOR SUPPORTING A CONCENTRATING PHOTOVOLTAIC SYSTEM MODULE**

(71) Applicant: **Suncore Photovoltaics Incorporated**,
Irwindale, CA (US)

(72) Inventor: **Mikhail Kats**, Rockaway, NJ (US)

(73) Assignee: **Suncore Photovoltaics, Inc.**,
Albuquerque, NM (US)

(**) Term: **14 Years**

(21) Appl. No.: **29/444,606**

(22) Filed: **Jan. 31, 2013**

(51) **LOC (10) Cl.** **08-05**

(52) **U.S. Cl.**
USPC **D8/380**

(58) **Field of Classification Search**
USPC D8/380, 349, 354, 381, 373, 367, 355,
D8/363, 382, 374, 339, 376, 398; 119/705;
52/4, 260, 649.1, 649.2, 296; D6/702,
D6/550, 310; D23/259; 482/16; D12/160;
D25/133; D14/238, 251, 447, 253;
224/250, 269, 901.4, 930, 242, 246,
224/669; 248/59, 62, 58, 68.1, 295.11;
D7/701; D3/218, 220

See application file for complete search history.

(56) **References Cited**

U.S. PATENT DOCUMENTS

D357,398 S * 4/1995 Osbern D8/349
D423,910 S * 5/2000 Cyrell D8/349
D530,595 S * 10/2006 Lam et al. D8/373
D538,140 S * 3/2007 Ly Hau et al. D8/373

D538,141 S * 3/2007 Stenhouse et al. D8/373
D539,125 S * 3/2007 Ly Hau et al. D8/373
D539,126 S * 3/2007 Stenhouse et al. D8/373
D539,128 S * 3/2007 Ly Hau et al. D8/373
D539,637 S * 4/2007 Ly Hau et al. D8/373
D605,030 S * 12/2009 Kohler D8/381
D610,437 S * 2/2010 Bremmon et al. D8/373
D708,933 S * 7/2014 Kats D8/381
D709,750 S * 7/2014 Kats et al. D8/72

* cited by examiner

Primary Examiner — Robert M Spear

Assistant Examiner — Eliza Bennett-Hattan

(74) *Attorney, Agent, or Firm* — Mueting, Raasch & Gebhardt, P.A.

(57) **CLAIM**

The ornamental design for a horizontal frame member for supporting a concentrating photovoltaic system module, as shown and described.

DESCRIPTION

FIG. 1 is a top perspective view of a horizontal frame member for supporting a concentrating photovoltaic system module; FIG. 2 is a front side elevation view of the horizontal frame member of FIG. 1; FIG. 3 is a rear side elevation view of the horizontal frame member of FIG. 1; FIG. 4 is a top plan view of the horizontal frame member of FIG. 1; FIG. 5 is a bottom plan view of the horizontal frame member of FIG. 1; FIG. 6 is a right side elevation view of the horizontal frame member of FIG. 1; and, FIG. 7 is a left side elevation view of the horizontal frame member of FIG. 1.

1 Claim, 5 Drawing Sheets

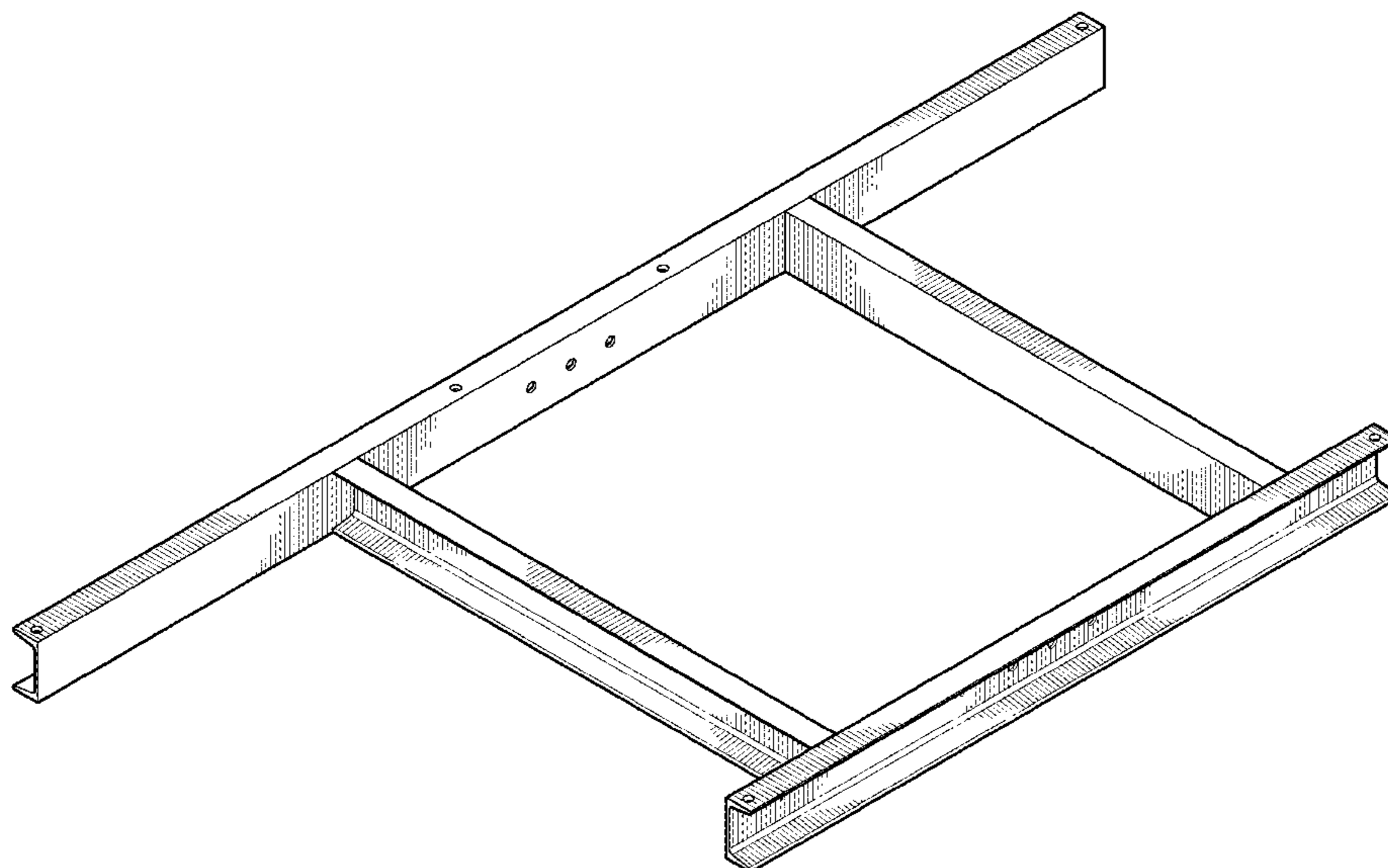

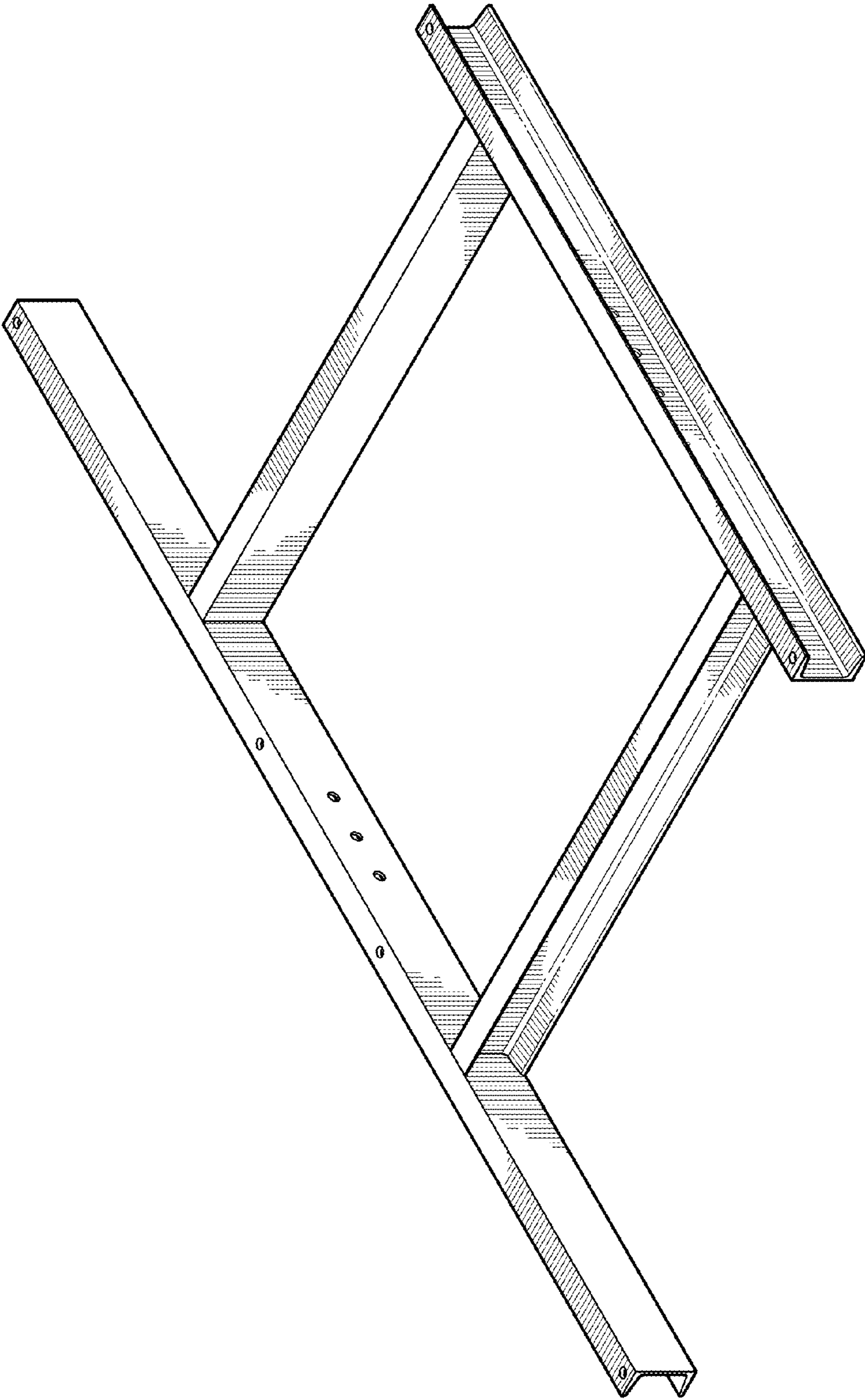

FIG. 1

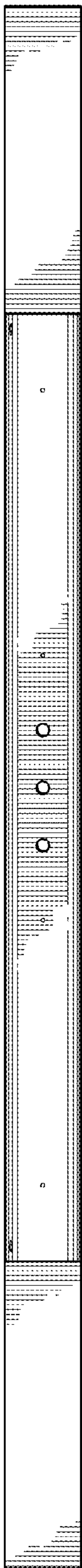

FIG. 2

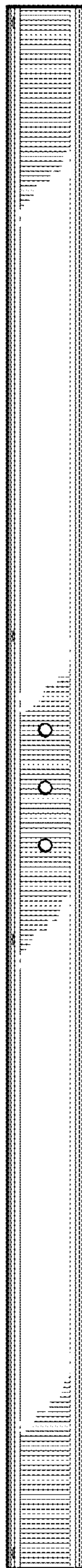

FIG. 3

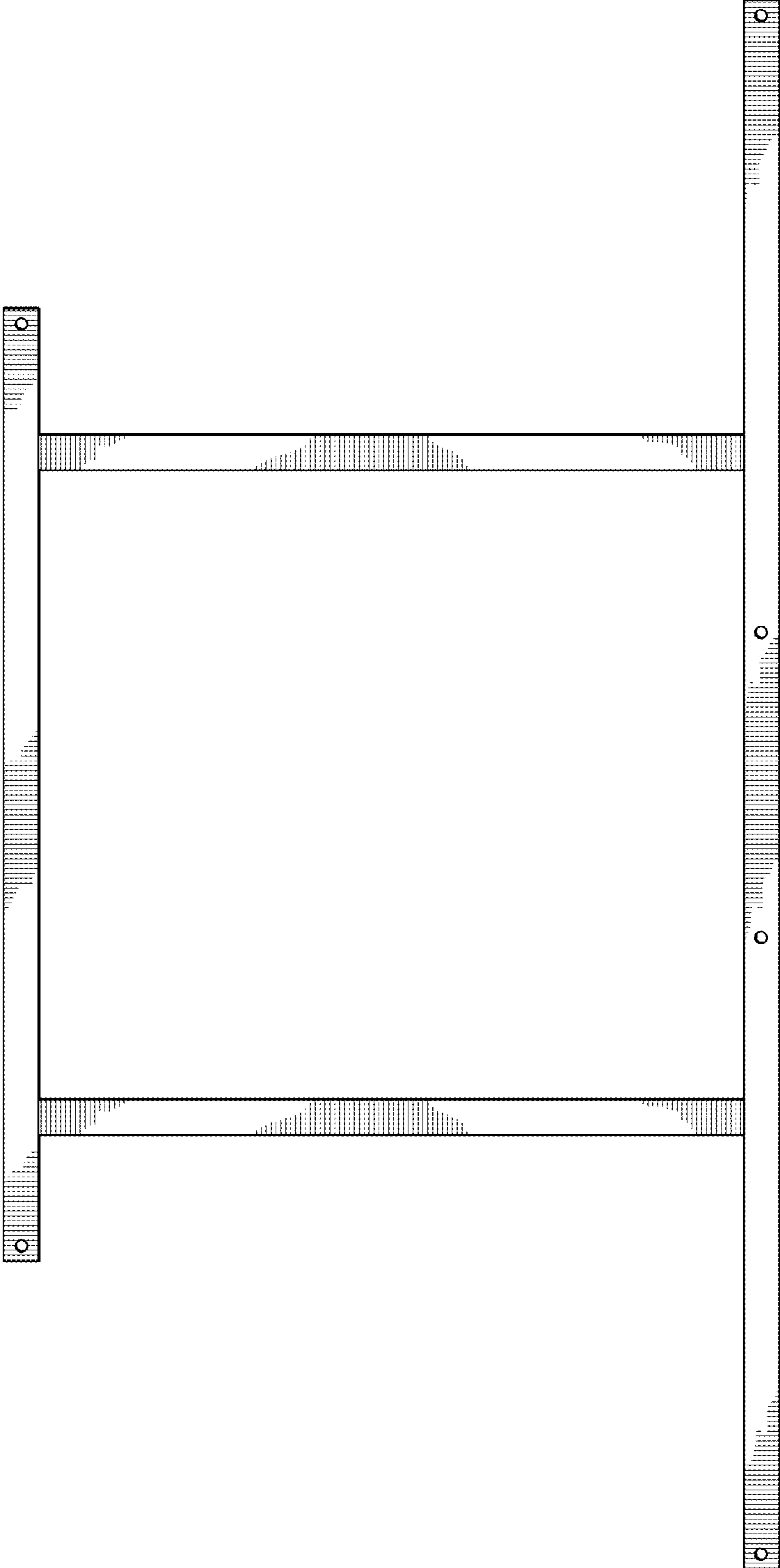

FIG. 4

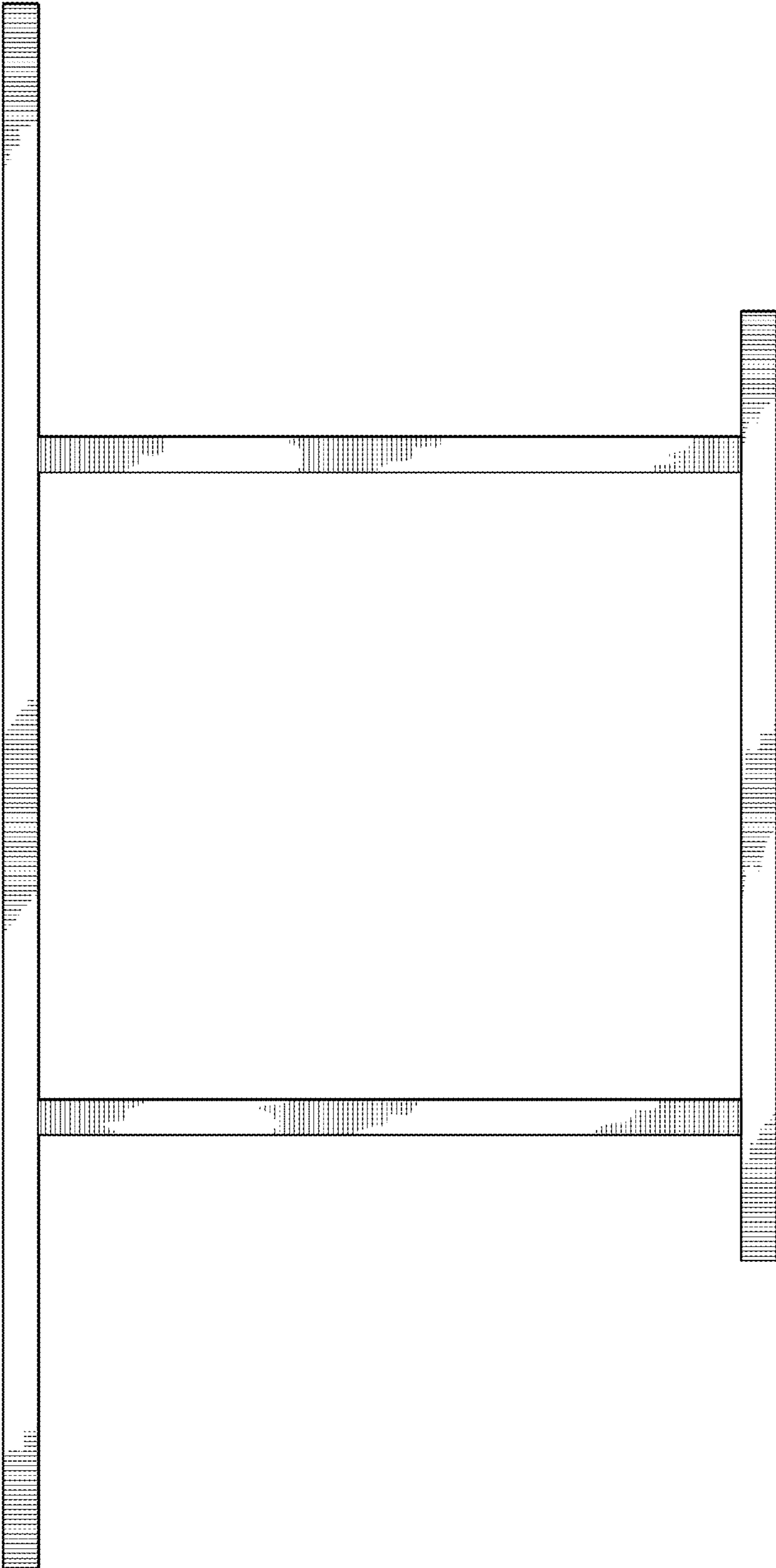

FIG. 5

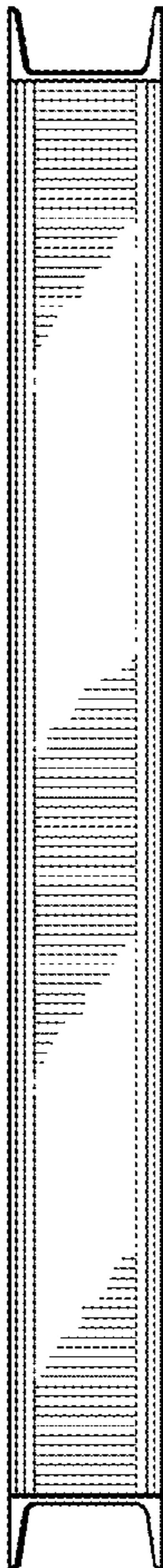

FIG. 6

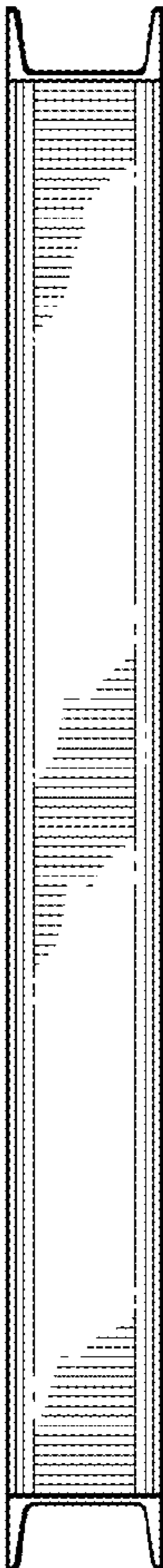

FIG. 7