



US00D720576S

(12) **United States Design Patent**
Dresner

(10) **Patent No.:** **US D720,576 S**
(45) **Date of Patent:** **** *Jan. 6, 2015**

(54) **SLEEVE FOR A BEVERAGE CUP**

- (75) Inventor: **David Andrew Dresner**, Glencoe, IL (US)
- (73) Assignee: **Kymo Enterprises, LLC**, St. Louis, MO (US)
- (*) Notice: This patent is subject to a terminal disclaimer.
- (**) Term: **14 Years**
- (21) Appl. No.: **29/405,357**
- (22) Filed: **Nov. 1, 2011**
- (51) **LOC (10) Cl.** **07-06**
- (52) **U.S. Cl.**
USPC **D7/624.2**
- (58) **Field of Classification Search**
CPC B65D 81/3886
USPC D7/624.2, 624.1, 601, 602, 619.1-625, D7/605, 606, 607, 608, 624.3; D9/438, D9/444, 434; 220/737-739, 902, 903, 673; 62/457.1-457.9; 229/400, 402, 403, 229/800, 906.1, 939; 215/12.1, 12.2, 13.1, 215/10; 206/503
See application file for complete search history.

(56) **References Cited**

U.S. PATENT DOCUMENTS

- 449,119 A * 3/1891 Hall 215/12.1
- 3,138,371 A * 6/1964 Feher et al. 366/341
- 5,205,473 A 4/1993 Coffin, Sr.

(Continued)

FOREIGN PATENT DOCUMENTS

- CA 118198 11/2007
- CA 122422 11/2007

(Continued)

OTHER PUBLICATIONS

U.S. Appl. No. 13/250,959, filed Sep. 30, 2011, Dresner.

(Continued)

Primary Examiner — Ian Simmons

Assistant Examiner — Shannon Morgan

(74) *Attorney, Agent, or Firm* — Polsinelli PC

(57) **CLAIM**

The ornamental design for a sleeve for a beverage cup, as shown and described.

DESCRIPTION

FIG. 1 is a top isometric view of the sleeve for a beverage cup; FIG. 2 is a bottom isometric view of the sleeve for a beverage cup; FIG. 3 is a front view of the sleeve for a beverage cup; FIG. 4 is a rear view of the sleeve for a beverage cup; FIG. 5 is a left side view of the sleeve for a beverage cup; FIG. 6 is a right side view of the sleeve for a beverage cup; FIG. 7 is a top view of the sleeve for a beverage cup; FIG. 8 is a bottom view of the sleeve for a beverage cup; FIG. 9 is a front view of the sleeve for a beverage cup in a collapsed position; and, FIG. 10 is a top view of the sleeve for a beverage cup in a collapsed position.

The broken lines in FIGS. 1, 2, 5, and 6 of the sleeve for a beverage cup is for the purpose of illustrating environment, and forms no part of the claimed design.

1 Claim, 5 Drawing Sheets

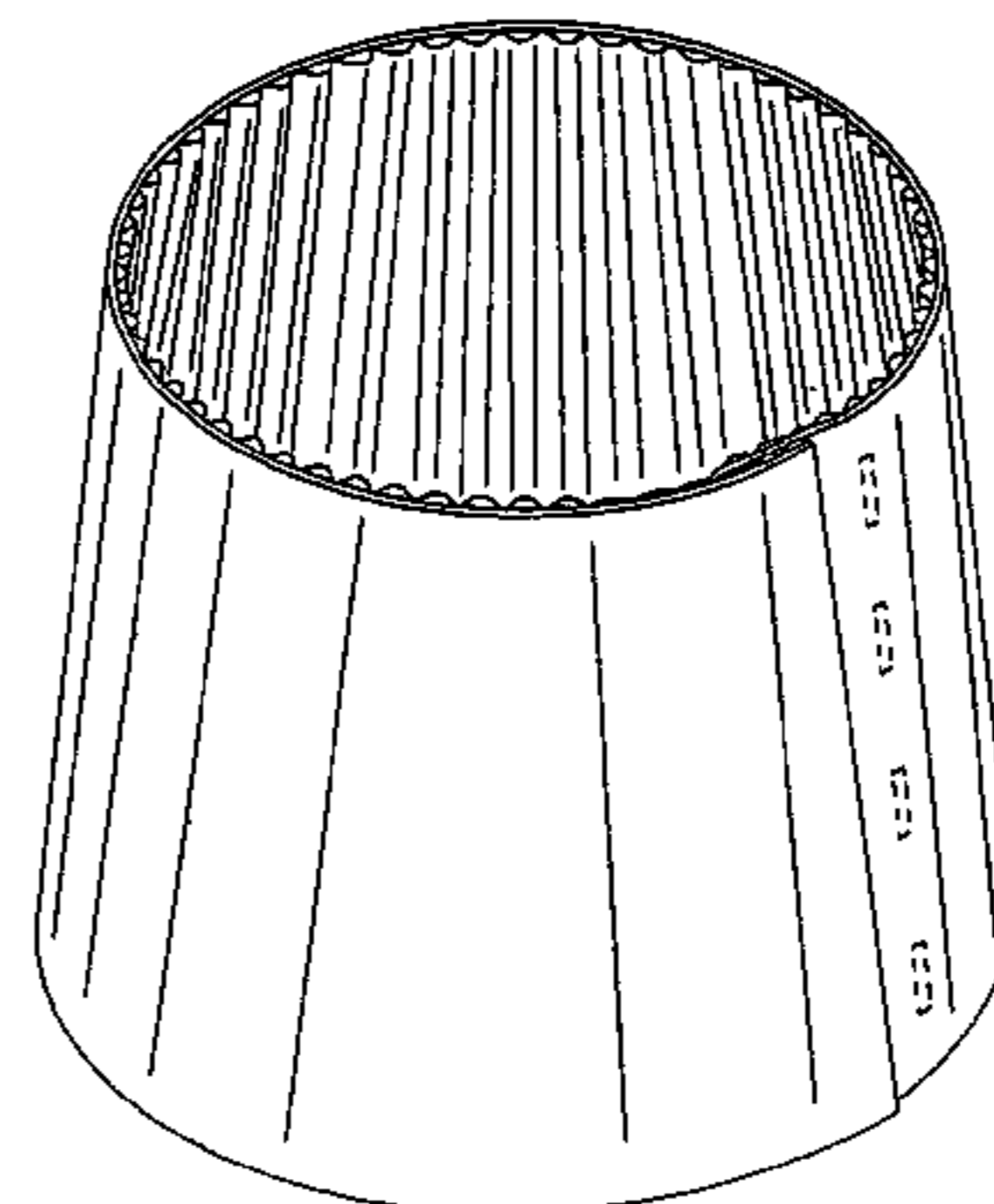
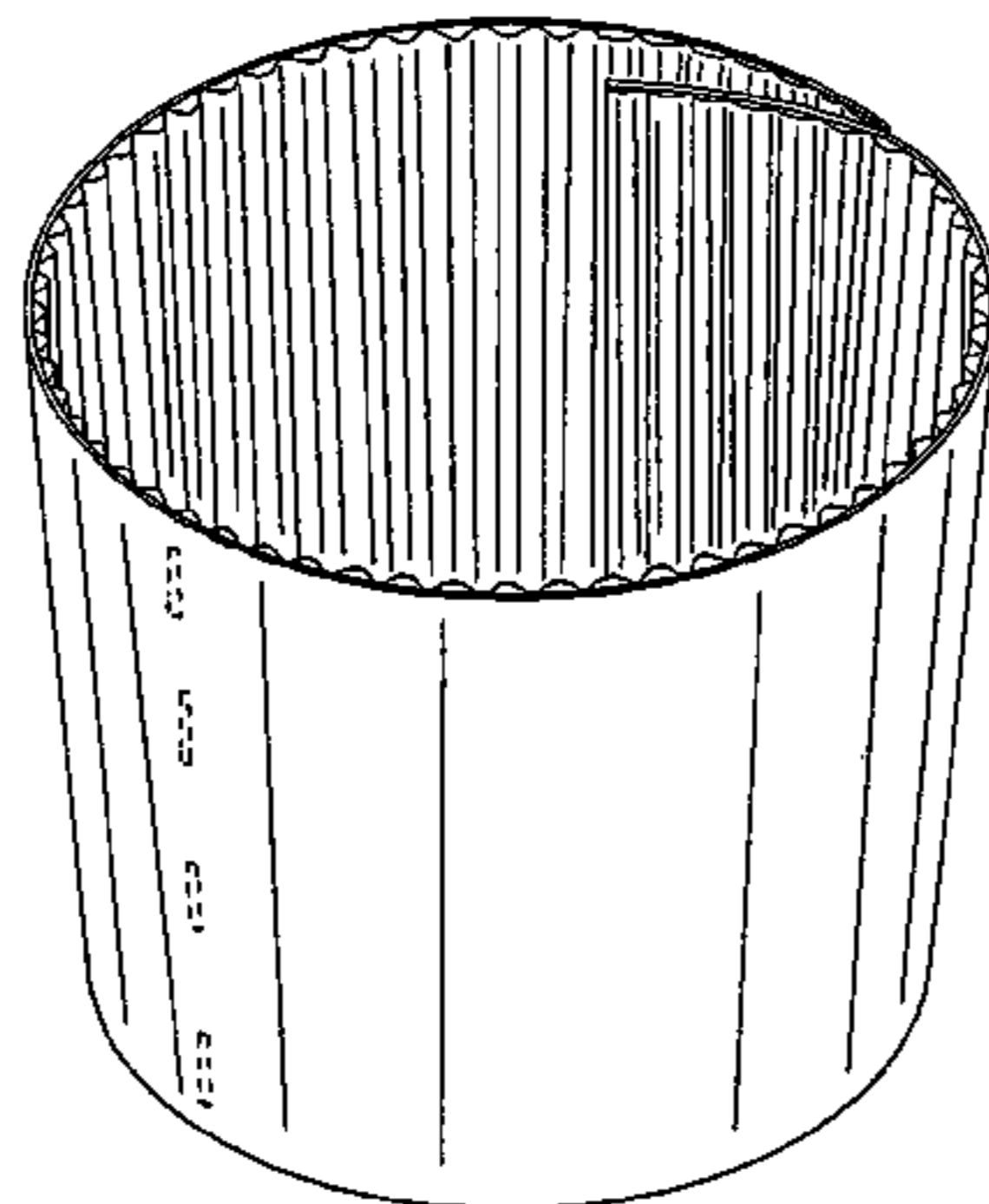

(56)

References Cited

U.S. PATENT DOCUMENTS

5,425,497 A 6/1995 Sorensen
 5,445,315 A 8/1995 Shelby
 5,454,484 A 10/1995 Chelossi
 5,826,786 A 10/1998 Dickert
 5,842,633 A 12/1998 Nurse
 6,196,454 B1 3/2001 Sadlier
 6,334,109 B1 12/2001 Kanevsky et al.
 6,814,253 B2 11/2004 Wong
 6,863,644 B1 3/2005 Cook
 7,000,801 B2 2/2006 Rodriguez
 7,019,859 B2 3/2006 Phillips et al.
 D543,844 S * 6/2007 Cook et al. D9/444
 D547,653 S 7/2007 Wong
 D593,371 S * 6/2009 Karam D7/624.2
 D611,772 S 3/2010 Silverstein et al.
 D614,920 S * 5/2010 Dobbin D7/624.2
 D708,483 S * 7/2014 Gut D7/624.2
 2006/0000882 A1 1/2006 Darzinskas
 2007/0215626 A1 * 9/2007 Wright et al. 220/737
 2008/0041864 A1 2/2008 Wong
 2008/0280742 A1 11/2008 Cerasani
 2009/0014515 A1 1/2009 Silverbrook et al.
 2009/0060606 A1 3/2009 Rawlings et al.
 2009/0099853 A1 4/2009 Lemelson
 2009/0101659 A1 4/2009 Morlan et al.
 2009/0249195 A1 10/2009 Angell
 2009/0287568 A1 11/2009 Cesmedziew
 2010/0018984 A1 1/2010 Solomon

2010/0025414 A1 * 2/2010 Mansour et al. 220/738
 2010/0185726 A1 7/2010 Kedem et al.
 2011/0042451 A1 * 2/2011 Seo 229/403
 2011/0059728 A1 3/2011 Poisson
 2011/0114657 A1 * 5/2011 Nygaard 220/738
 2011/0288942 A1 11/2011 De Wet et al.
 2012/0084154 A1 * 4/2012 Dresner 705/14.66
 2012/0187137 A1 * 7/2012 Lee 220/739
 2012/0263912 A1 * 10/2012 Sanders 428/99
 2013/0043261 A1 * 2/2013 Barton 220/720

FOREIGN PATENT DOCUMENTS

GB 2382049 4/2005
 RU 2264294 11/2005
 WO WO 03/018303 A1 3/2003
 WO WO 2010049826 A1 5/2010

OTHER PUBLICATIONS

U.S. Appl. No. 29/398,619, filed Aug. 2, 2011, Dresner.
 International Search Report and Written Opinion regarding PCT/
 US2011/054447, Feb. 27, 2012.
 Non-Final Office Action regarding U.S. Appl. No. 13/250,959, filed
 Jul. 3, 2013.
 Response to Non-Final Office Action regarding U.S. Appl. No.
 13/250,959, filed Oct. 3, 2013.
 Final Office Action regarding U.S. Appl. No. 13/250,959, filed Dec.
 31, 2013.

* cited by examiner

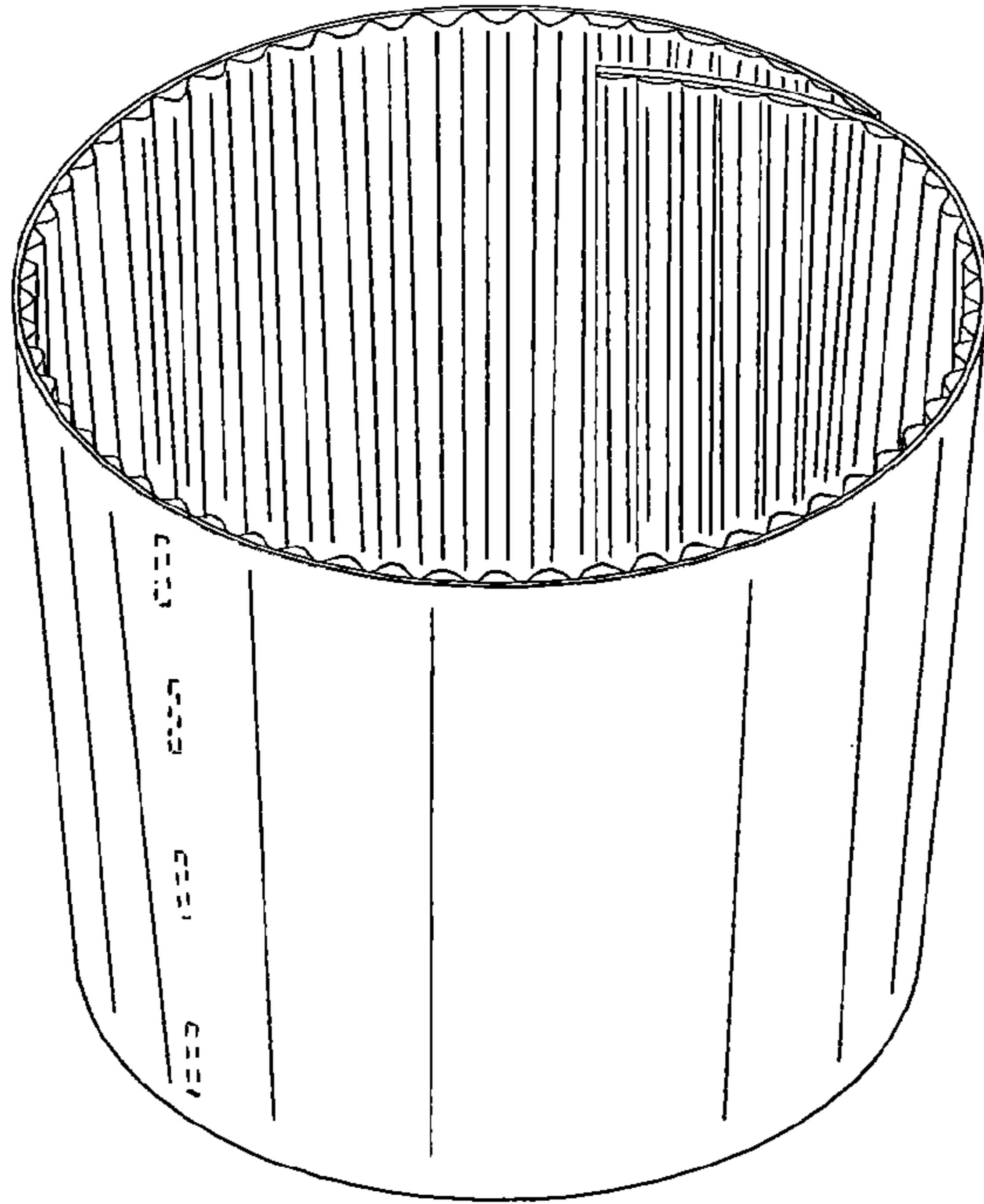

FIG. 1

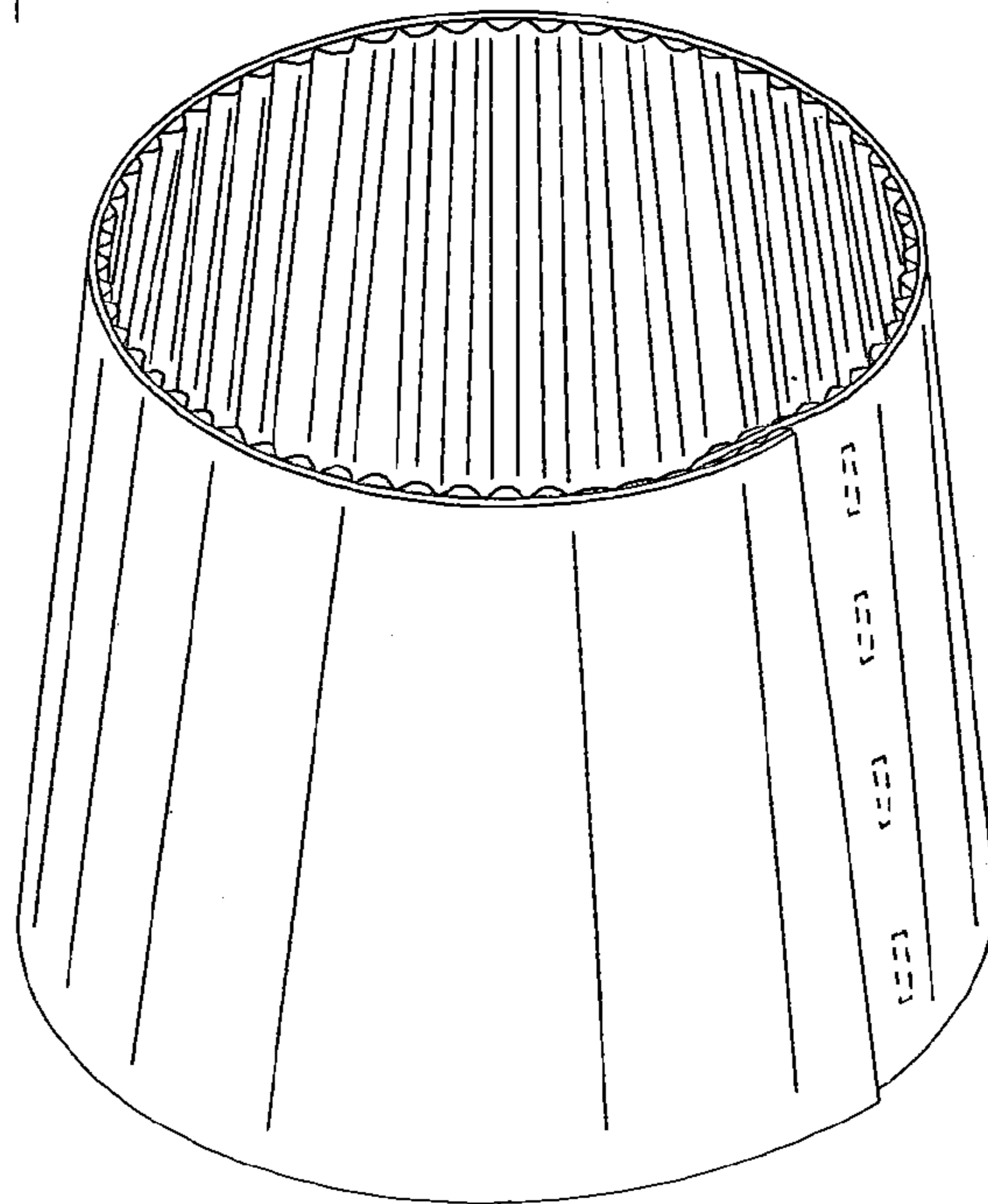

FIG. 2

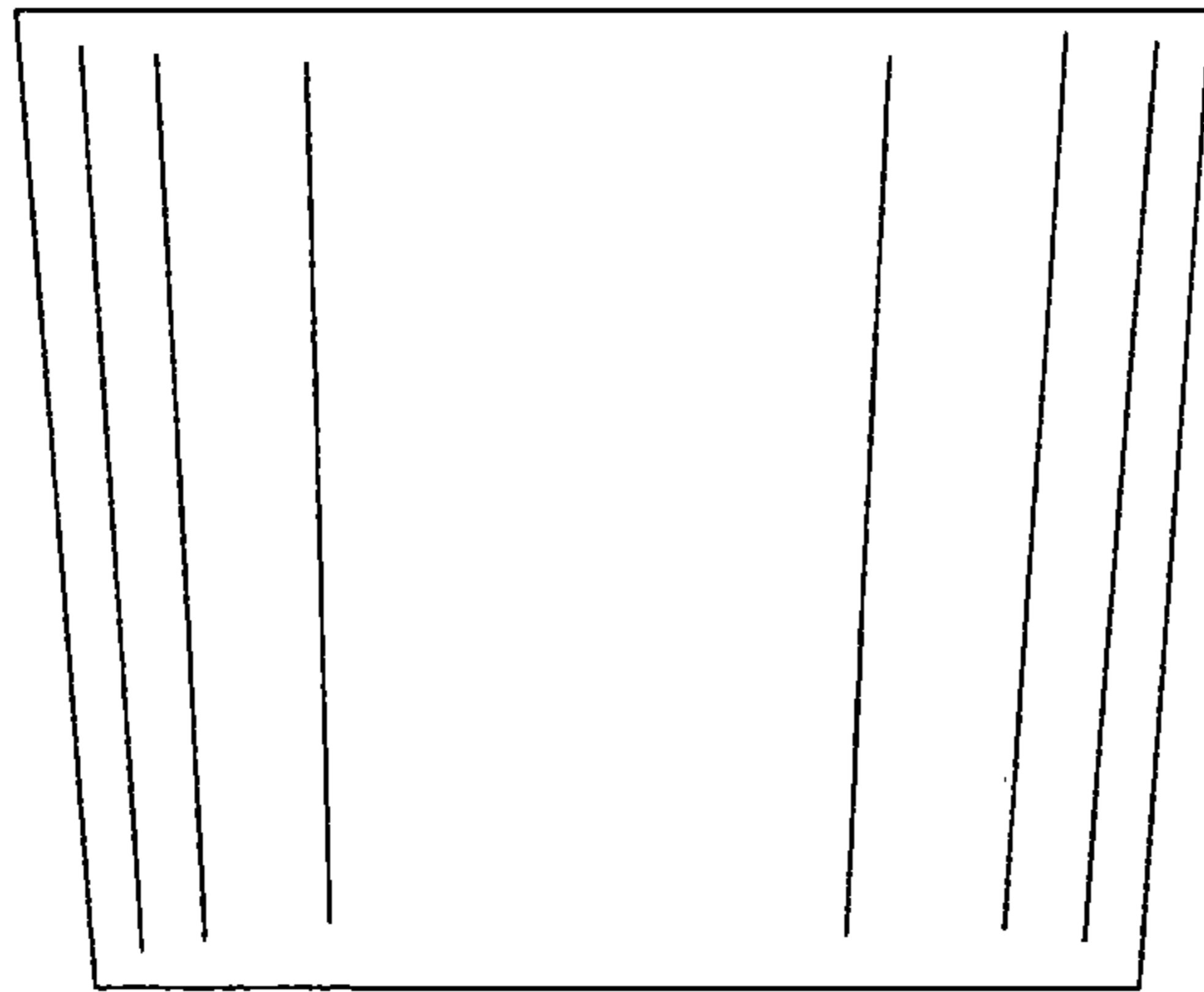

FIG. 3 .

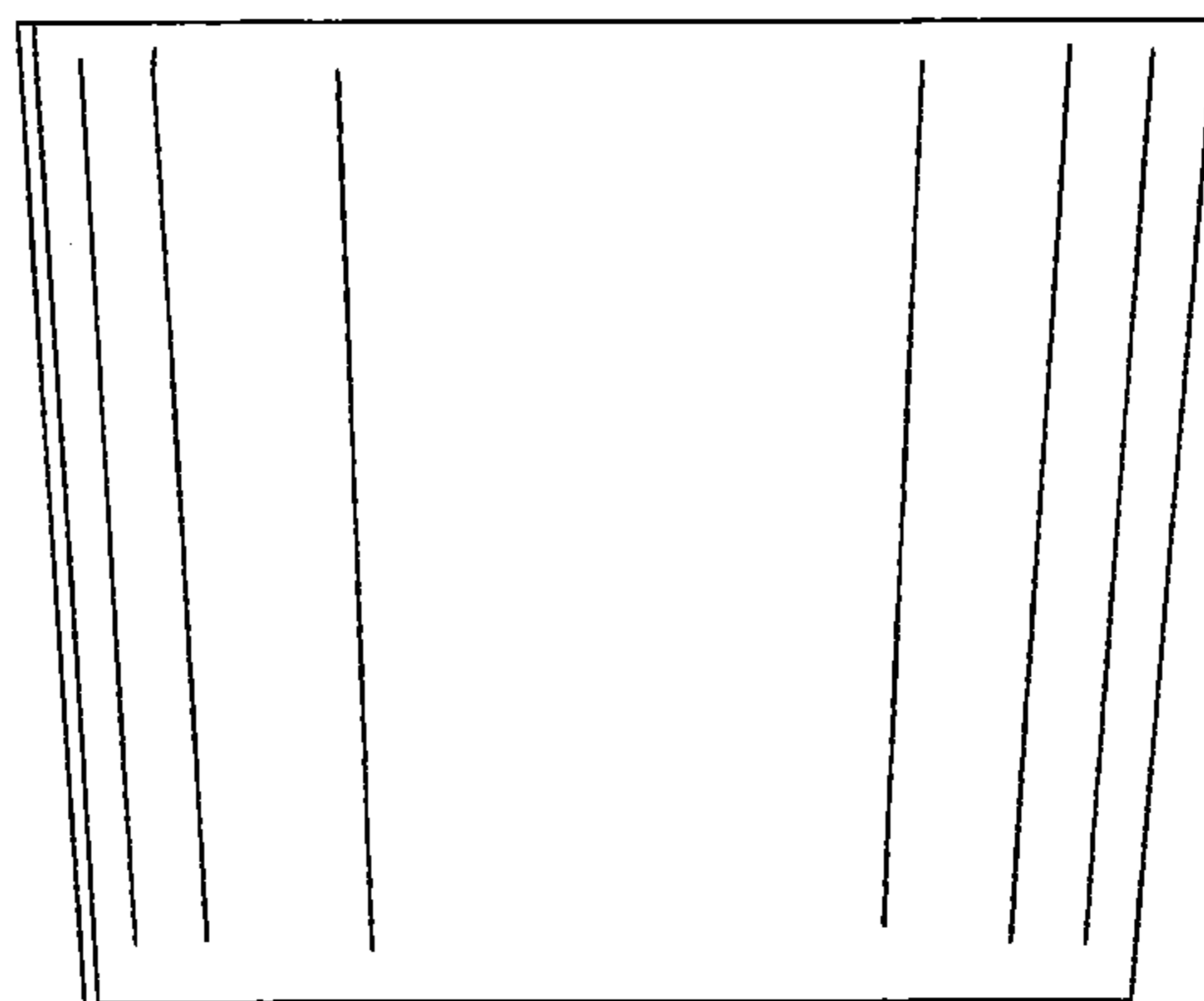

FIG. 4

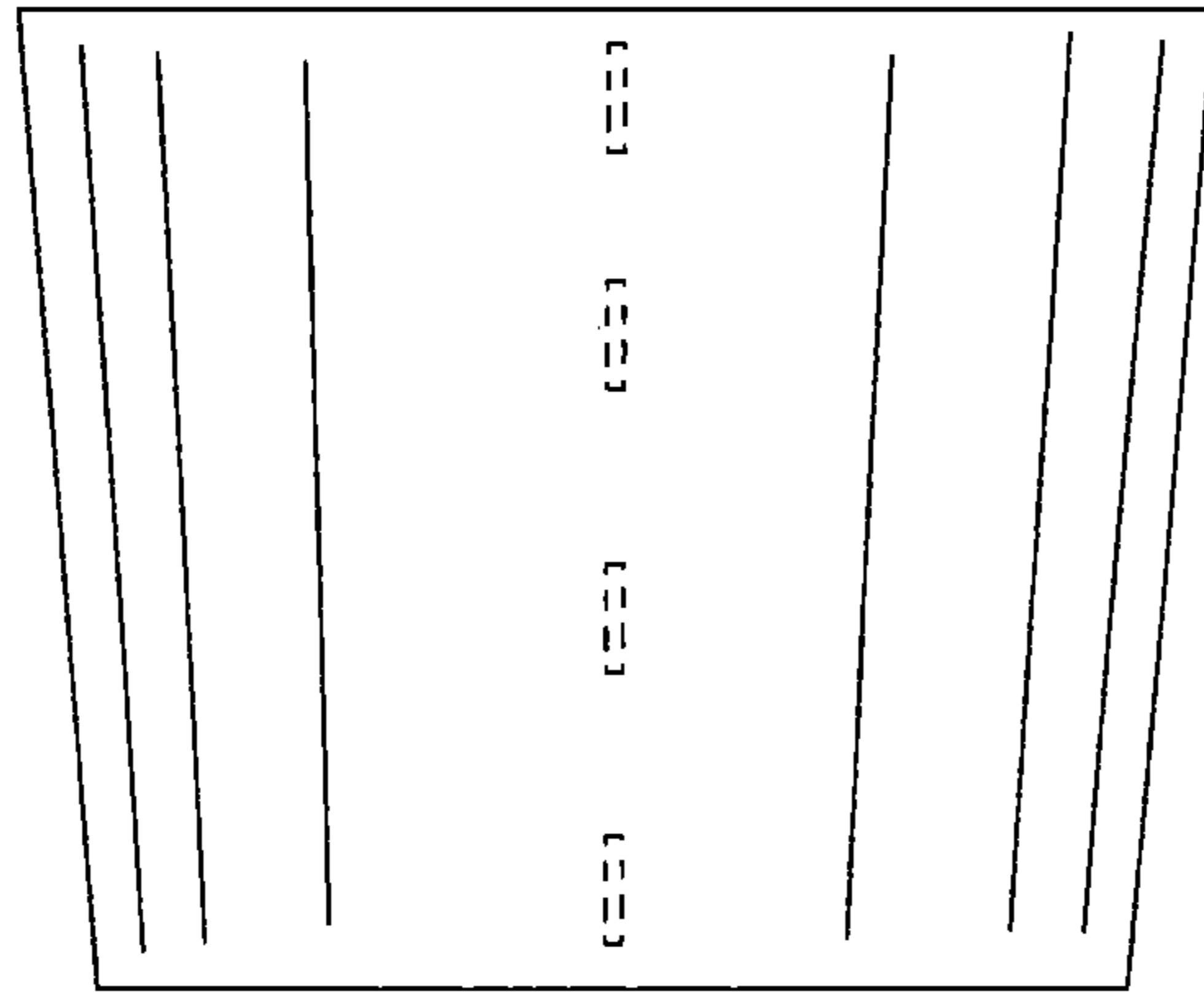

FIG. 5

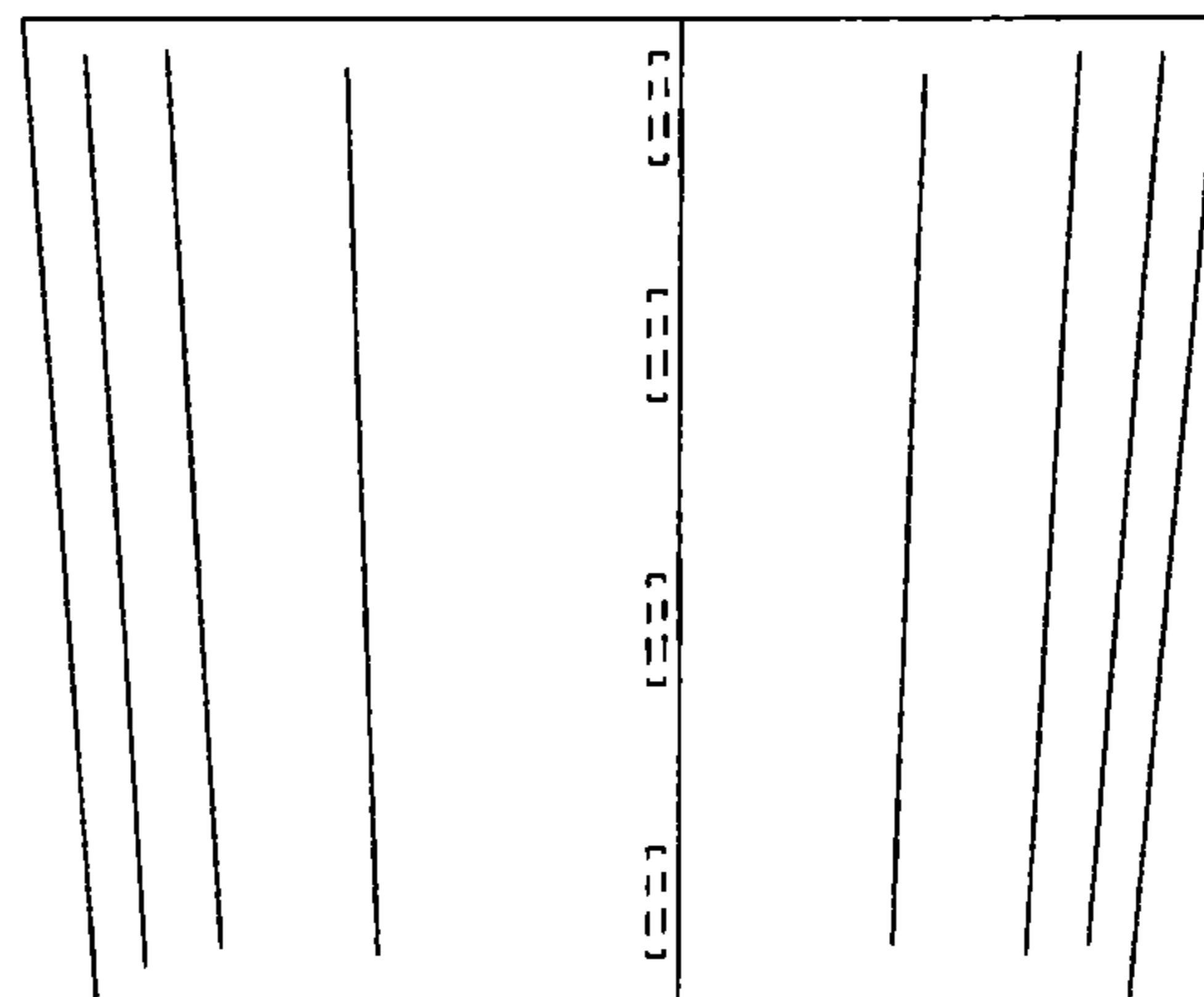

FIG. 6

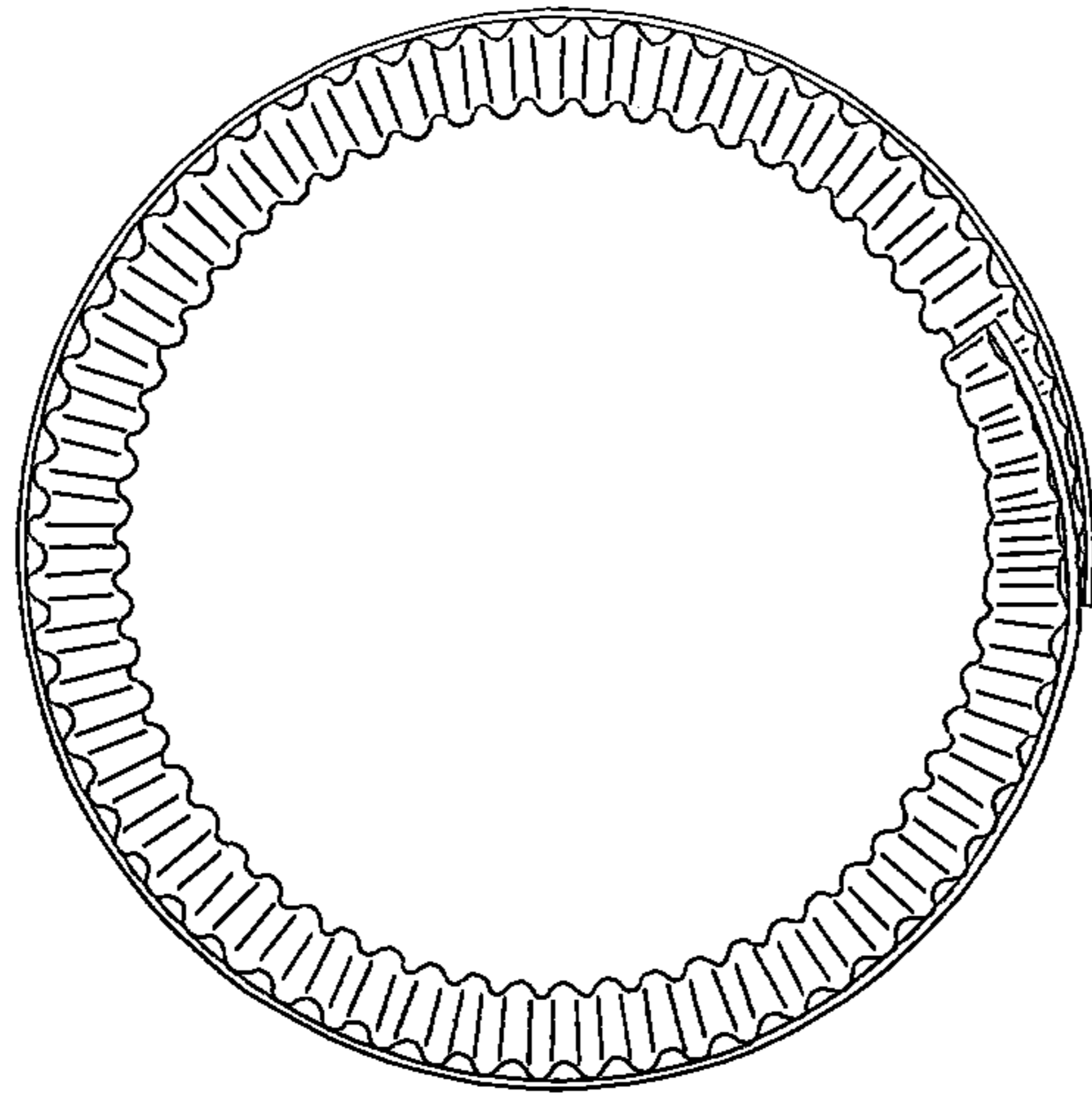

FIG. 7

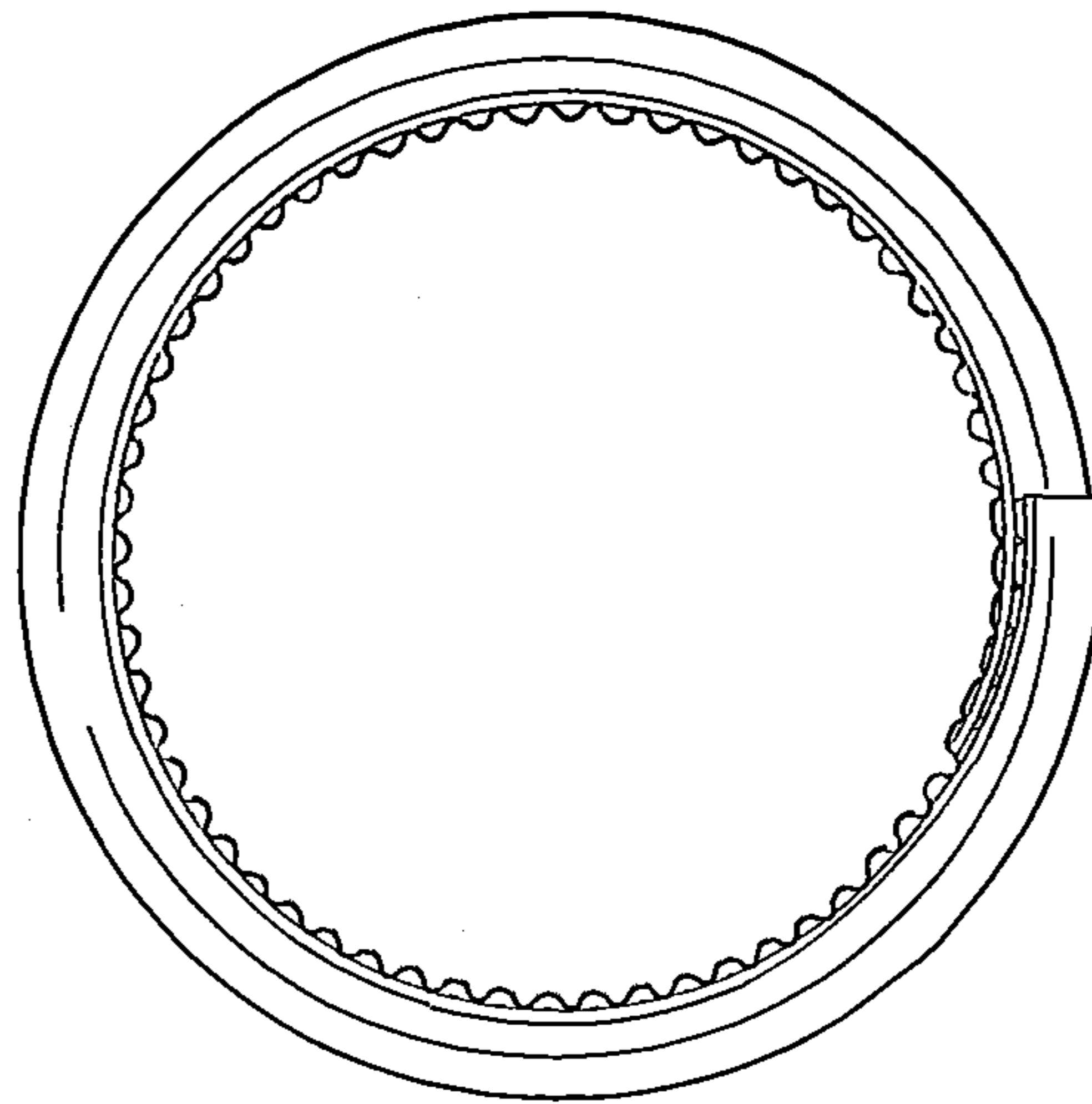

FIG. 8

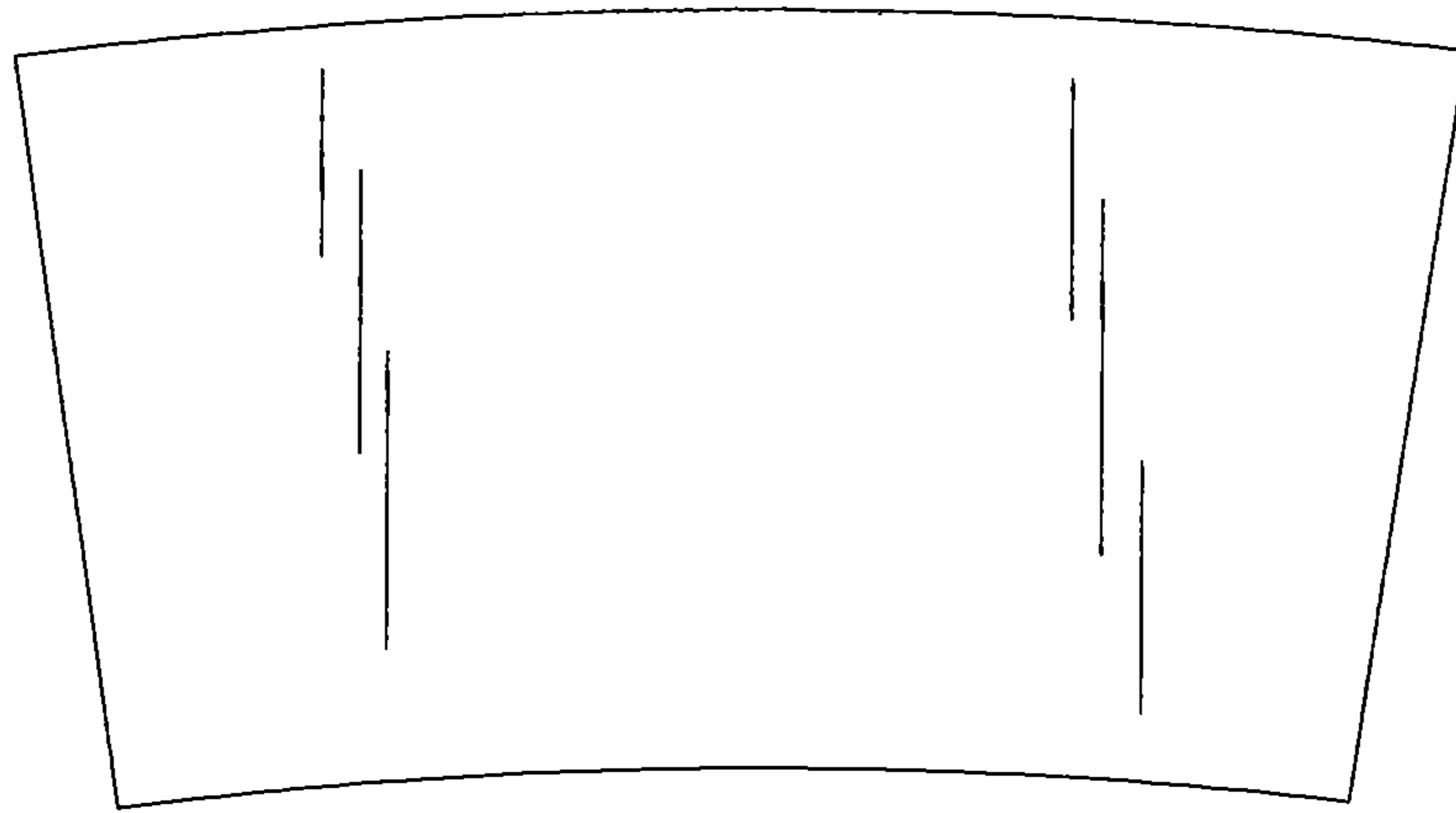

FIG. 9

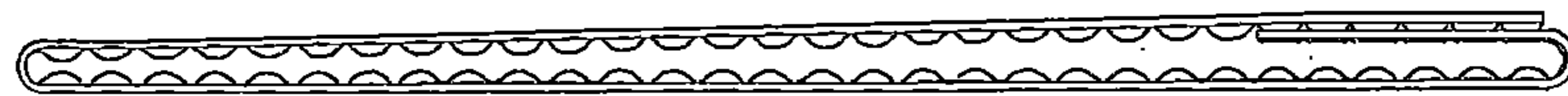

FIG. 10

UNITED STATES PATENT AND TRADEMARK OFFICE
CERTIFICATE OF CORRECTION

PATENT NO. : D720,576 S
APPLICATION NO. : 29/405357
DATED : January 6, 2015
INVENTOR(S) : David Andrew Dresner

Page 1 of 2

It is certified that error appears in the above-identified patent and that said Letters Patent is hereby corrected as shown below:

On the Title page, delete the set of Figures and substitute therefor the set of Figures as shown on the attached Title page.

Signed and Sealed this
Twenty-first Day of April, 2015



Michelle K. Lee
Director of the United States Patent and Trademark Office

(12) **United States Design Patent**
Dresner

(10) **Patent No.:** **US D720,576 S**
(45) **Date of Patent:** ** *Jan. 6, 2015

(54) **SLEEVE FOR A BEVERAGE CUP**

(75) **Inventor:** **David Andrew Dresner**, Glencoe, IL (US)

(73) **Assignee:** **Kymo Enterprises, LLC**, St. Louis, MO (US)

(*) **Notice:** This patent is subject to a terminal disclaimer.

(**) **Term:** **14 Years**

(21) **Appl. No.:** **29/405,357**

(22) **Filed:** **Nov. 1, 2011**

(51) **LOC (10) Cl.** **07-06**

(52) **U.S. Cl.**
USPC **D7/624.2**

(58) **Field of Classification Search**
CPC **B65D 81/3886**
USPC **D7/624.2, 624.1, 601, 602, 619.1-625, D7/605, 606, 607, 608, 624.3; D9/438, D9/444, 434; 220/737-739, 902, 903, 673; 62/457.1-457.9; 229/400, 402, 403, 229/800, 906.1, 939; 215/12.1, 12.2, 13.1, 215/10; 206/503**

See application file for complete search history.

(56) **References Cited**

U.S. PATENT DOCUMENTS

449,119 A * 3/1891 Hall 215/12.1
3,138,371 A * 6/1964 Feher et al. 366/341
5,205,473 A 4/1993 Coffin, Sr.

(Continued)

FOREIGN PATENT DOCUMENTS

CA 118198 11/2007
CA 122422 11/2007

(Continued)

OTHER PUBLICATIONS

U.S. Appl. No. 13/250,959, filed Sep. 30, 2011, Dresner.

(Continued)

Primary Examiner -- Ian Simmons

Assistant Examiner -- Shannon Morgan

(74) *Attorney, Agent, or Firm* -- Polsinelli PC

(57) **CLAIM**

The ornamental design for a sleeve for a beverage cup, as shown and described.

DESCRIPTION

FIG. 1 is a top isometric view of the sleeve for a beverage cup; FIG. 2 is a bottom isometric view of the sleeve for a beverage cup; FIG. 3 is a front view of the sleeve for a beverage cup; FIG. 4 is a rear view of the sleeve for a beverage cup; FIG. 5 is a left side view of the sleeve for a beverage cup; FIG. 6 is a right side view of the sleeve for a beverage cup; FIG. 7 is a top view of the sleeve for a beverage cup; FIG. 8 is a bottom view of the sleeve for a beverage cup; FIG. 9 is a front view of the sleeve for a beverage cup in a collapsed position; and, FIG. 10 is a top view of the sleeve for a beverage cup in a collapsed position.

The broken lines in FIGS. 1, 2, 5, and 6 of the sleeve for a beverage cup is for the purpose of illustrating environment, and forms no part of the claimed design.

1 Claim, 5 Drawing Sheets

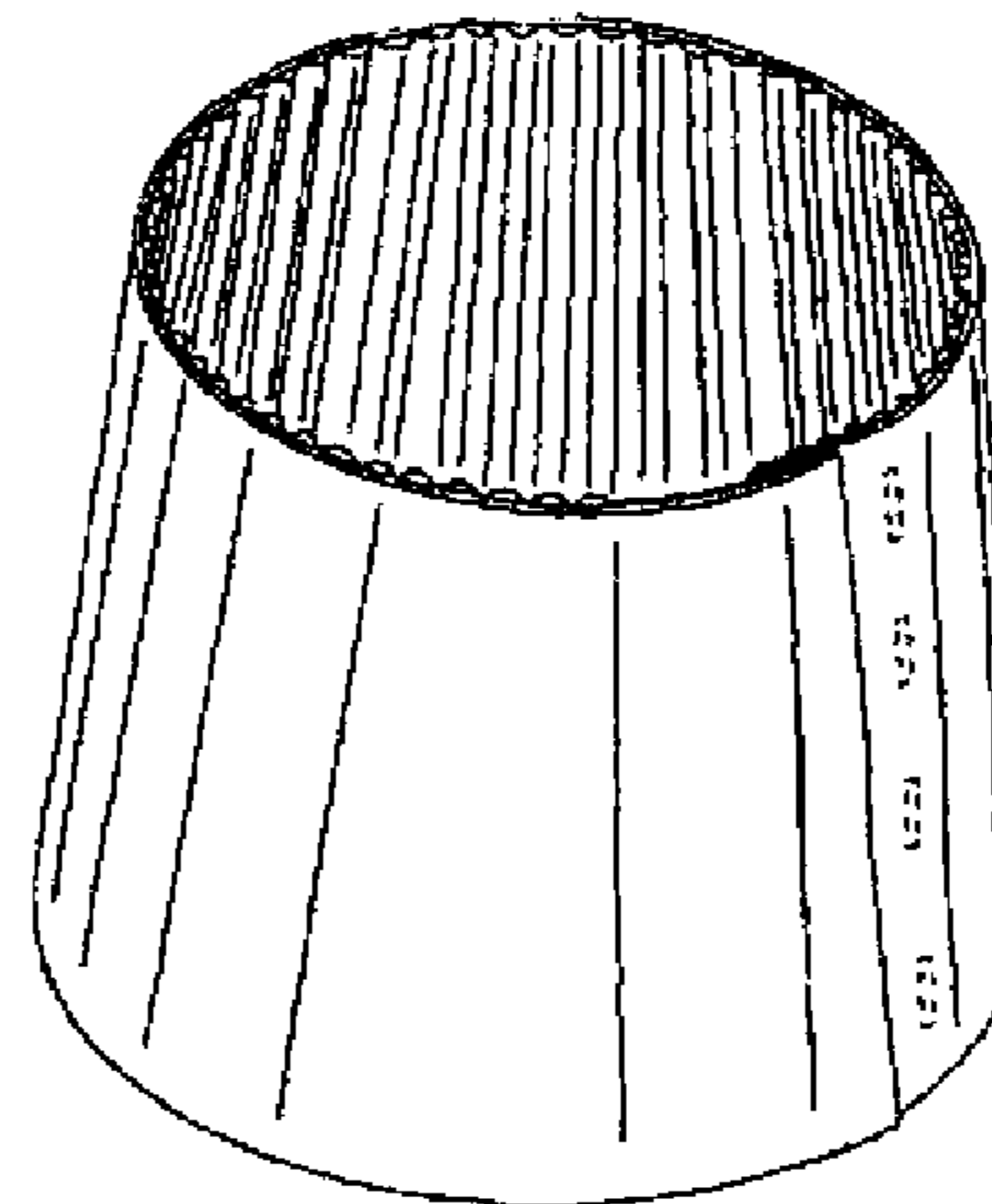
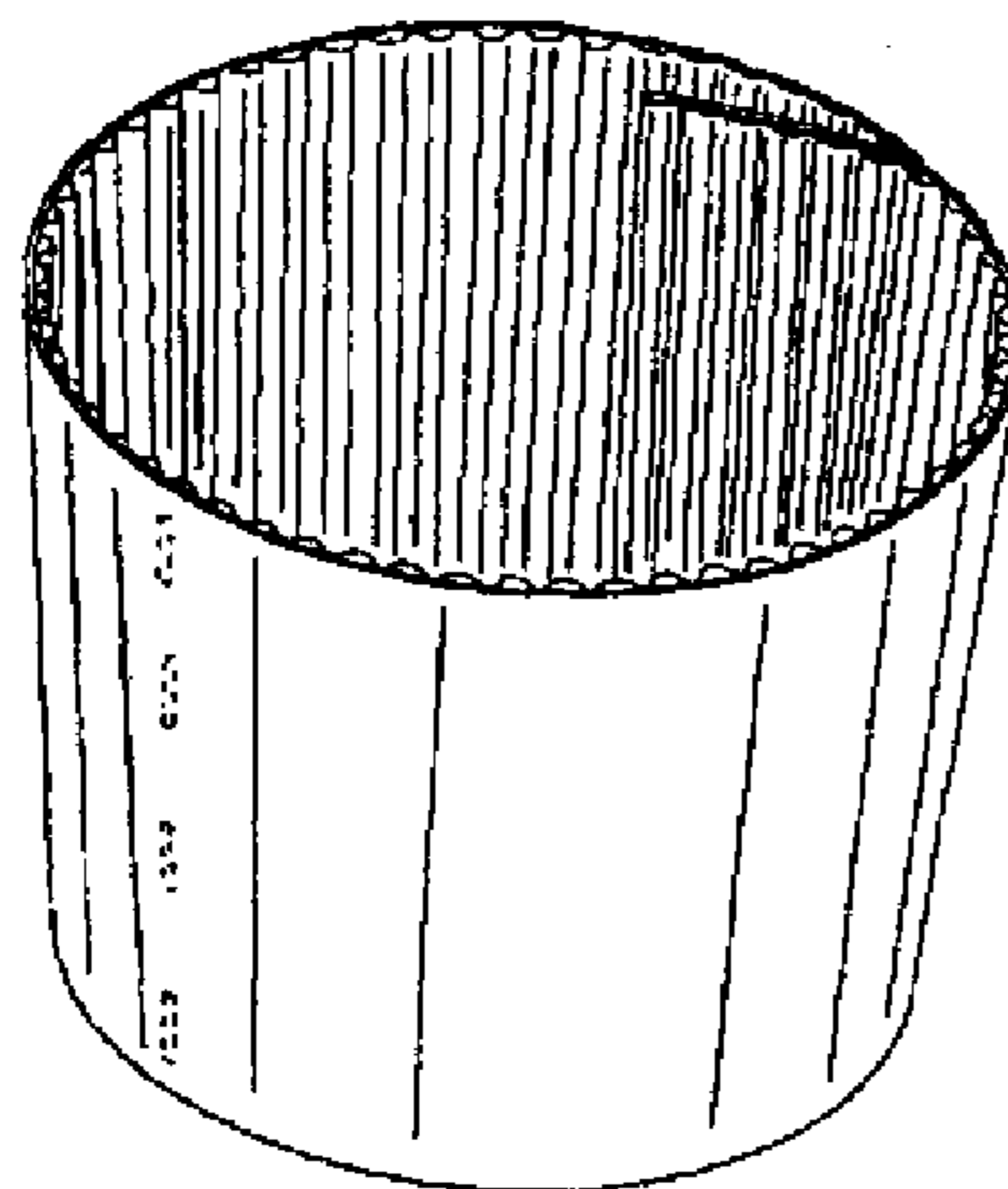

UNITED STATES PATENT AND TRADEMARK OFFICE
CERTIFICATE OF CORRECTION

PATENT NO. : D720,576 S
APPLICATION NO. : 29/405357
DATED : January 6, 2015
INVENTOR(S) : David Andrew Dresner

Page 1 of 7

It is certified that error appears in the above-identified patent and that said Letters Patent is hereby corrected as shown below:

The Title page, showing the illustrative figure, should be deleted and substitute therefor the attached Title page.

Drawings

Delete drawings sheets 1-10 and substitute therefor the drawing sheets, consisting of figs. 1-10 as shown on the attached pages.

Signed and Sealed this
Twenty-seventh Day of October, 2015



Michelle K. Lee
Director of the United States Patent and Trademark Office

(12) **United States Design Patent**
Dresner

(30) **Patent No.:** **US D720,576 S**

(45) **Date of Patent:** ** ***Jan. 6, 2015**

(54) **SLEEVE FOR A BEVERAGE CUP**

(75) **Investor:** **David Andrew Dresner**, Glencoe, IL
 (US)

(73) **Assignee:** **Kymo Enterprises, LLC**, St. Louis, MO
 (US)

(*) **Notice:** This patent is subject to a terminal disclaimer.

(**) **Term:** **14 Years**

(21) **Appl. No.:** **29/405,357**

(22) **Filed:** **Nov. 1, 2011**

(51) **LOC (10) CL** **07-06**

(52) **U.S. CL**
 USPC **D7/624.2**

(58) **Field of Classification Search**
 CPC B65D 81/3886
 USPC D7/624.2, 624.1, 601, 602, 619.1-625,
 D7/605, 606, 607, 608, 624.3; D9/438,
 D9/444, 434; 220/737-739, 902, 905, 673;
 62/457.1-457.9; 229/400, 402, 403,
 229/800, 906.1, 939; 215/12.1, 12.2, 13.1,
 215/10; 206/503

See application file for complete search history.

(56) **References Cited**

U.S. PATENT DOCUMENTS

449,119 A * 3/1891 Hall 215/12.1
 3,138,371 A * 6/1964 Feher et al. 366/341
 5,205,473 A 4/1993 Coffin, Sr.

(Continued)

FOREIGN PATENT DOCUMENTS

CA 118198 11/2007
 CA 122422 11/2007

(Continued)

OTHER PUBLICATIONS

U.S. Appl. No. 13/258,959, filed Sep. 30, 2011, Dresner

(Continued)

Primary Examiner --- Ian Simons

Assistant Examiner --- Shannon Morgan

(74) *Attorney, Agent, or Firm* --- Polsinelli PC

(57) **CLAIM**

The ornamental design for a sleeve for a beverage cup, as shown and described.

DESCRIPTION

FIG. 1 is a top isometric view of the sleeve for a beverage cup;
 FIG. 2 is a bottom isometric view of the sleeve for a beverage cup;

FIG. 3 is a front view of the sleeve for a beverage cup;
 FIG. 4 is a rear view of the sleeve for a beverage cup;
 FIG. 5 is a left side view of the sleeve for a beverage cup;
 FIG. 6 is a right side view of the sleeve for a beverage cup;
 FIG. 7 is a top view of the sleeve for a beverage cup;
 FIG. 8 is a bottom view of the sleeve for a beverage cup;
 FIG. 9 is a front view of the sleeve for a beverage cup in a collapsed position; and,
 FIG. 10 is a top view of the sleeve for a beverage cup in a collapsed position.

The broken lines in FIGS. 1, 2, 5, and 6 of the sleeve for a beverage cup is for the purpose of illustrating environment, and forms no part of the claimed design.

1 Claim, 5 Drawing Sheets

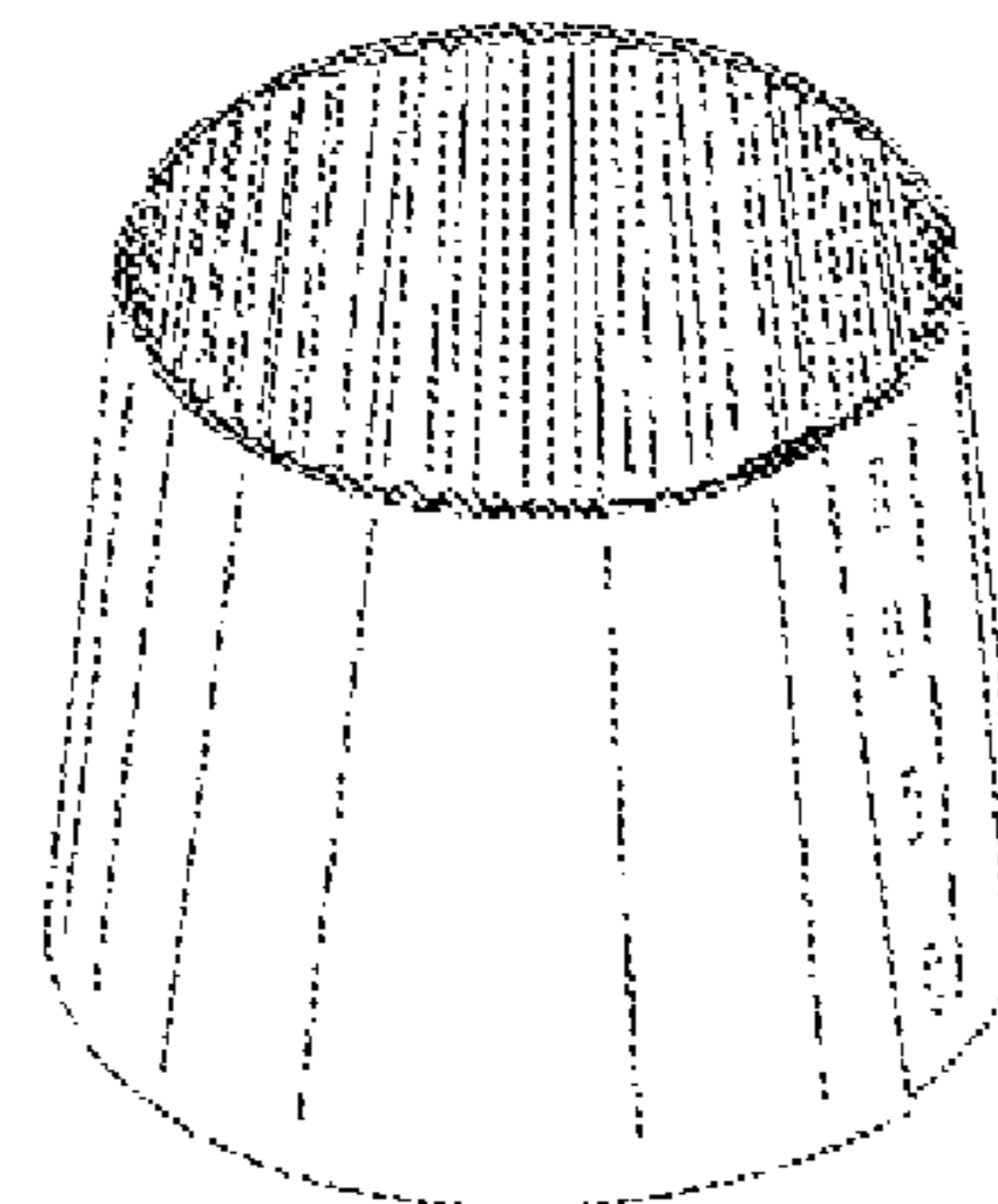
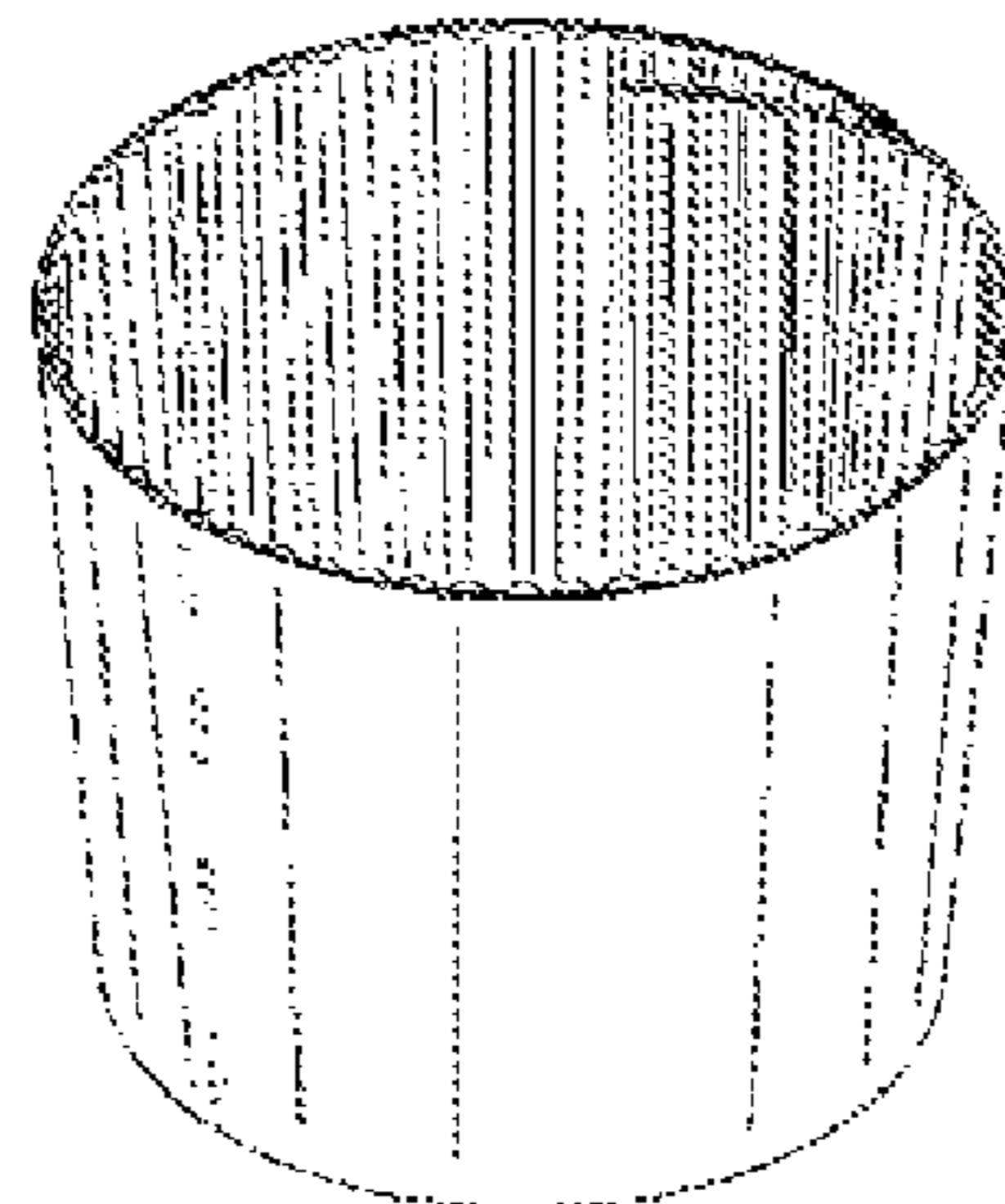

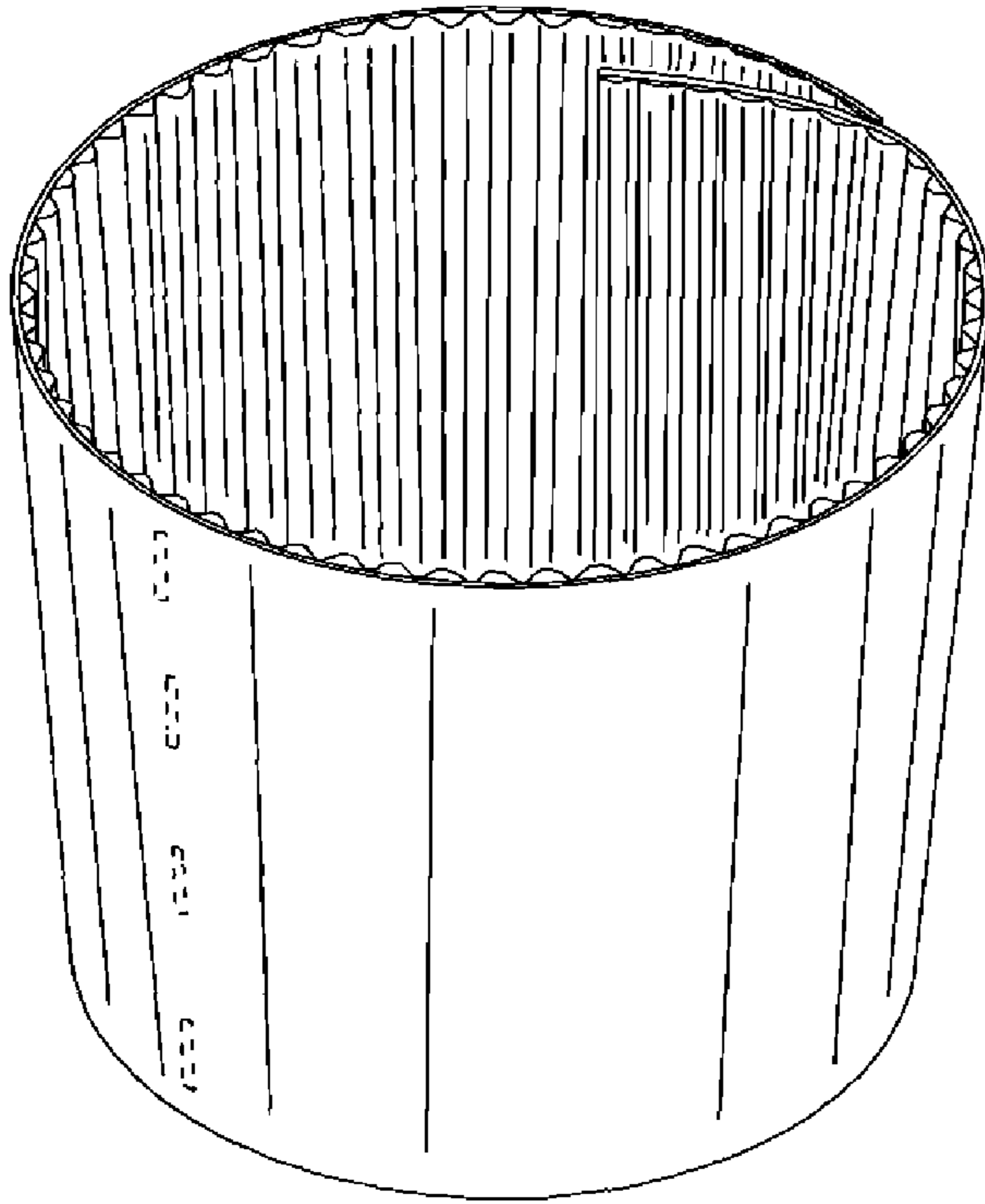

FIG. 1

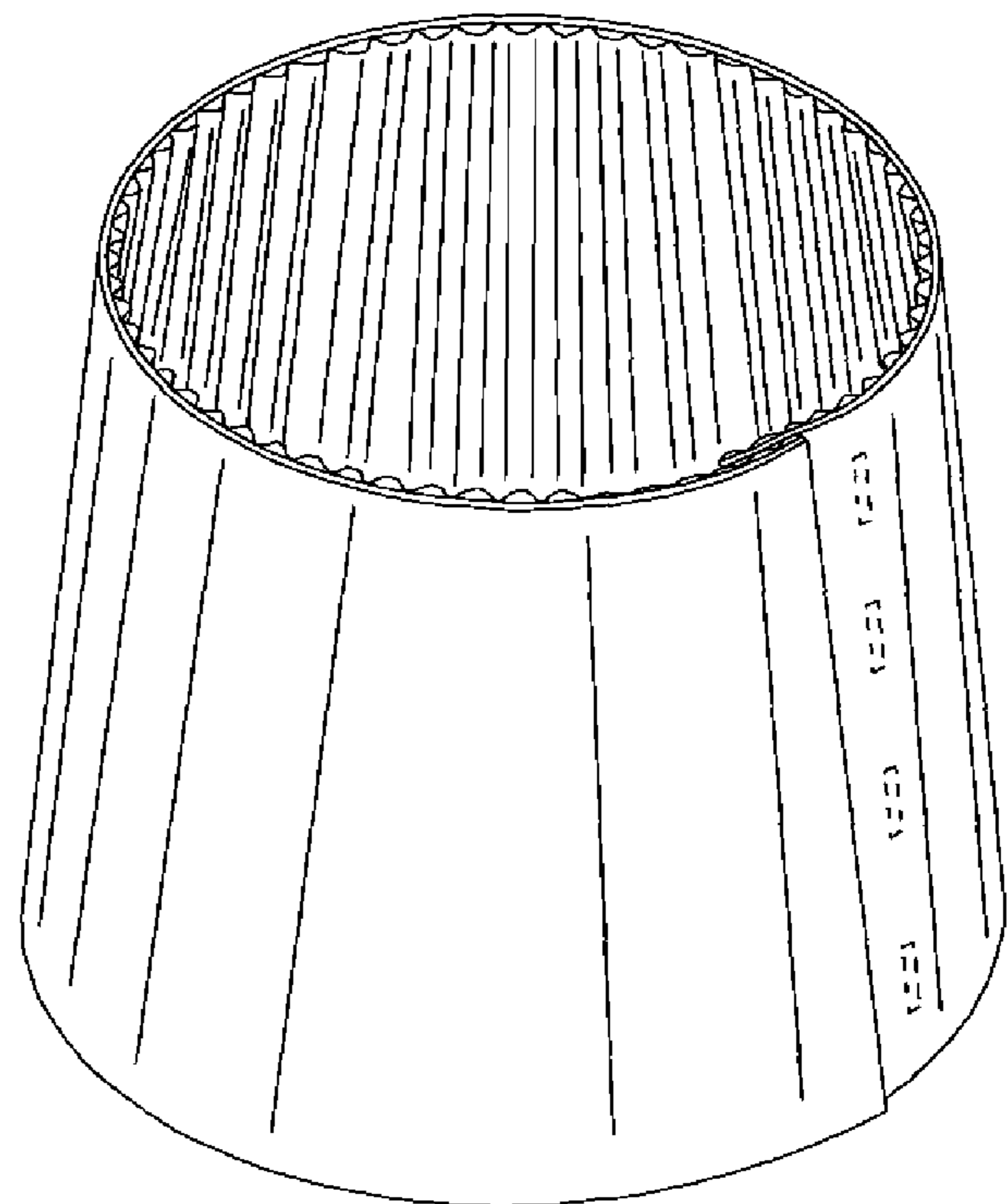

FIG. 2

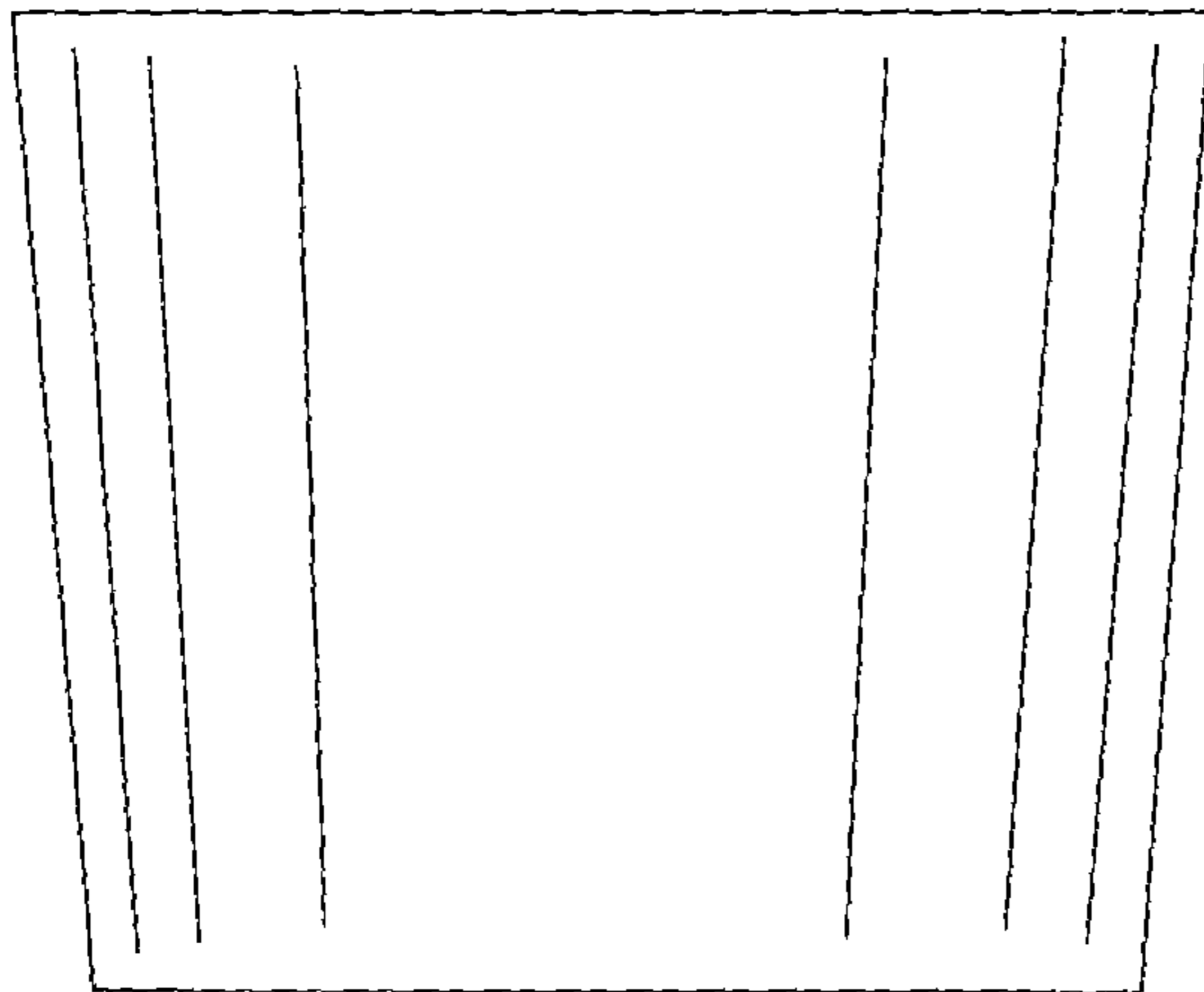

FIG. 3

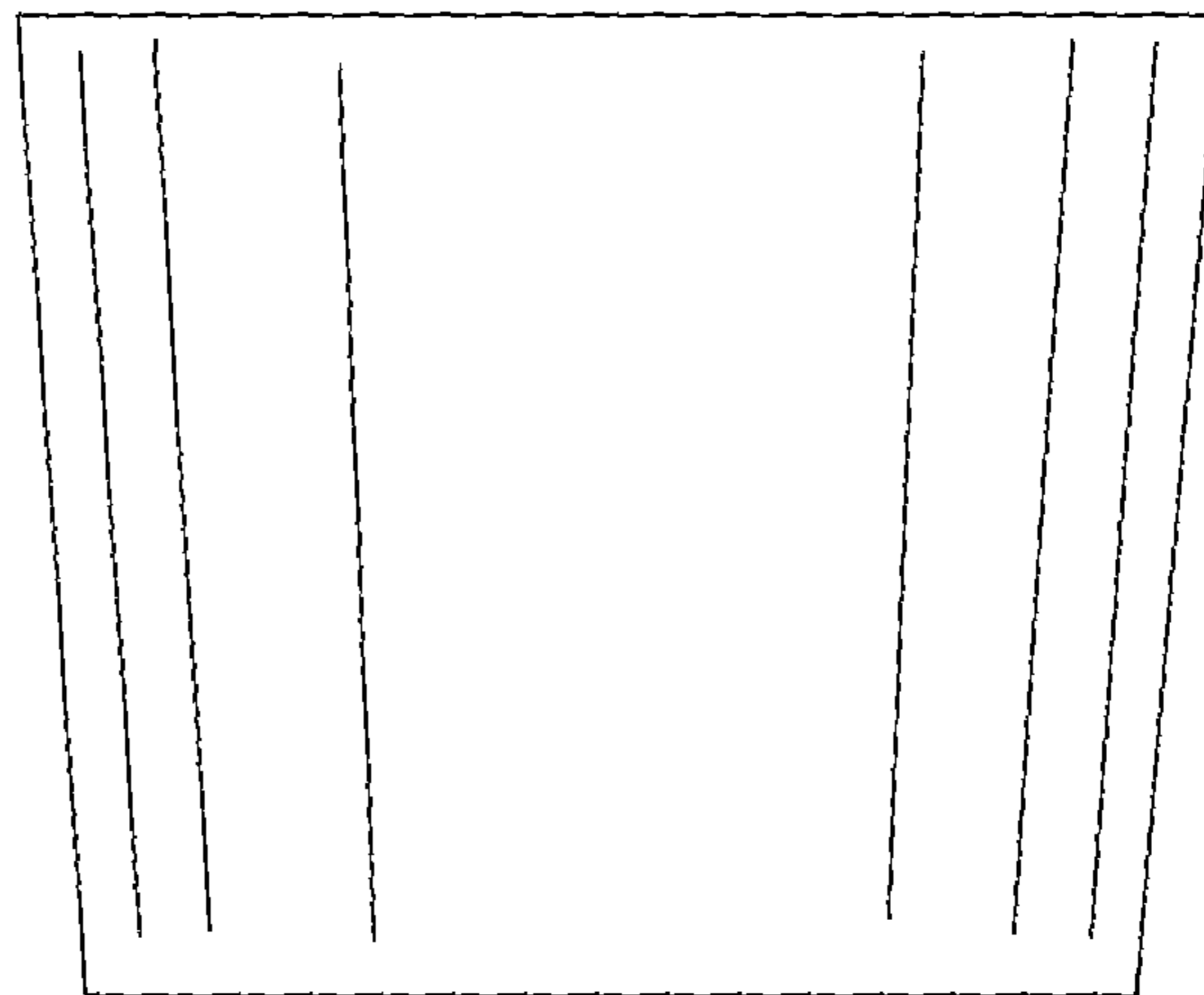
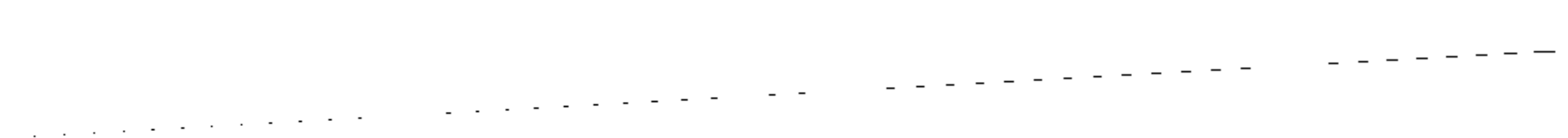

FIG. 4



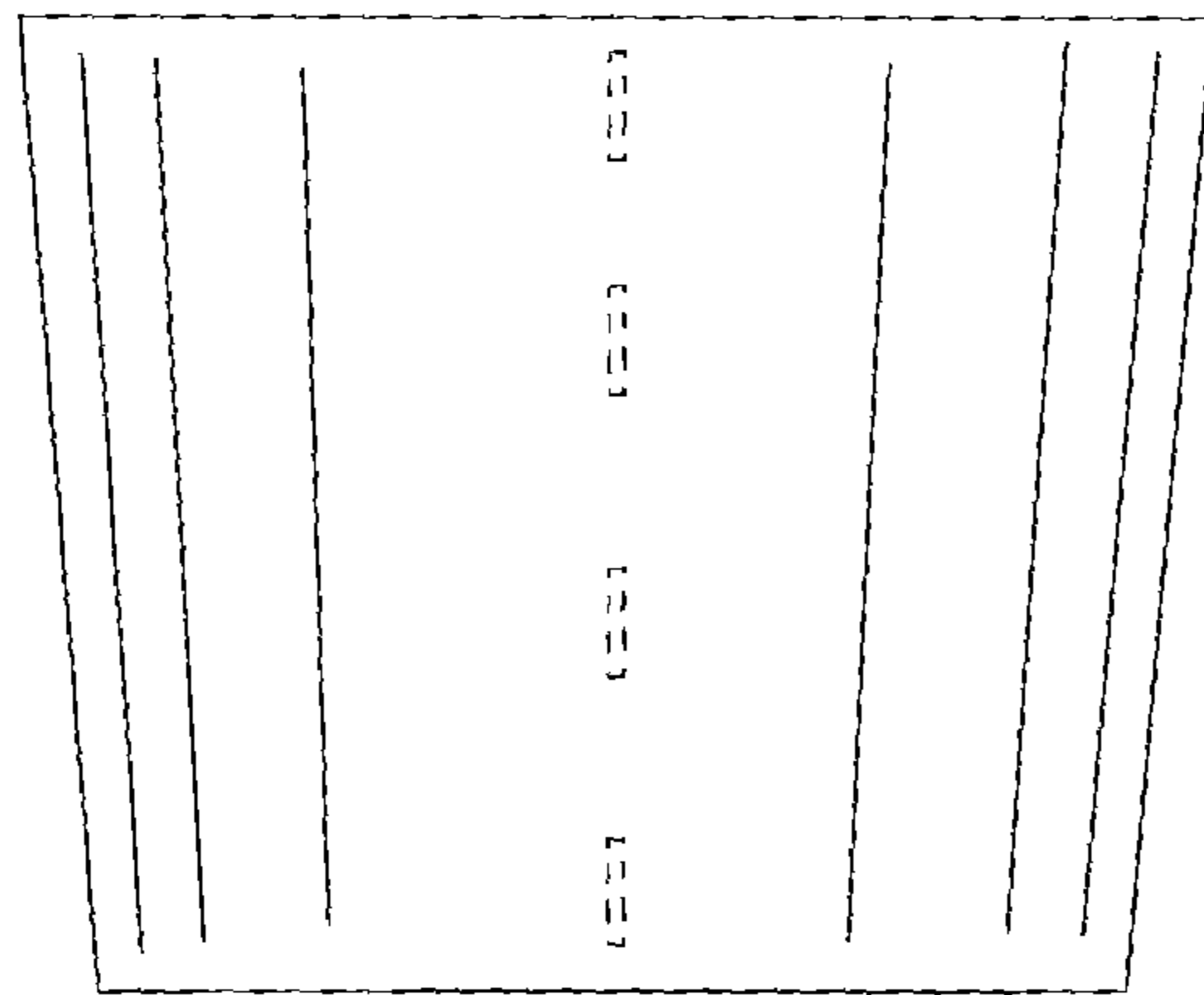

FIG. 5

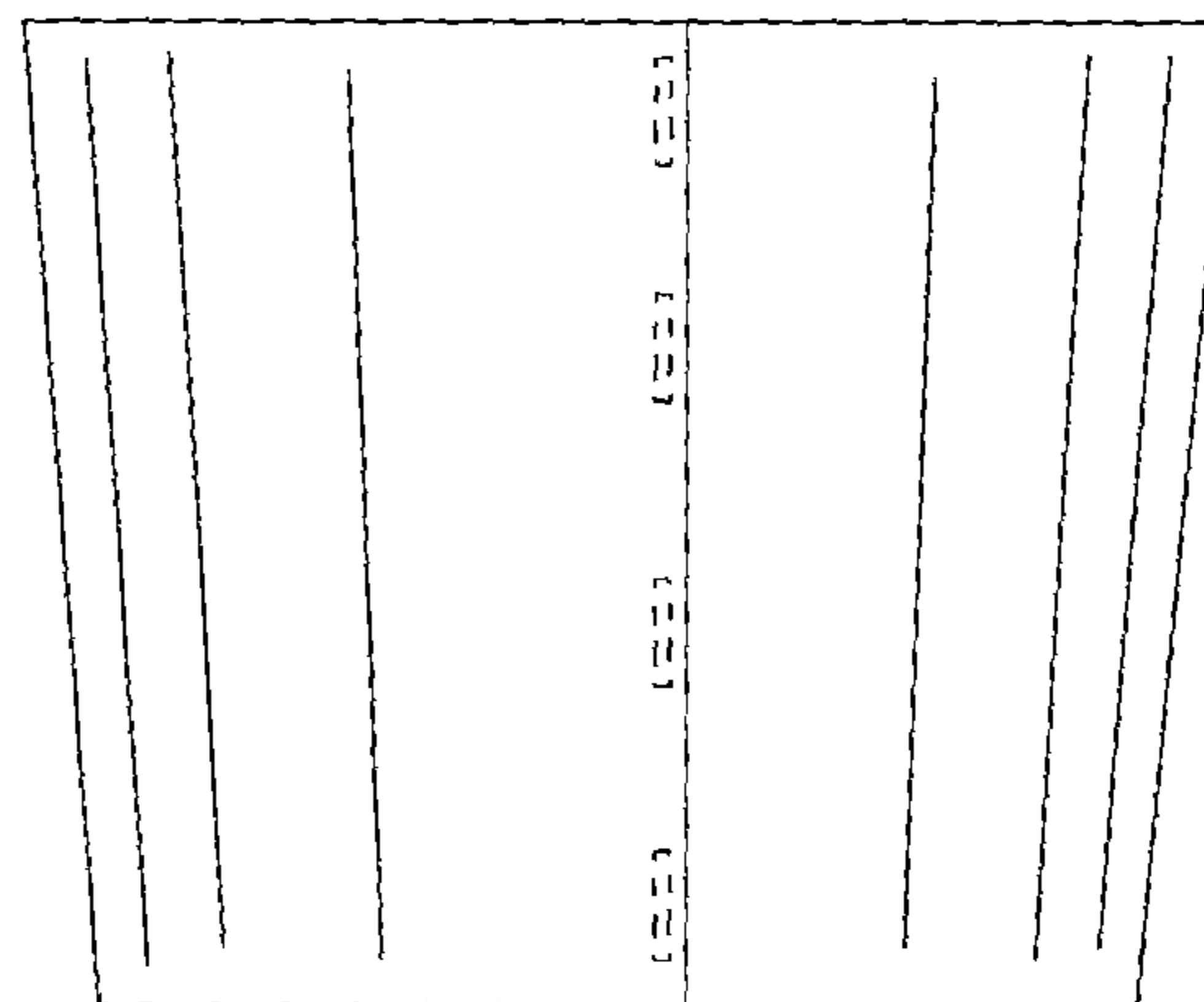

FIG. 6

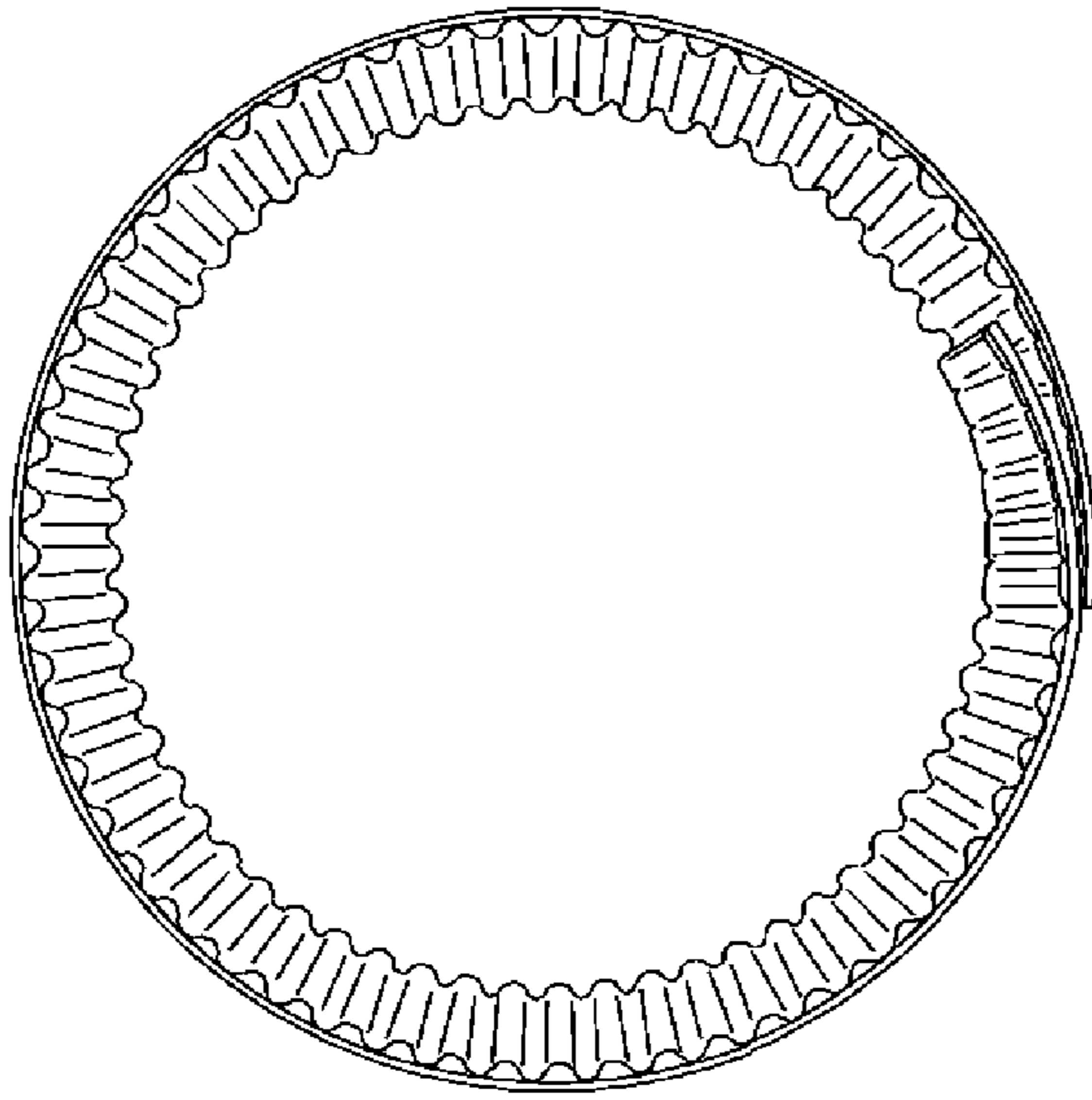

FIG. 7

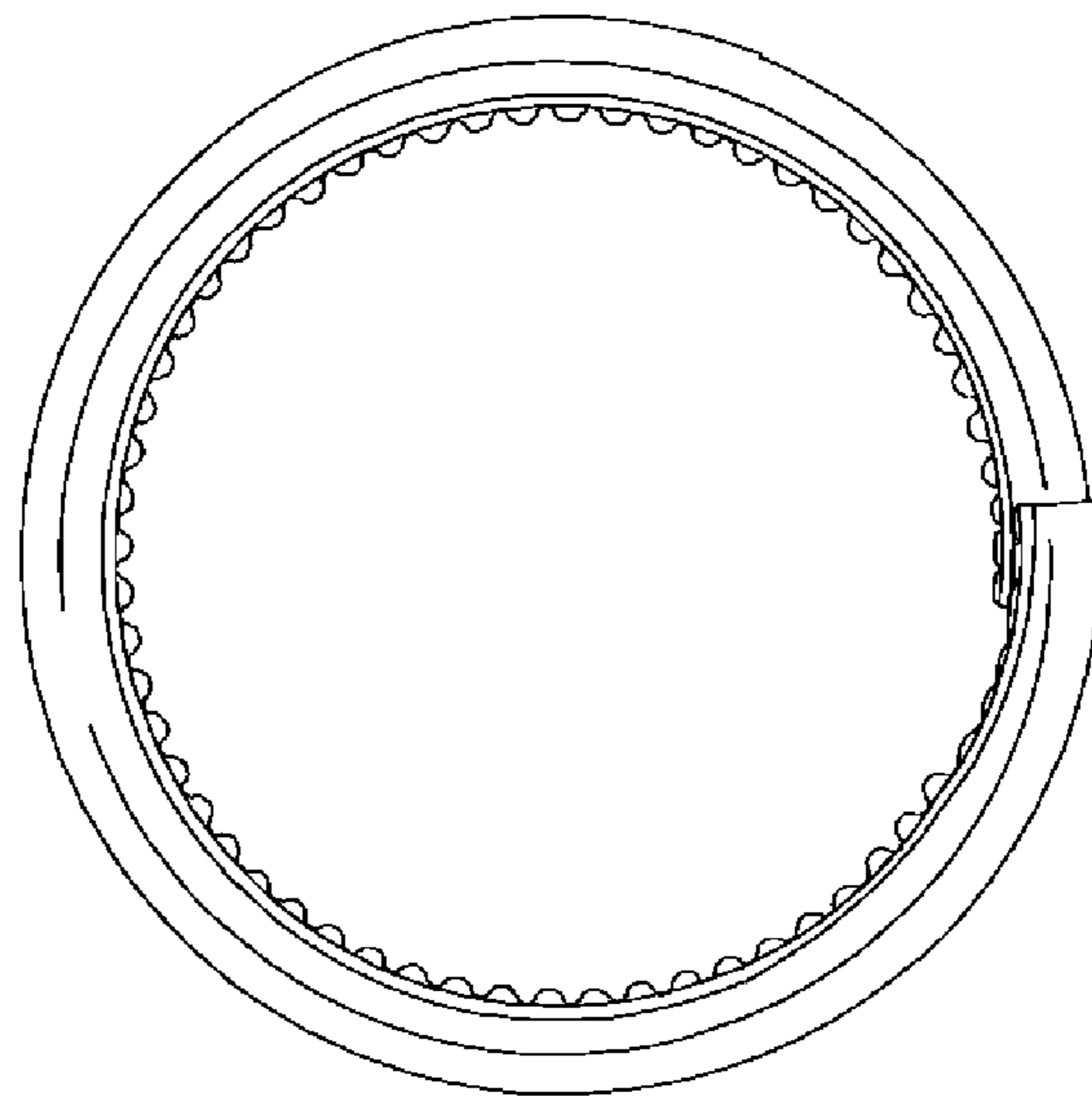

FIG. 8

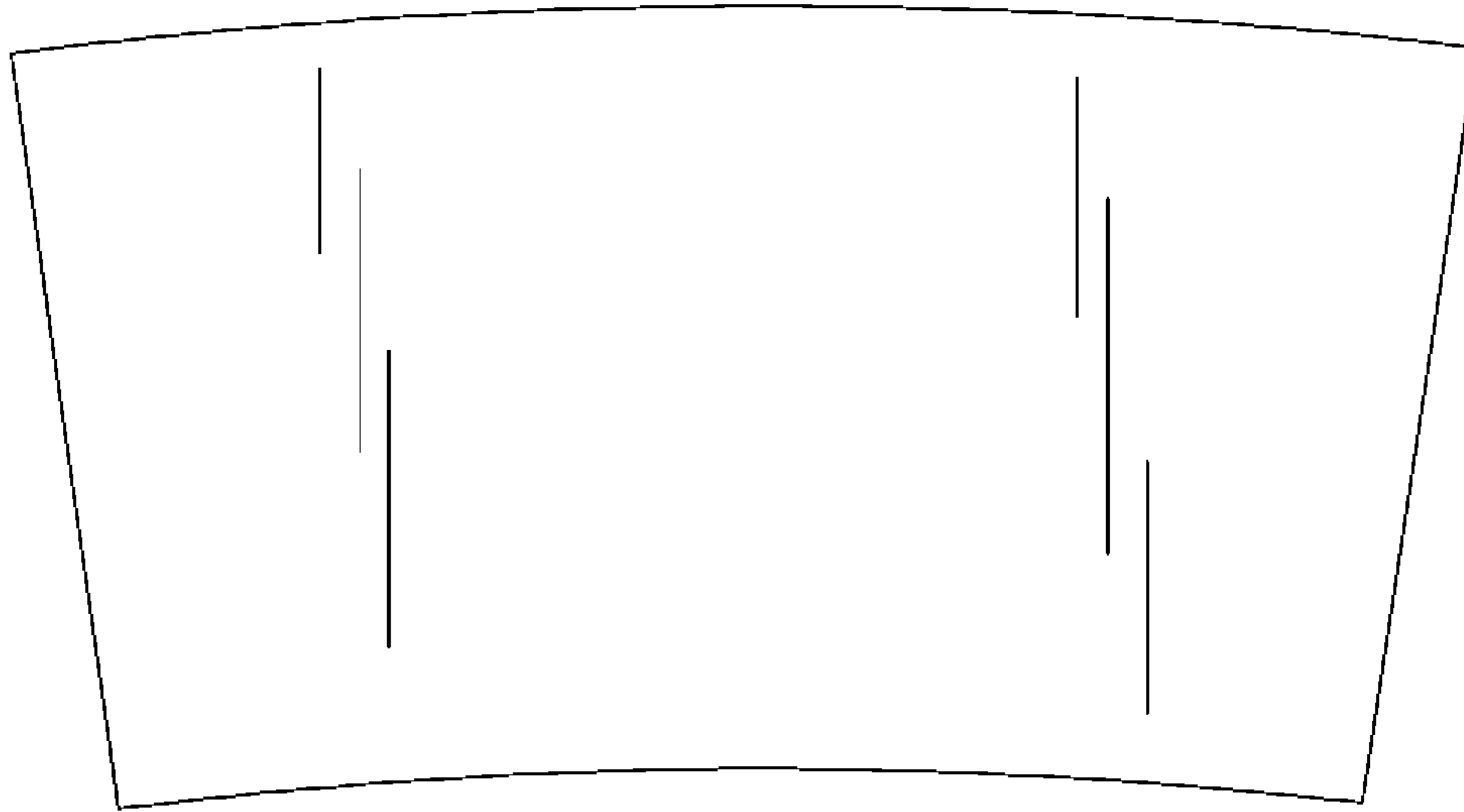

FIG. 9

FIG. 10

