



US00D720533S

(12) **United States Design Patent**
Kao et al.

(10) **Patent No.:** **US D720,533 S**
(45) **Date of Patent:** **** Jan. 6, 2015**

(54) **LUGGAGE BAG WITH REMOVABLE ORGANIZER**

Primary Examiner — Jennifer Rivard

Assistant Examiner — April Rivas

(74) *Attorney, Agent, or Firm* — David A. Crowther

(71) Applicant: **Origami, LLC**, Portland, OR (US)

(72) Inventors: **David Kao**, Portland, OR (US); **Richard P. Christen**, Bend, OR (US)

(73) Assignee: **Oregami, LLC**, Portland, OR (US)

(**) Term: **14 Years**

(21) Appl. No.: **29/457,468**

(22) Filed: **Jun. 10, 2013**

(51) **LOC (10) Cl.** **03-01**

(52) **U.S. Cl.**

USPC **D3/274**; D3/279; D3/289

(58) **Field of Classification Search**

CPC A45C 7/00; A45C 5/14; A45C 13/28;
A45C 5/03

USPC D3/273, 276, 279, 289, 301, 283, 272,
D3/278, 274, 281, 321, 902, 292, 232;
190/18 A, 100-127; 206/286-287.1;
D34/25

See application file for complete search history.

(56) **References Cited**

U.S. PATENT DOCUMENTS

3,530,961	A	9/1970	Weissenbach	
4,718,524	A	1/1988	Crumley	
4,887,751	A	12/1989	Lehman	
5,096,030	A	3/1992	Espinosa et al.	
5,624,026	A	4/1997	Chernoff	
6,168,022	B1	1/2001	Ward et al.	
6,382,377	B2 *	5/2002	Godshaw	190/110
6,523,653	B2	2/2003	Roegner	
D476,153	S *	6/2003	Sadr et al.	D3/279
6,604,618	B1 *	8/2003	Godshaw et al.	190/107
6,883,654	B2 *	4/2005	Godshaw et al.	190/115
7,044,277	B2 *	5/2006	Redzisz	190/107

(Continued)

(57) **CLAIM**

The ornamental design for a luggage bag with removable organizer, as shown and described.

DESCRIPTION

FIG. 1 is a perspective view of the luggage bag with removable organizer in a closed configuration;

FIG. 2 is a front view of FIG. 1;

FIG. 3 is a left side elevation view of FIG. 1;

FIG. 4 is a back view of FIG. 1;

FIG. 5 is a top view of FIG. 1;

FIG. 6 is a bottom view of FIG. 1;

FIG. 7 is a perspective view of the luggage bag in an open configuration with the removable organizer removed for convenience of illustration;

FIG. 8 is a front view of FIG. 7;

FIG. 9 is a bottom view of FIG. 7;

FIG. 10 is a top view of FIG. 7;

FIG. 11 is a right side elevation view of FIG. 7;

FIG. 12 is a left side elevation view of FIG. 7;

FIG. 13 is a back view of FIG. 7;

FIG. 14 is a perspective view of the luggage bag with removable organizer in an open configuration;

FIG. 15 is a top view of the removable organizer removed from the luggage bag for convenience of illustration;

FIG. 16 is a front view of FIG. 15; and,

FIG. 17 is a right side elevation view of FIG. 15.

The broken lines illustrate portions of the luggage bag with removable organizer and form no part of the claimed design.

The figures in which the bag and organizer appear independently are for convenience of illustration only.

1 Claim, 10 Drawing Sheets

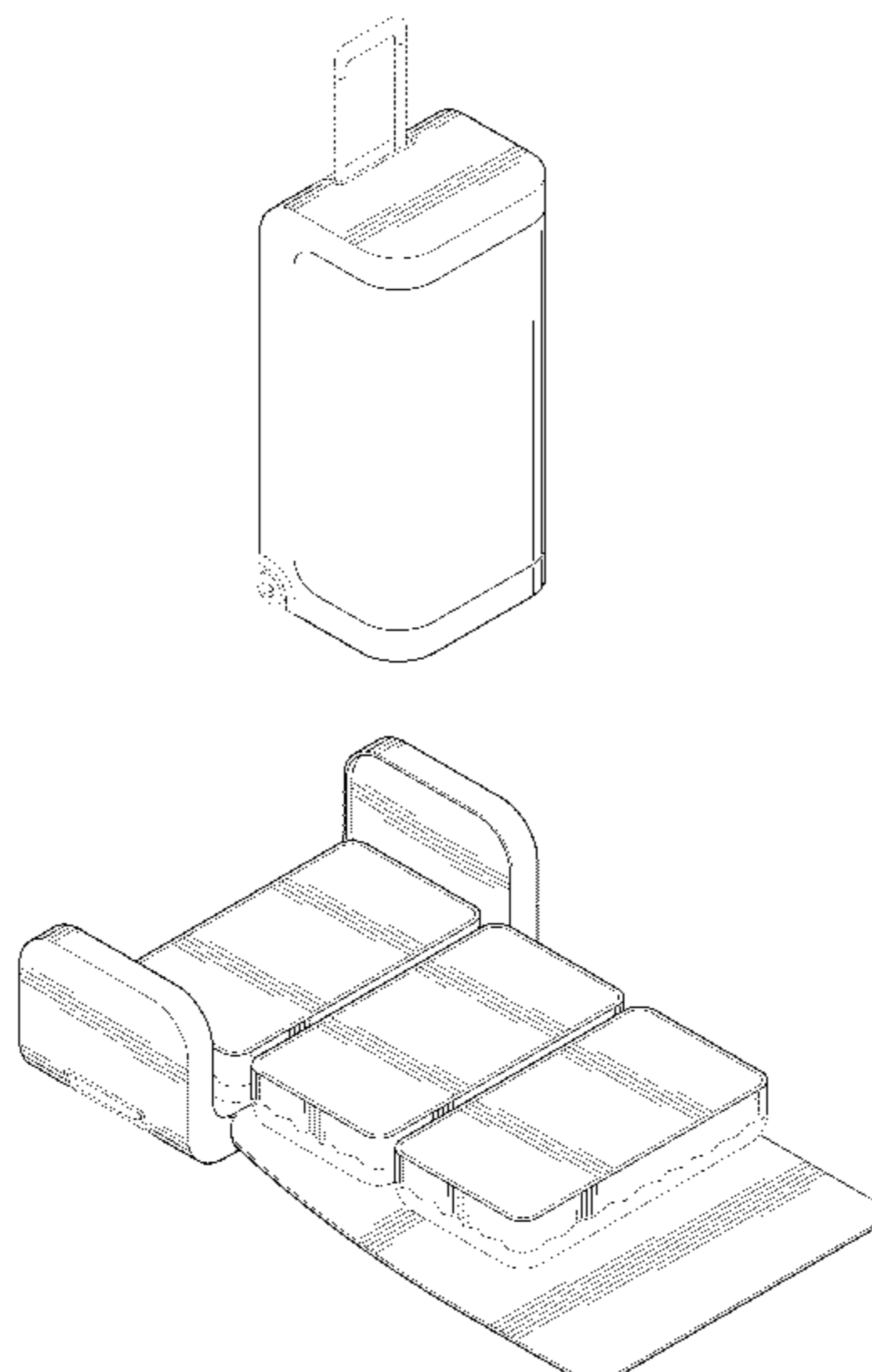

(56)

References Cited

U.S. PATENT DOCUMENTS

D552,349 S *	10/2007	Greiner	D3/279	7,861,857 B2 *	1/2011	Vorderkunz	206/289
D566,393 S *	4/2008	Kidakarn	D3/283	D646,059 S *	10/2011	Park	D3/289
D573,793 S *	7/2008	Bakker	D3/301	D688,458 S *	8/2013	Harris	D3/285
7,416,066 B2 *	8/2008	Chernoff	190/108	2004/0007433 A1 *	1/2004	Godshaw et al.	190/18 A
				2004/0173427 A1	9/2004	Chernoff	
				2007/0044877 A1	3/2007	Davidoff et al.	
				2013/0264162 A1 *	10/2013	Kogelnik	190/108

* cited by examiner

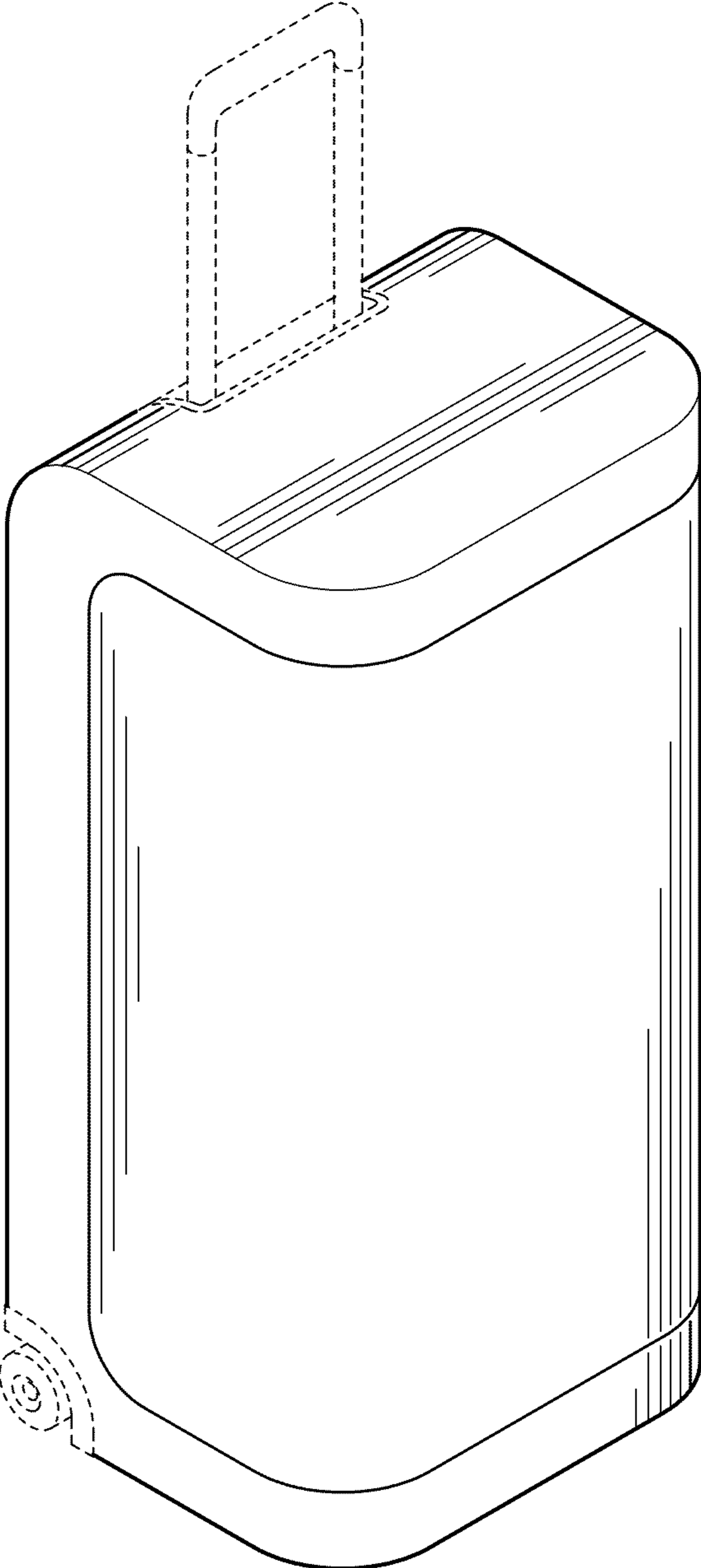

FIG. 1

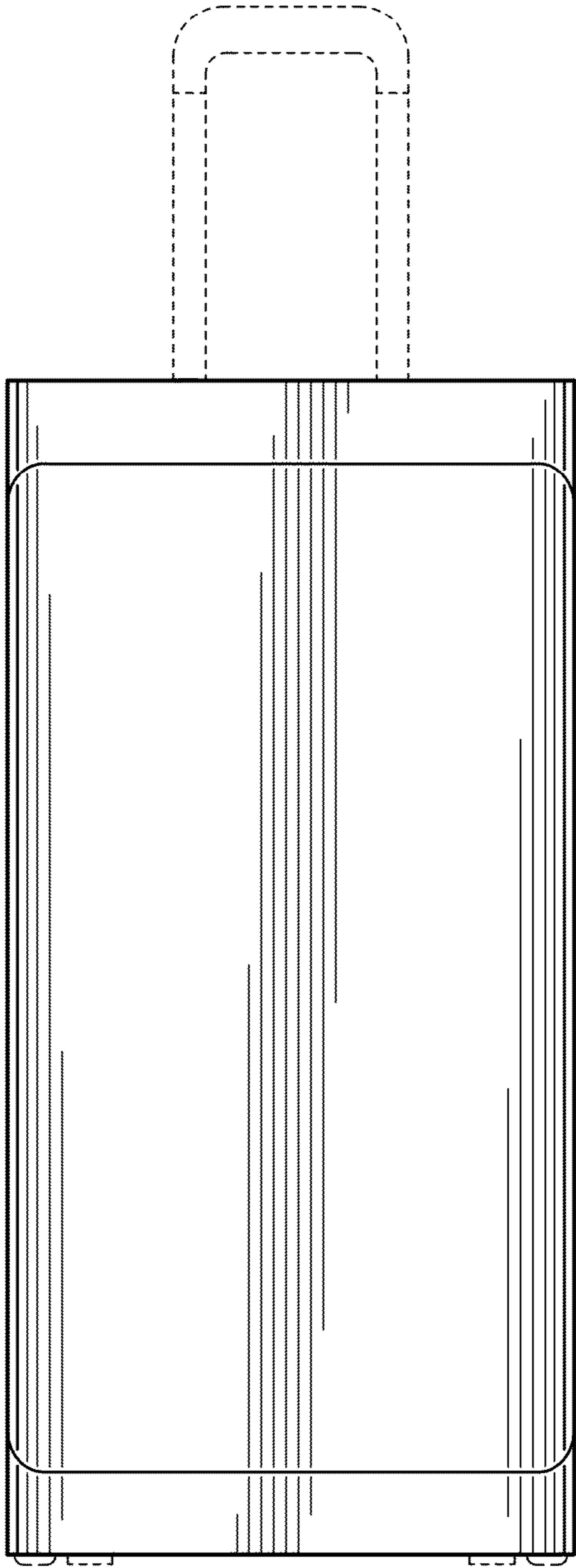

FIG. 2

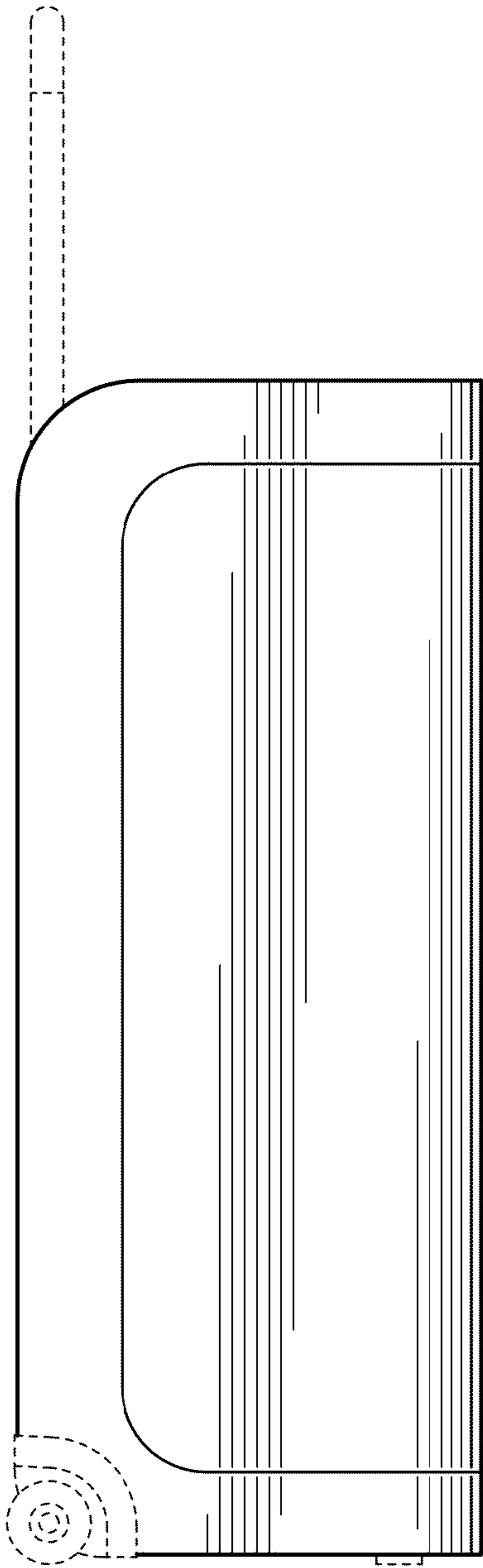

FIG. 3

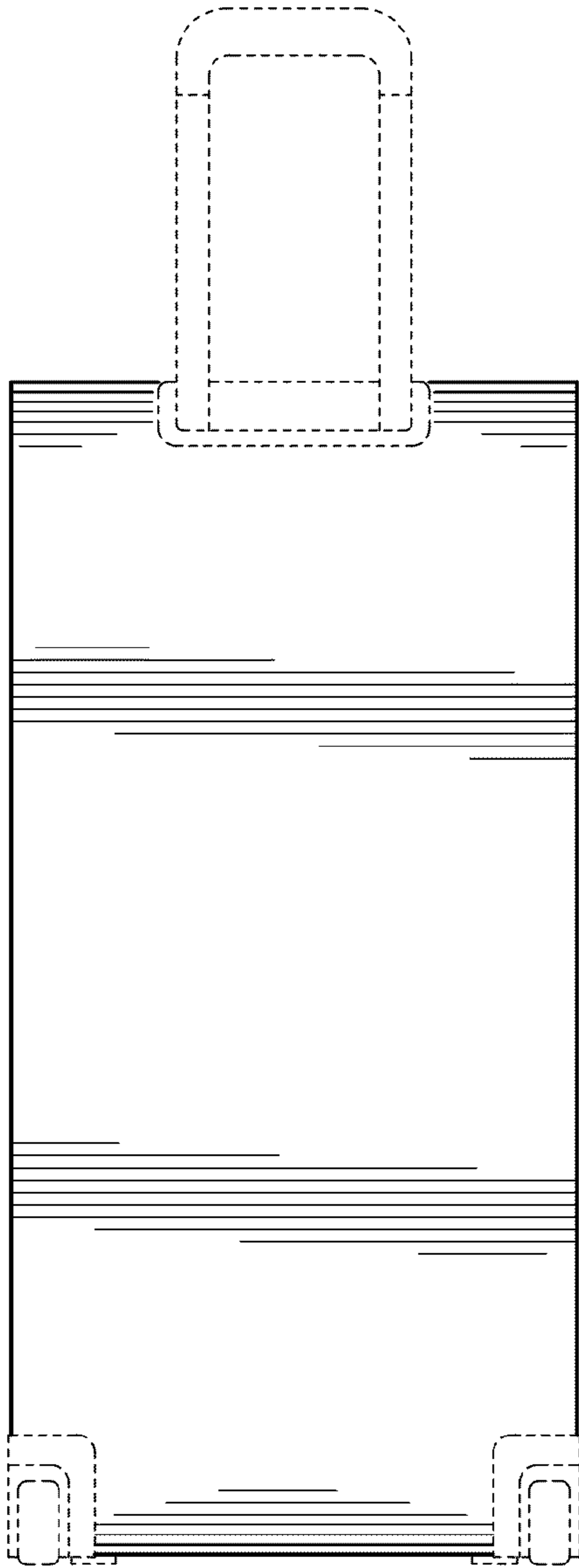

FIG. 4

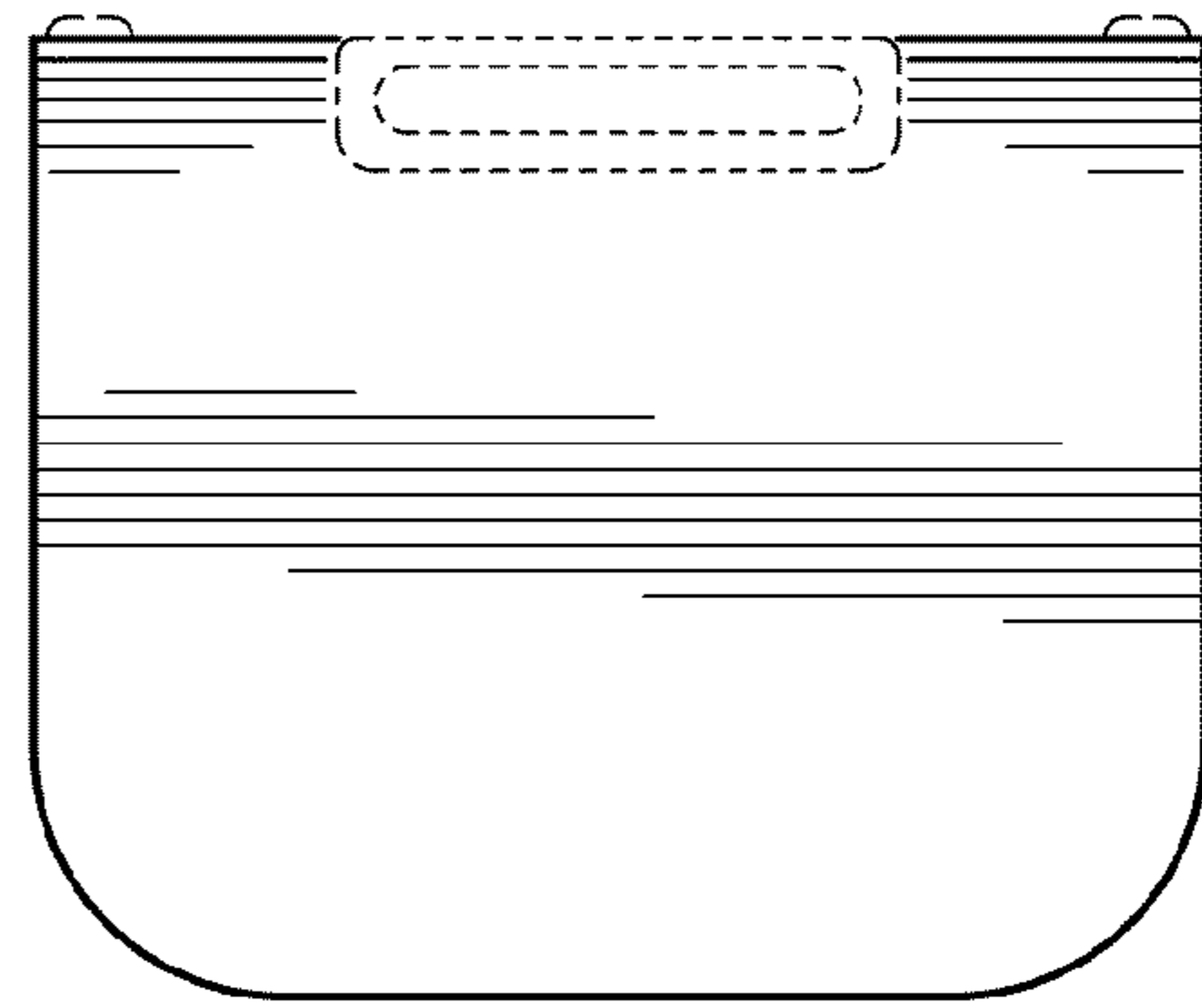

FIG. 5

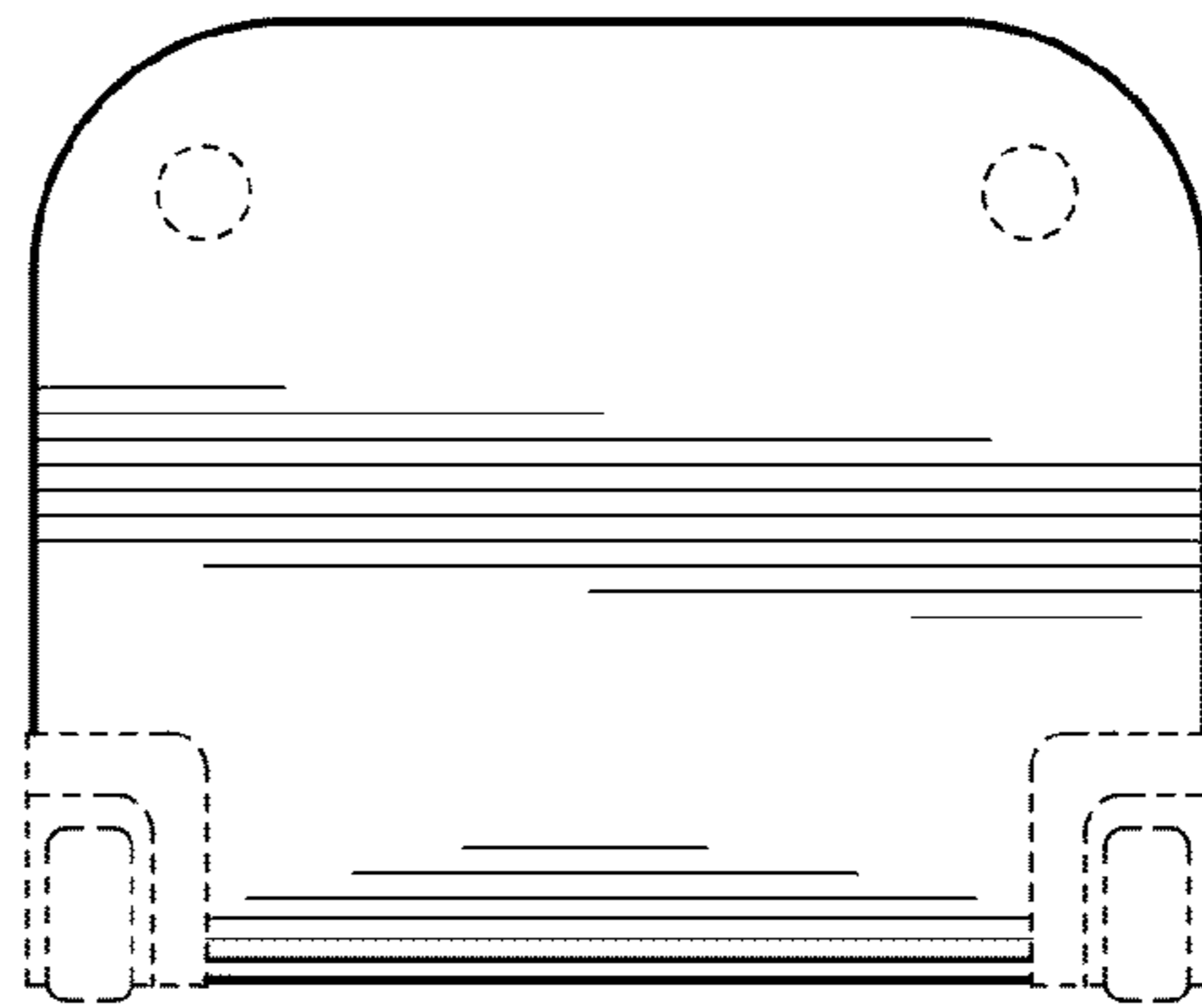

FIG. 6

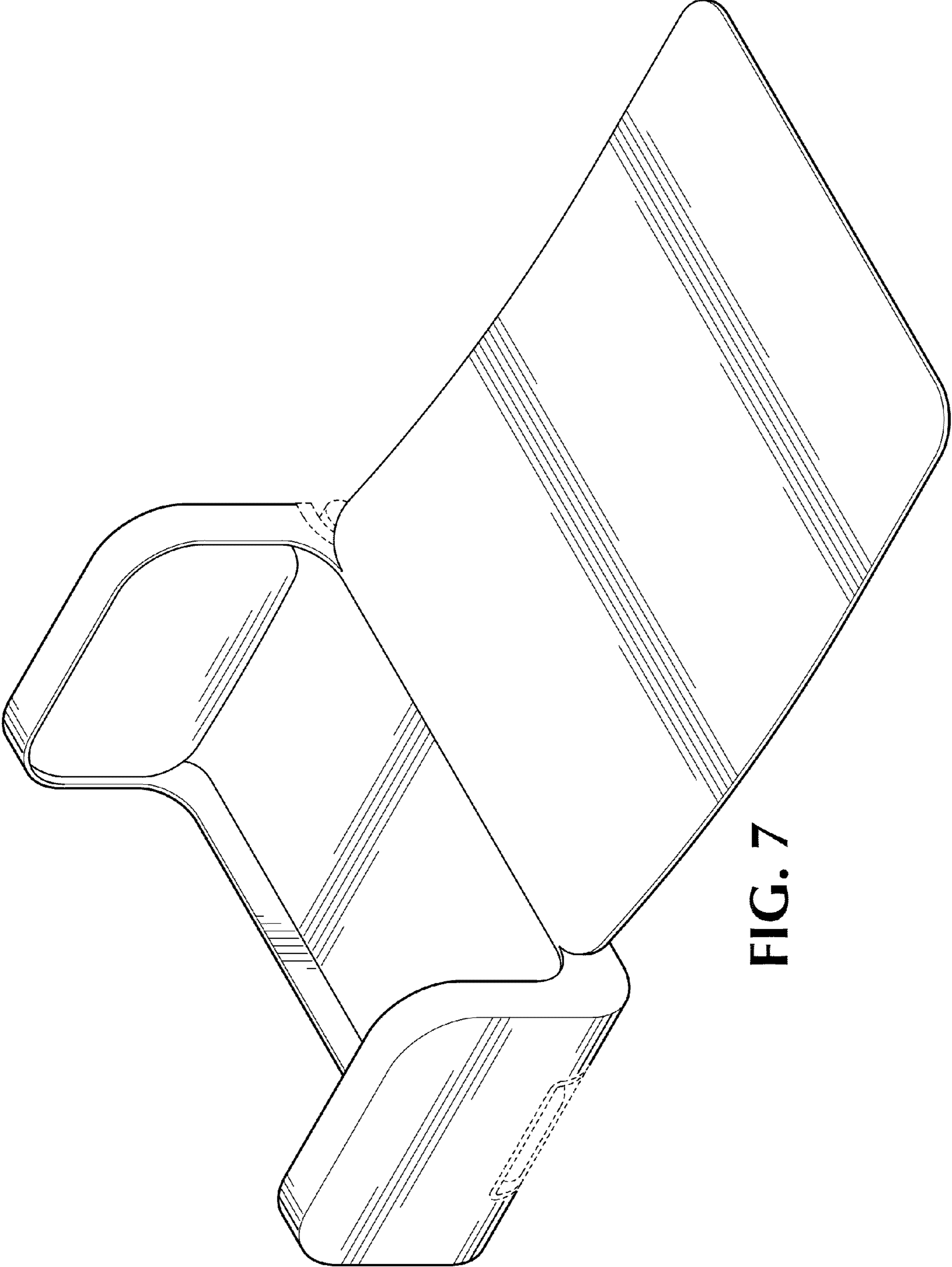

FIG. 7

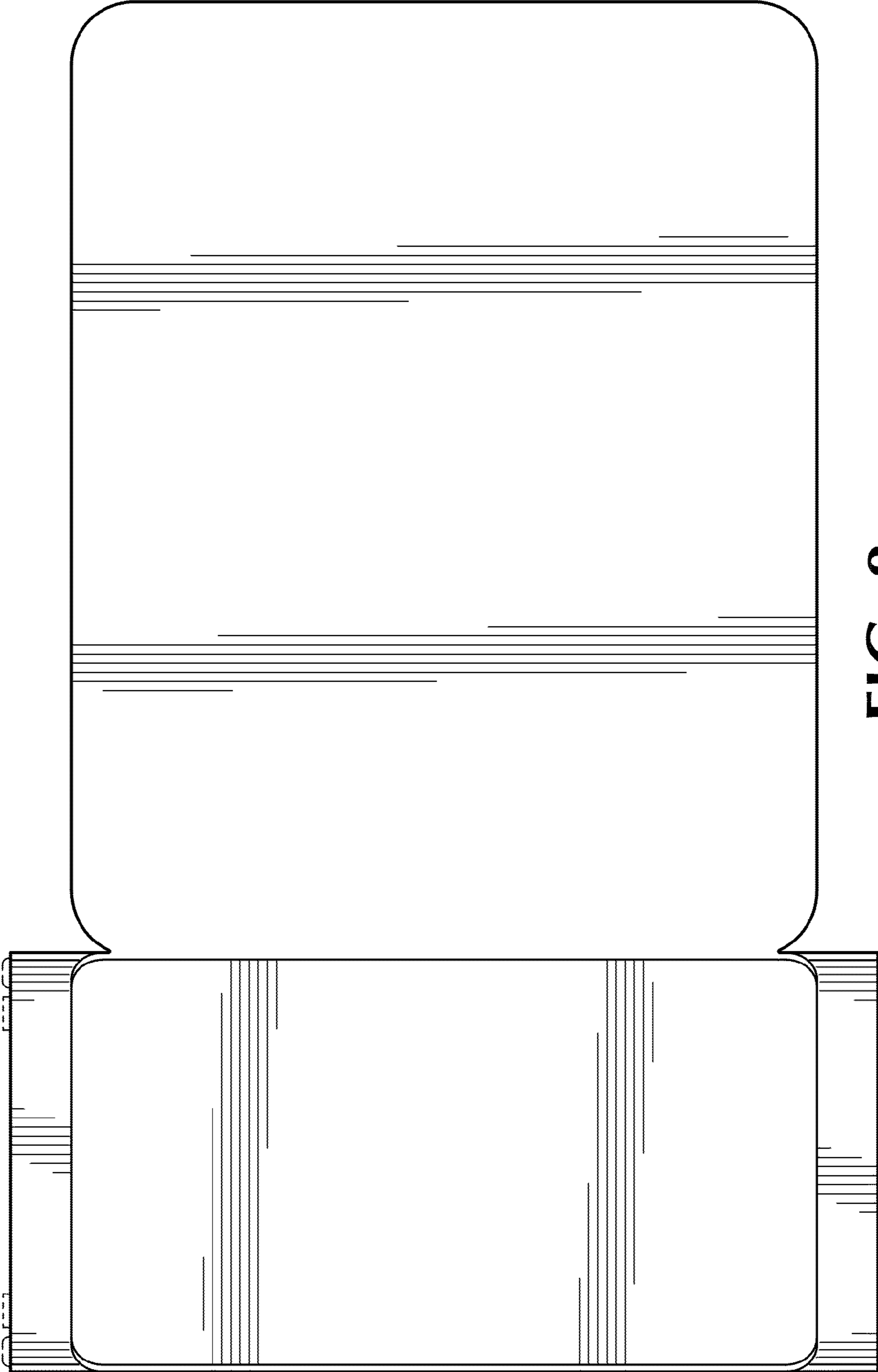

FIG. 8

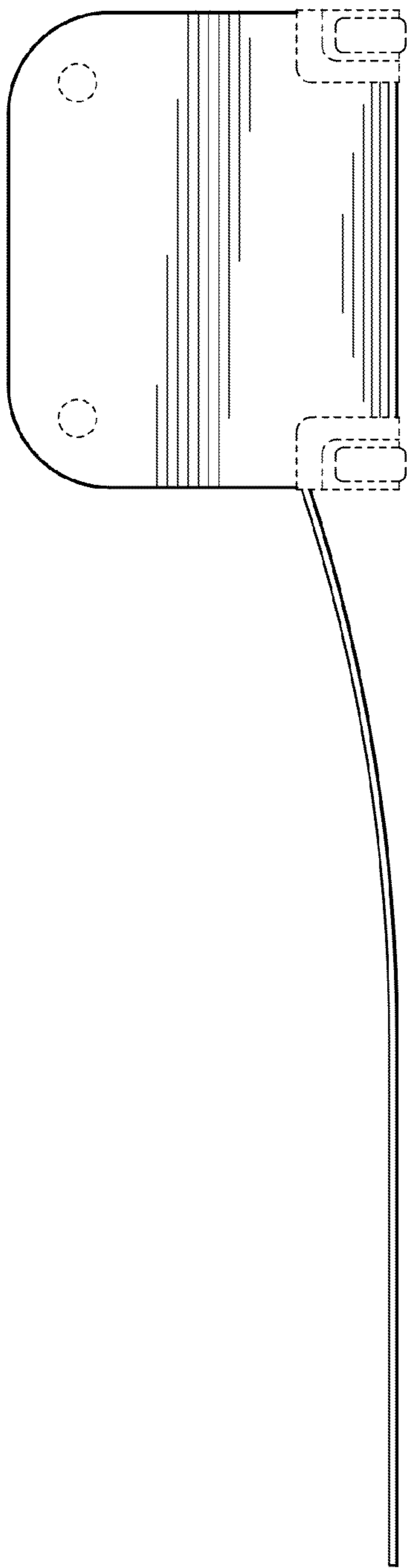

FIG. 9

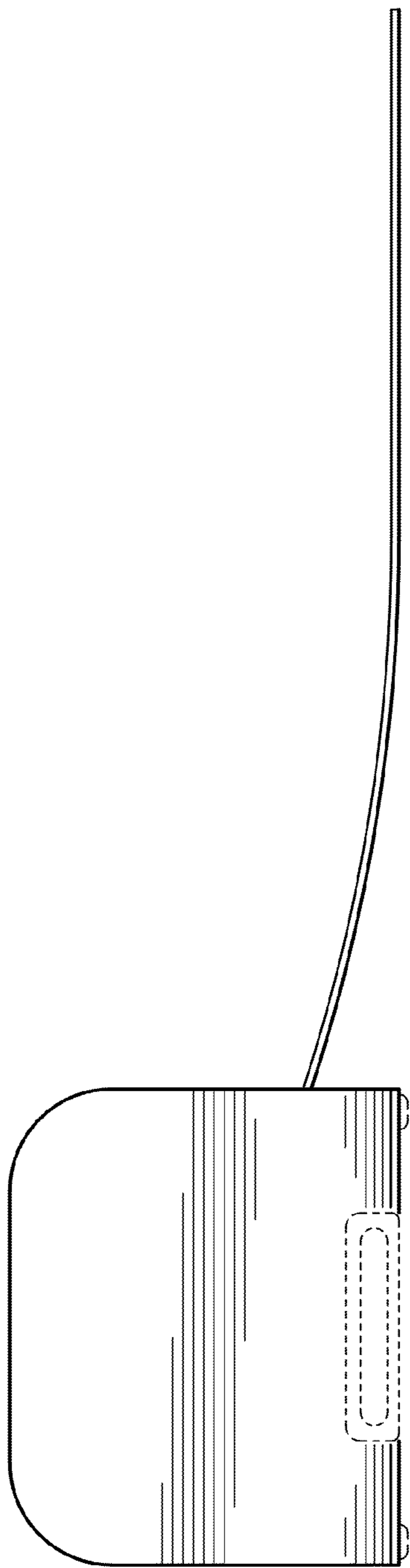

FIG. 10

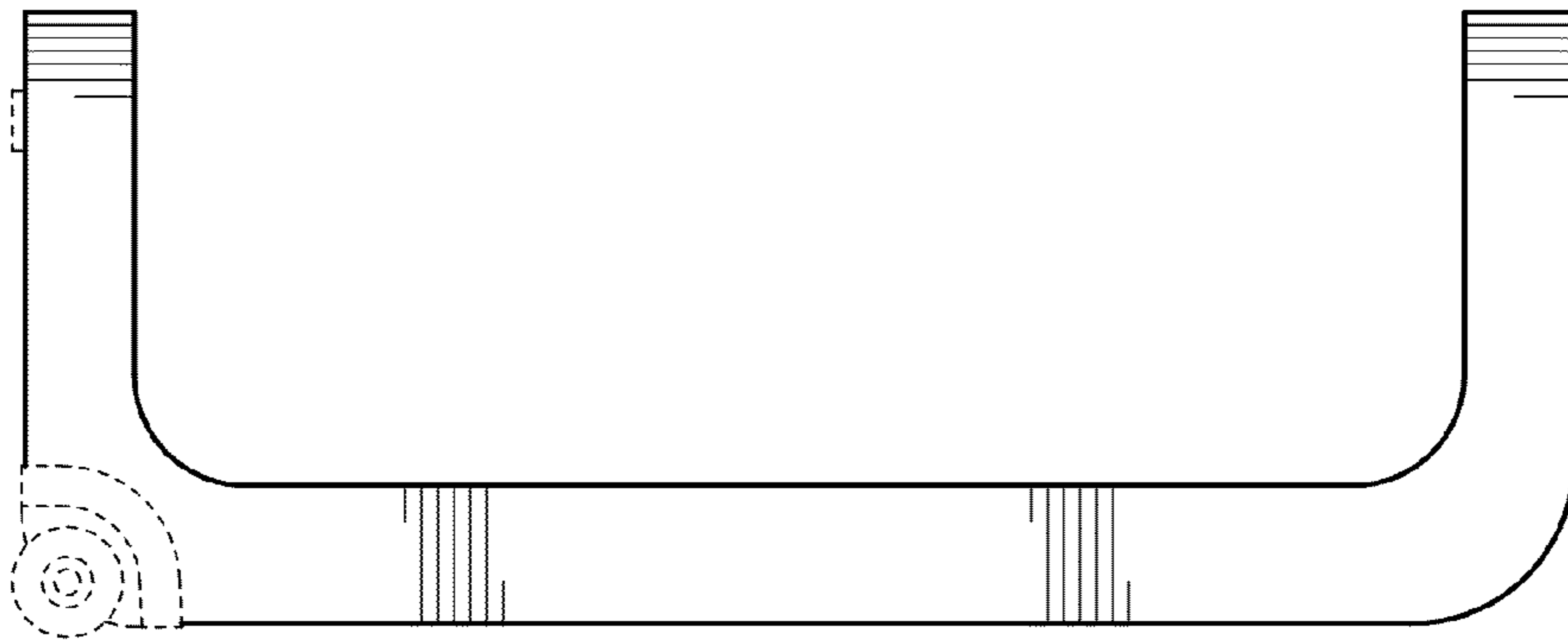

FIG. 11



FIG. 12

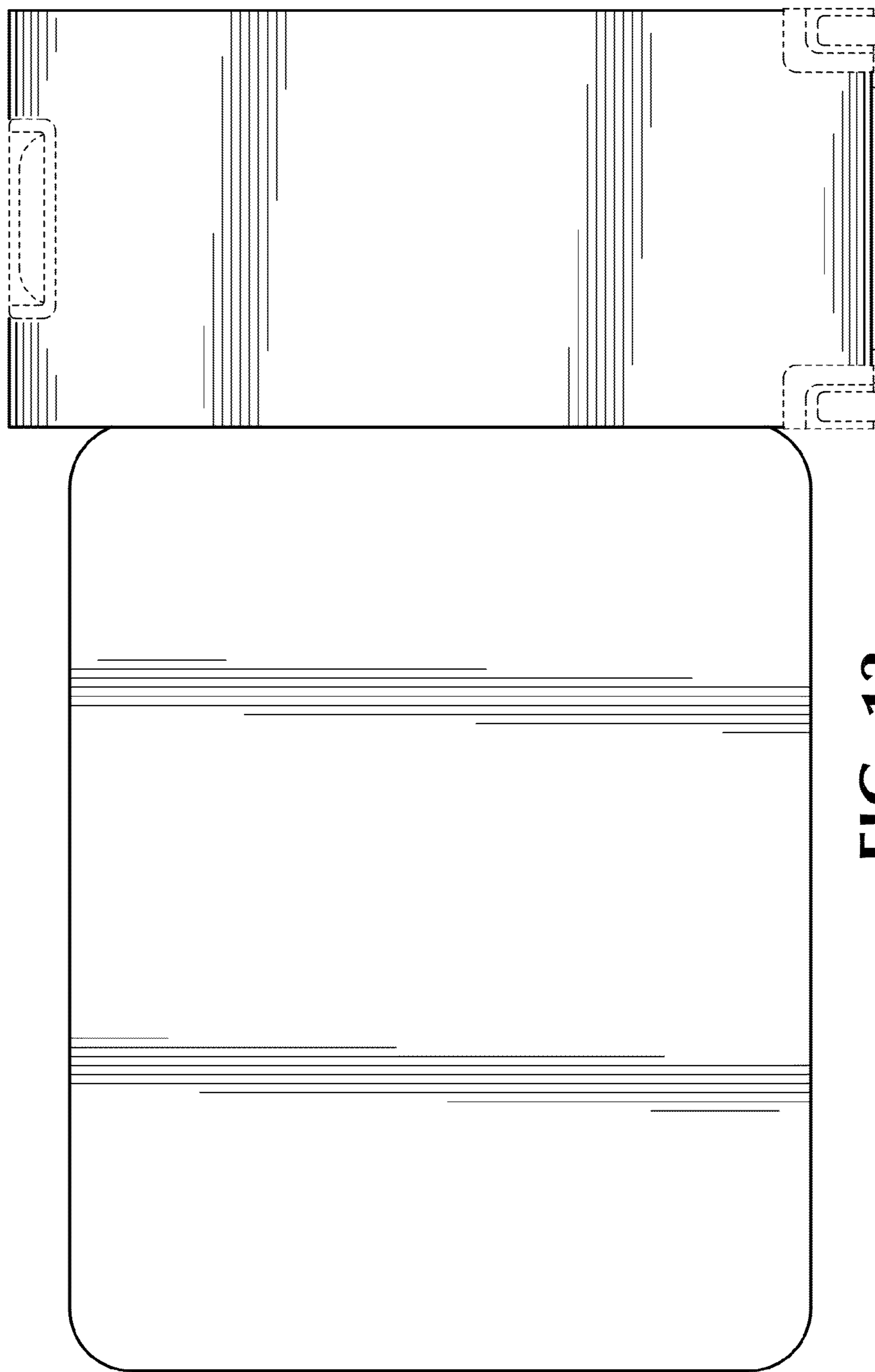

FIG. 13

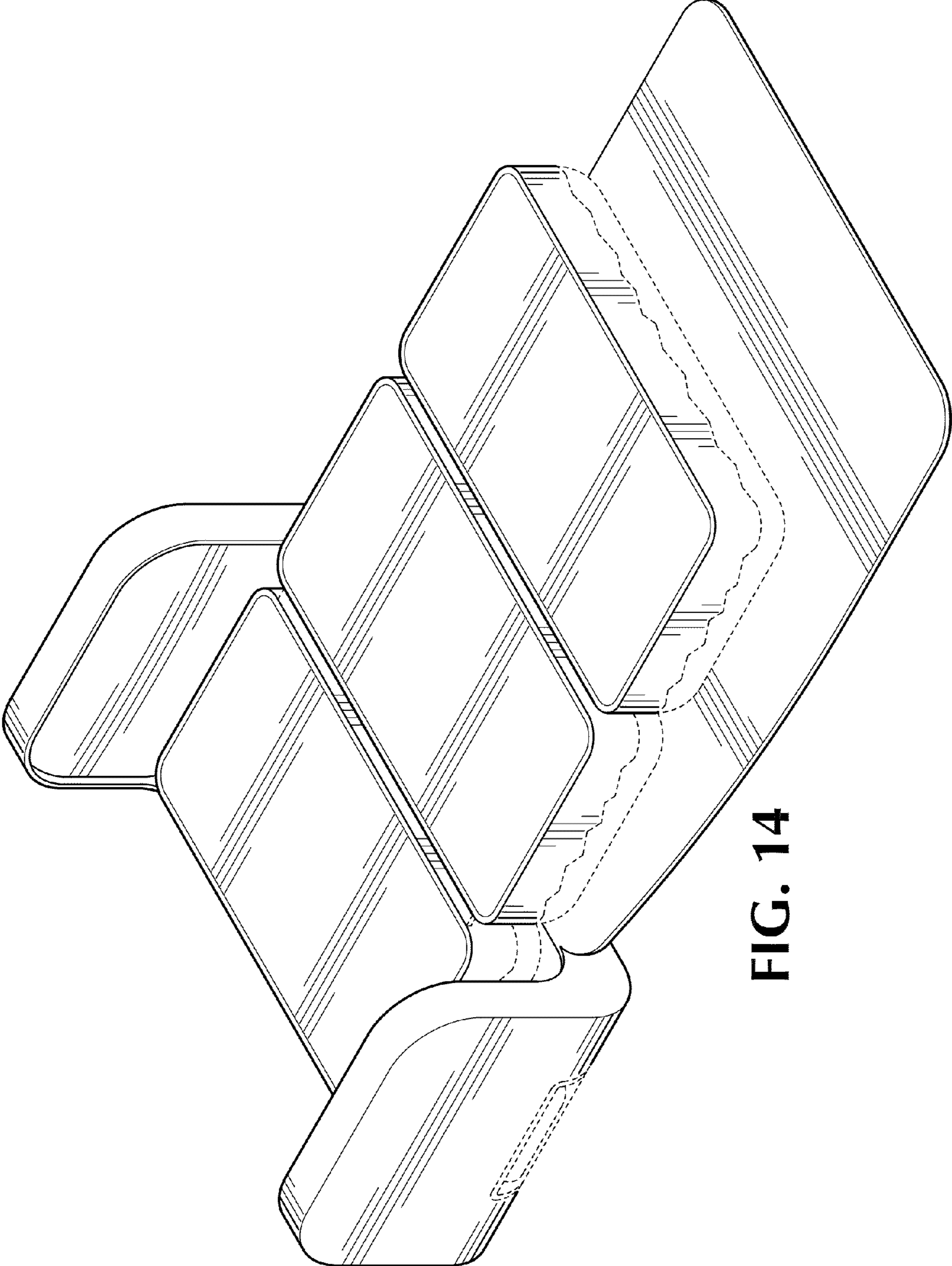

FIG. 14

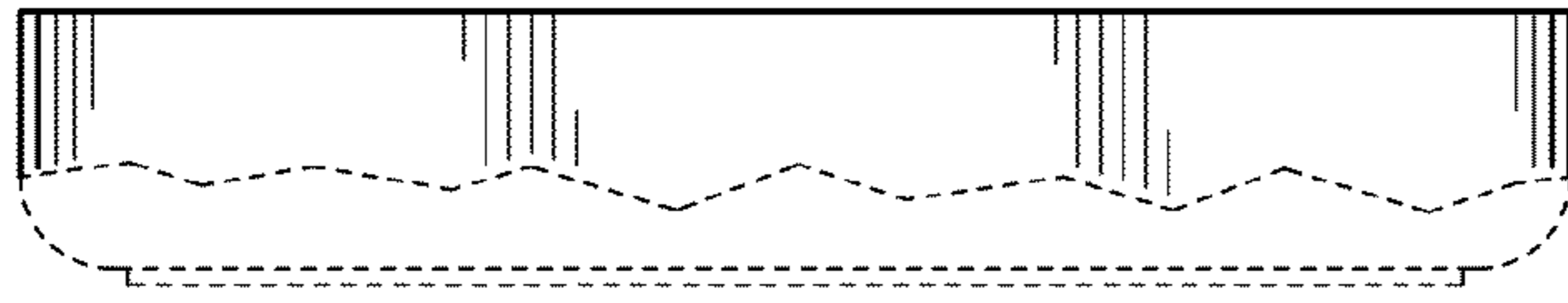

FIG. 15

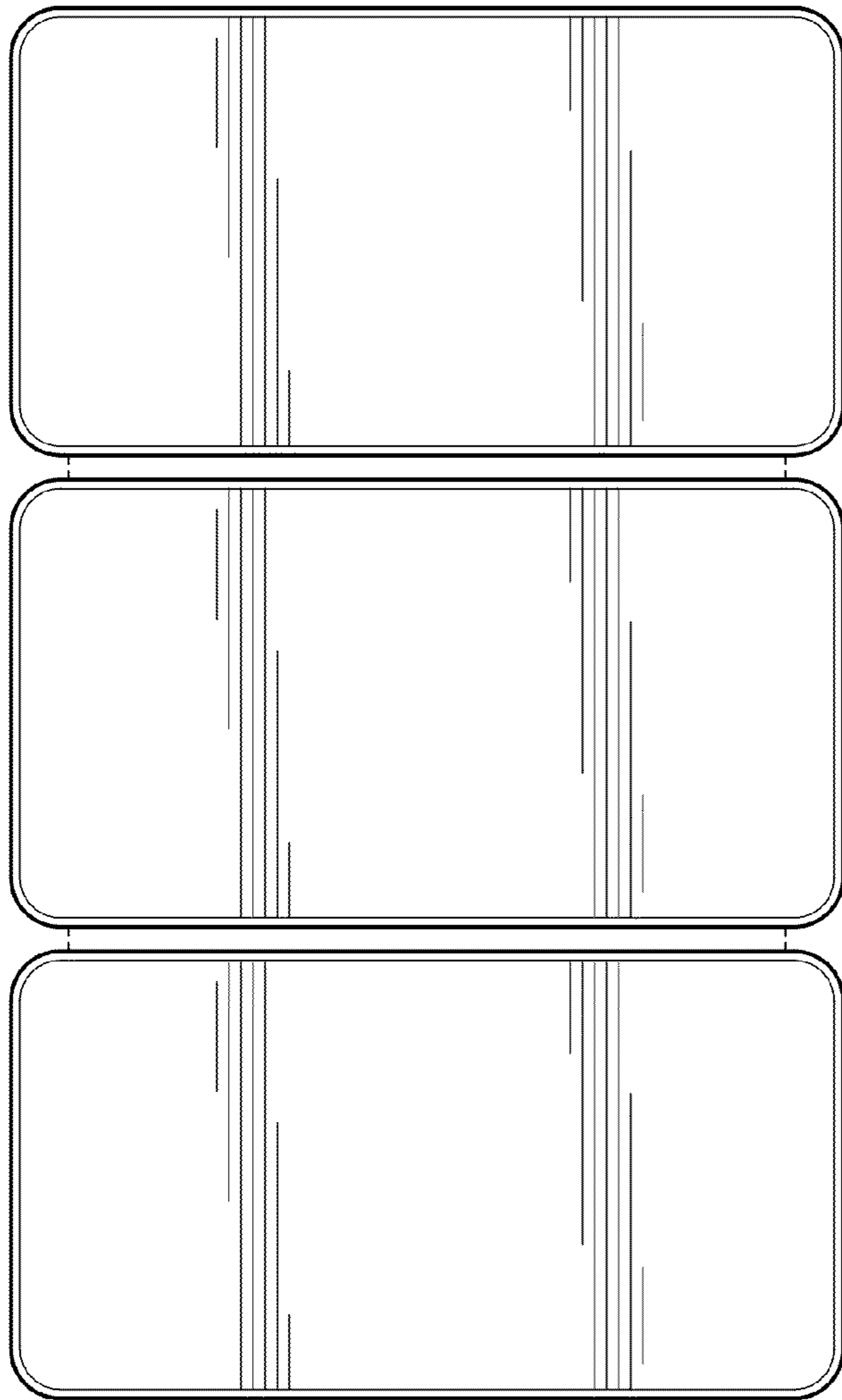

FIG. 16

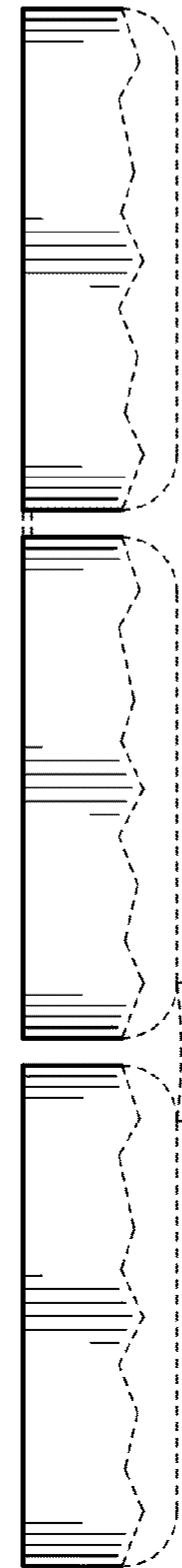

FIG. 17