



US00D720101S

(12) **United States Design Patent**  
**Erlich et al.**

(10) **Patent No.:** **US D720,101 S**  
(45) **Date of Patent:** **\*\* Dec. 23, 2014**

(54) **HAND-HELD SUBMERSIBLE POOL AND SPA VACUUM CLEANER**

(71) Applicant: **Water Tech LLC**, East Brunswick, NJ (US)

(72) Inventors: **Guy Erlich**, Monroe Township, NJ (US);  
**Jon Elmaleh**, Brooklyn, NY (US);  
**James Kosmyna**, Old Bridge, NJ (US)

(73) Assignee: **Water Tech LLC**, East Brunswick, NJ (US)

(\*\*) Term: **14 Years**

(21) Appl. No.: **29/460,651**

(22) Filed: **Jul. 12, 2013**

(51) **LOC (10) Cl.** ..... **15-05**

(52) **U.S. Cl.**  
USPC ..... **D32/18**

(58) **Field of Classification Search**  
USPC ..... D32/18, 21, 22, 31; 15/1, 7, 344;  
210/167.1, 241, 167.12, 167.15,  
210/167.16  
See application file for complete search history.

(56) **References Cited**

**U.S. PATENT DOCUMENTS**

5,338,446	A	8/1994	Schuman et al.	
5,970,557	A	10/1999	Supra	
D443,960	S	6/2001	Shimko et al.	
D468,496	S	1/2003	Smith	
D485,652	S *	1/2004	Erlich	D32/18
D518,253	S *	3/2006	Erlich et al.	D32/18
D522,191	S *	5/2006	Erlich	D32/18
D528,715	S	9/2006	Carr	
D556,396	S *	11/2007	Mah et al.	D32/18
D569,058	S	5/2008	Crawley	
D579,161	S *	10/2008	Crawley	D32/18
7,636,975	B2 *	12/2009	Mah et al.	15/1.7
D620,652	S	7/2010	Butts et al.	
D640,848	S	6/2011	Houghton	
D653,008	S *	1/2012	Houghton	D32/18
D660,526	S *	5/2012	Erlich et al.	D32/18

D682,493	S *	5/2013	Erlich et al.	D32/18
D685,542	S *	7/2013	Erlich et al.	D32/18
2004/0079690	A1 *	4/2004	Erlich	210/169
2004/0117940	A1	6/2004	Kim	
2005/0035039	A1	2/2005	Erlich	
2006/0265820	A1 *	11/2006	Erlich et al.	15/1.7
2008/0109972	A1 *	5/2008	Mah et al.	15/1.7
2012/0030898	A1 *	2/2012	Crouch et al.	15/344

\* cited by examiner

*Primary Examiner* — Ruth McInroy

(74) *Attorney, Agent, or Firm* — Abelman, Frayne & Schwab

(57) **CLAIM**

The ornamental design for a hand-held submersible pool and spa vacuum cleaner, as shown and described.

**DESCRIPTION**

FIG. 1 is a top, rear, right side perspective view of a first embodiment of a hand-held submersible pool and spa vacuum cleaner showing our new design; FIG. 2 is a top plan view thereof; FIG. 3 is a right side elevational view thereof; FIG. 4 is a front elevational view thereof; FIG. 5 is a left side elevational view thereof; FIG. 6 is a rear elevational view thereof; FIG. 7 is a bottom plan view thereof; FIG. 8 is a top, rear, right side perspective view of a second embodiment of the hand-held submersible pool and spa vacuum cleaner showing our new design and being the same as the first embodiment except with a forward housing portion being transparent; FIG. 9 is a top plan view thereof; FIG. 10 is a right side elevational view thereof; FIG. 11 is a front elevational view thereof; FIG. 12 is a left side elevational view thereof; FIG. 13 is a rear elevational view thereof; and, FIG. 14 is a bottom plan view thereof.

The broken lines showing structural features are included for the purpose of illustrating non-claimed subject matter and form no part of the claimed design.

**1 Claim, 14 Drawing Sheets**

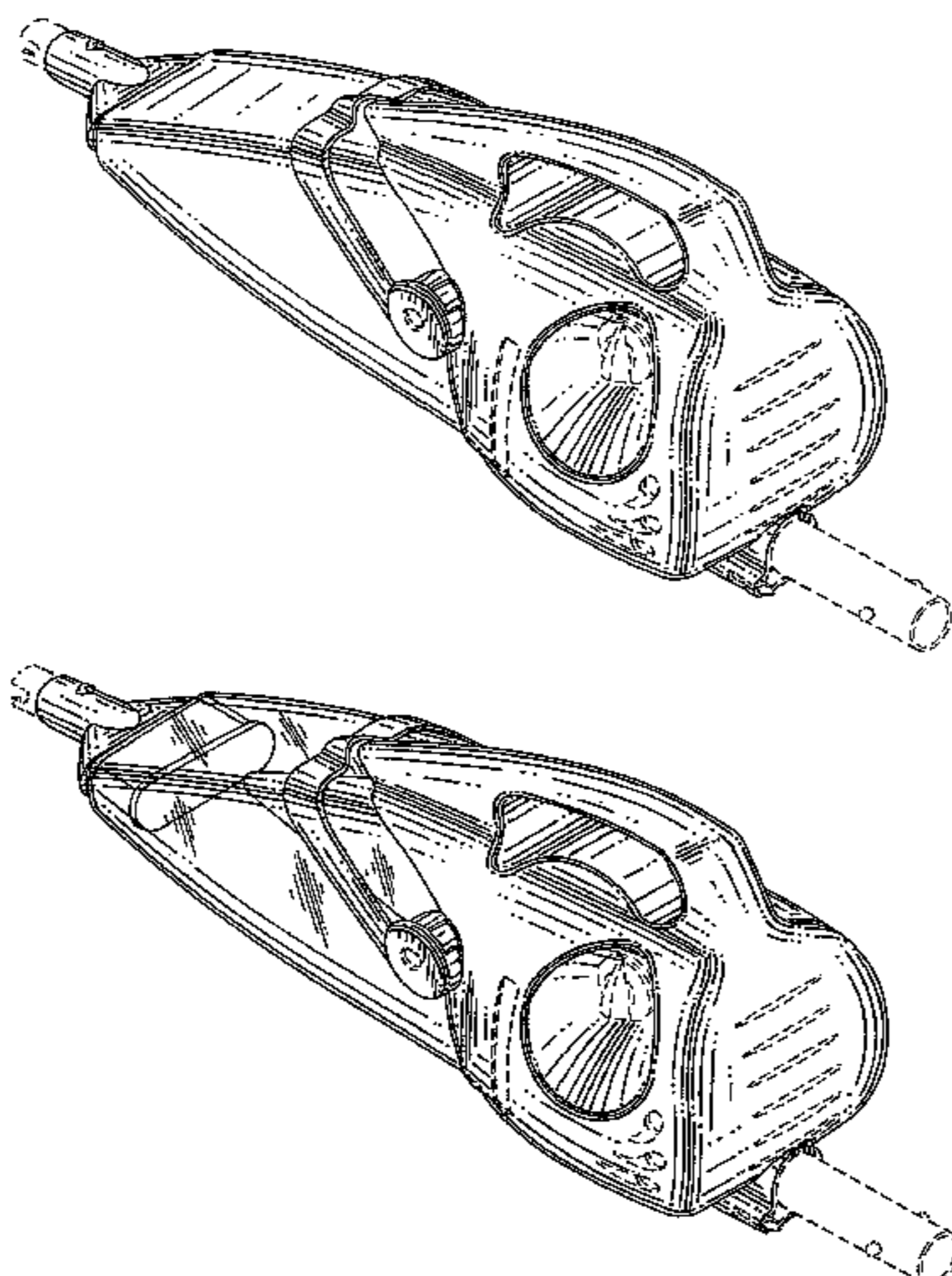

FIG. 1

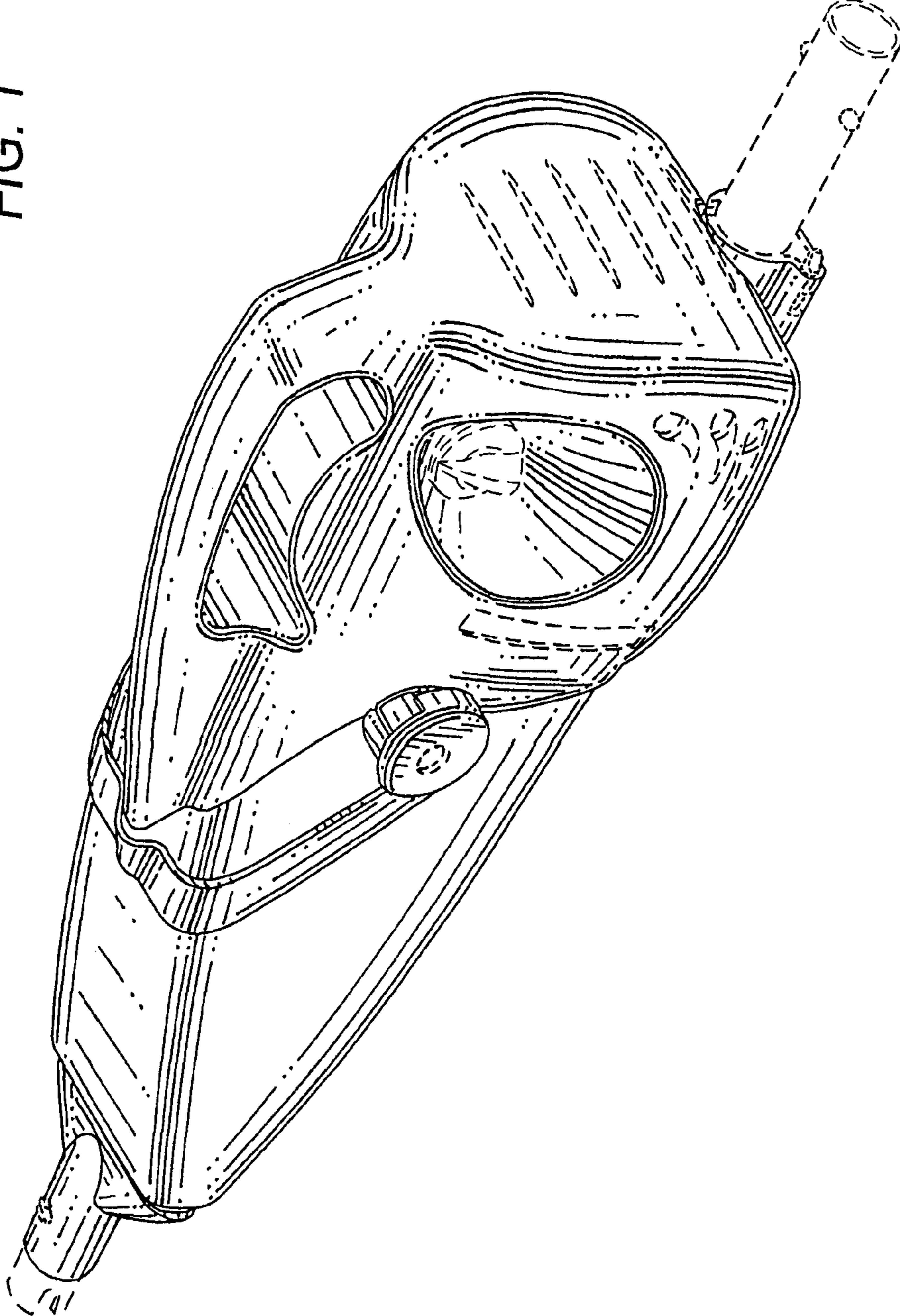
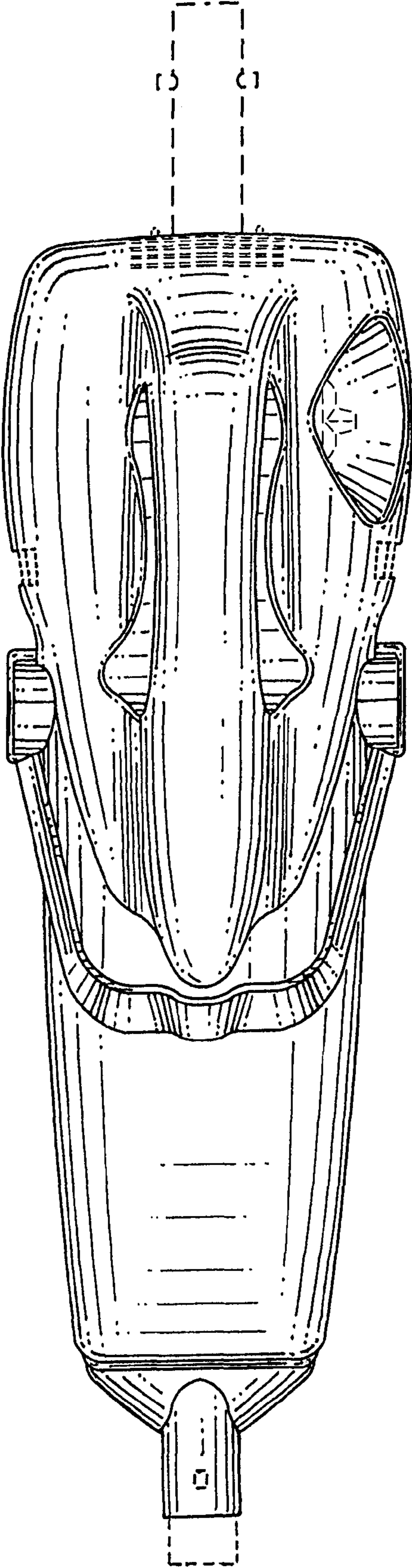

FIG. 2



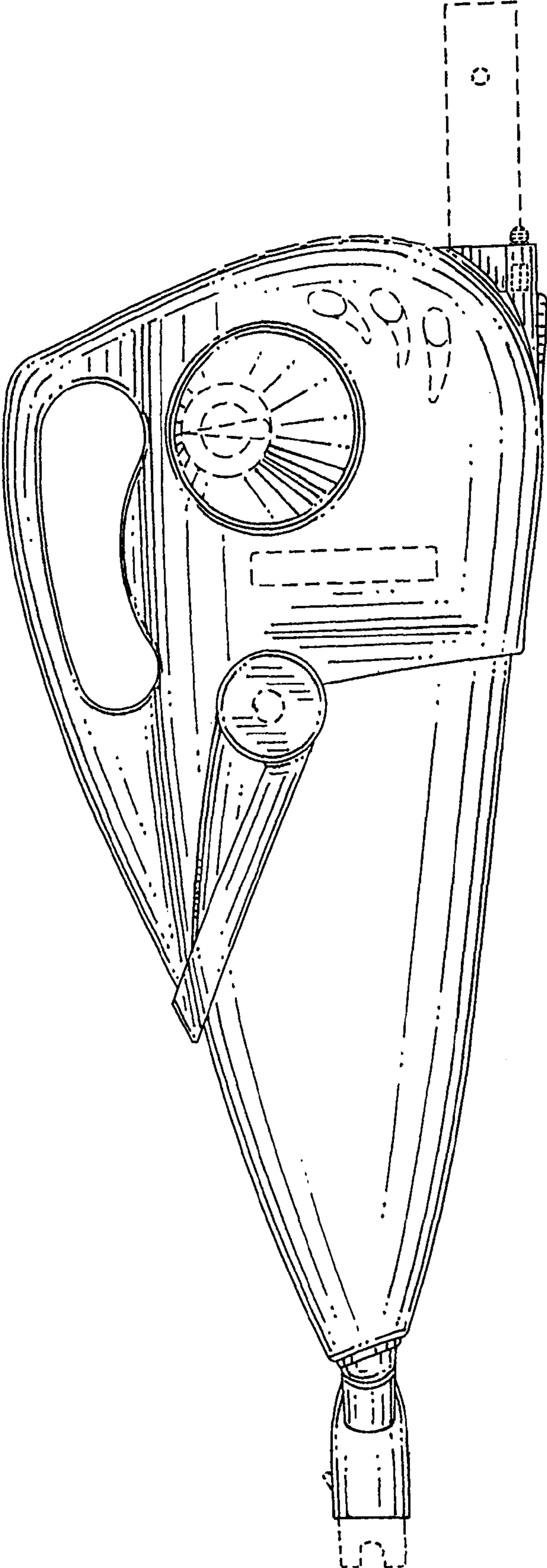

FIG. 3

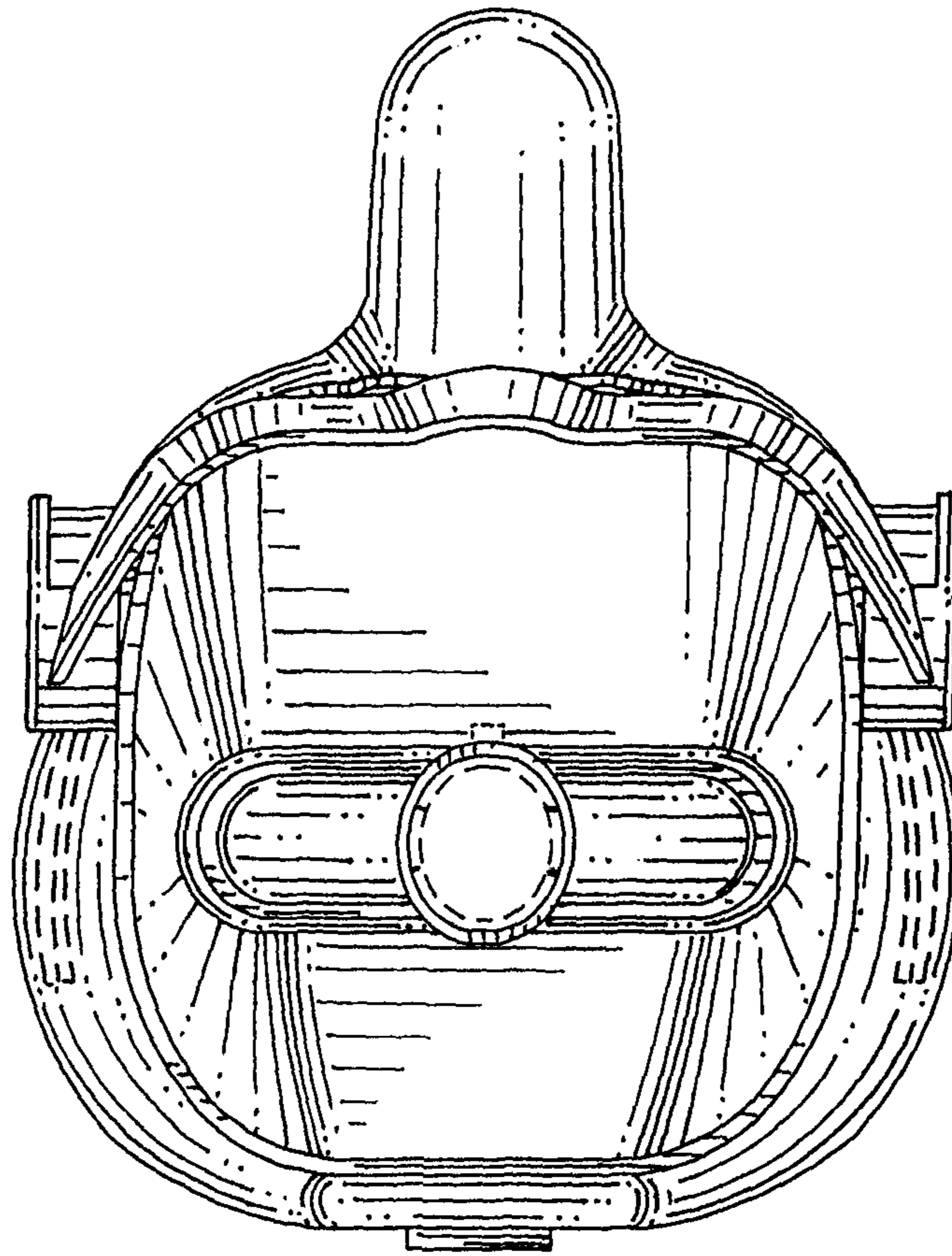
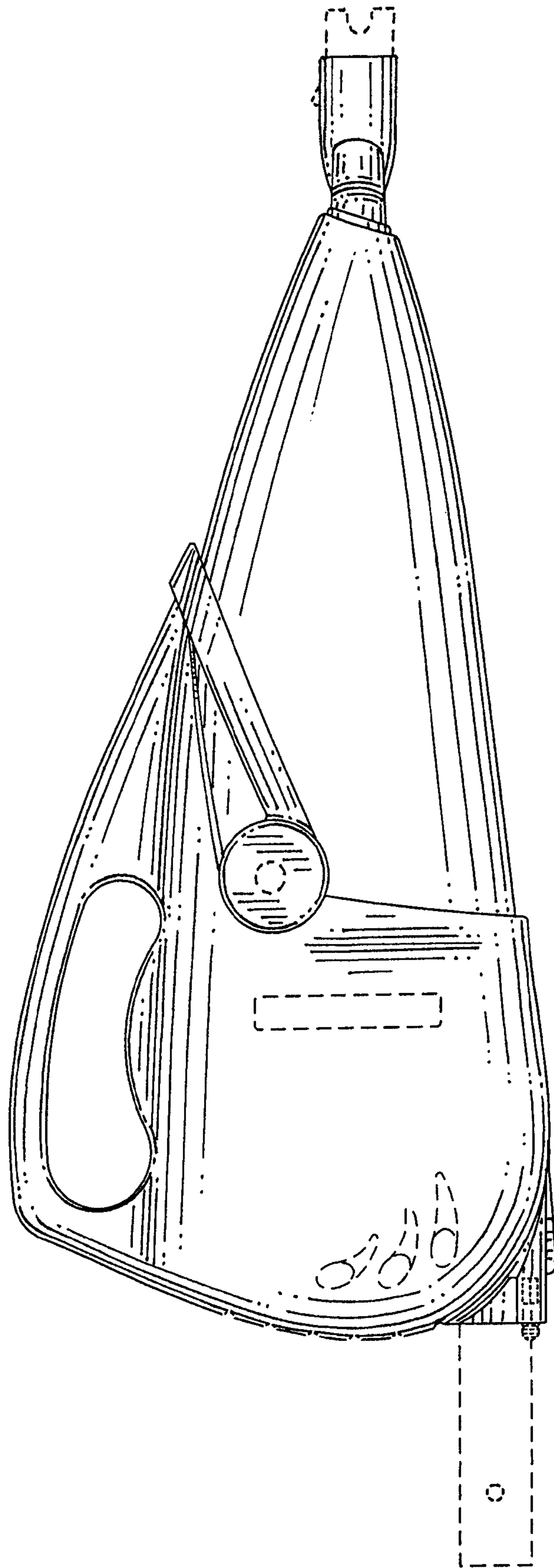

FIG. 4

FIG. 5



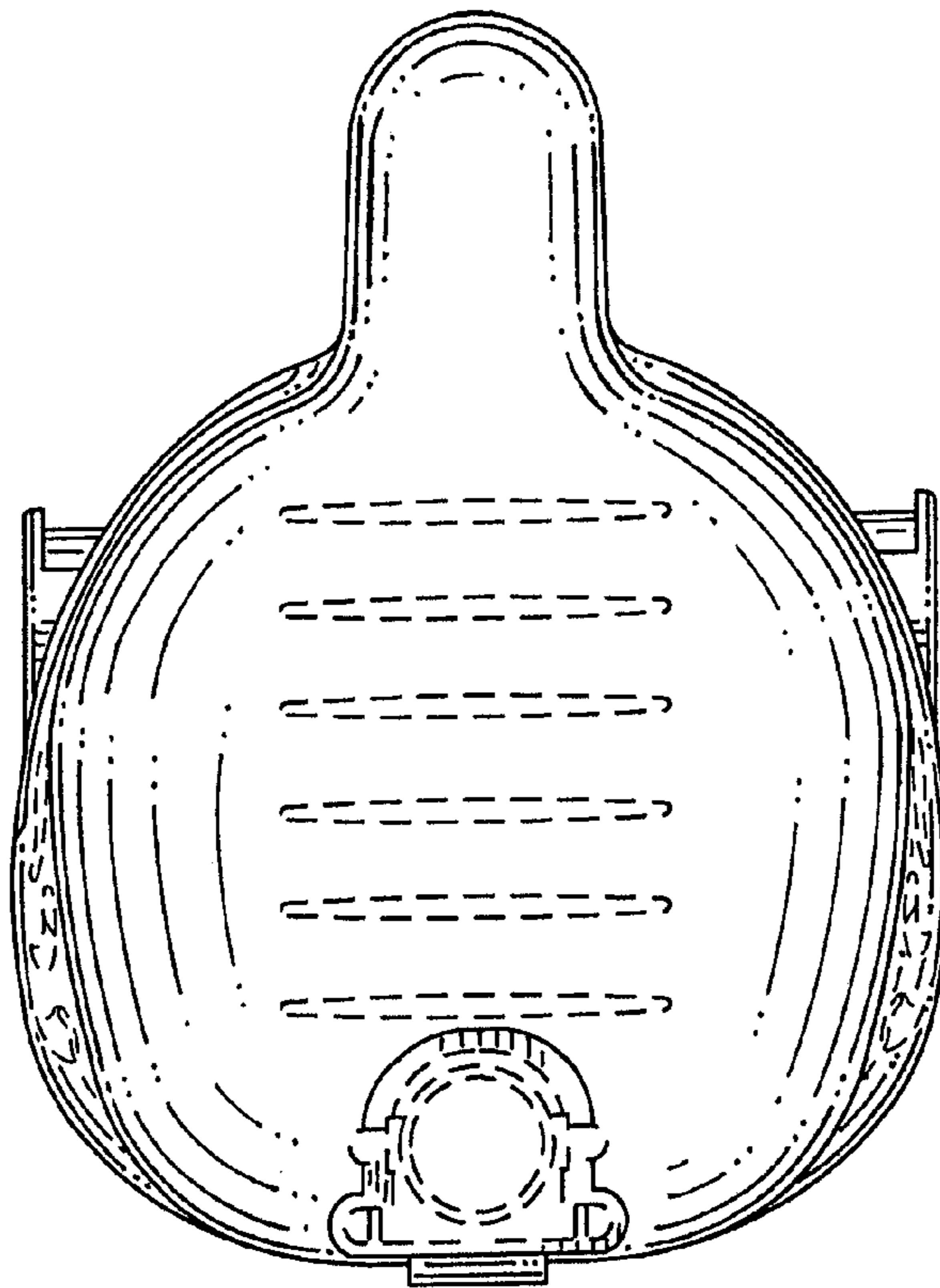

FIG. 6

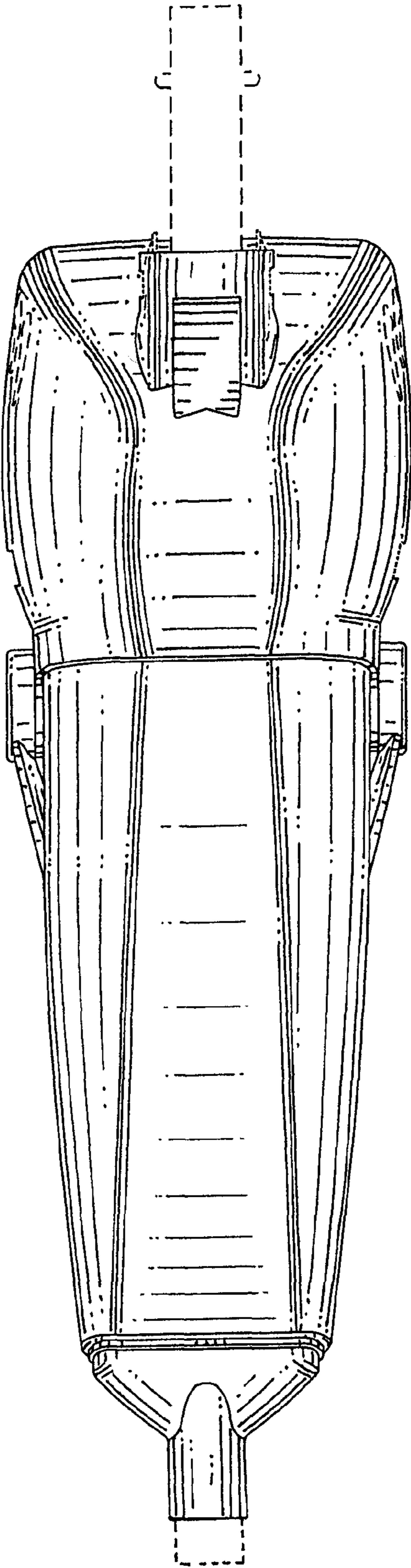

FIG. 7



FIG. 8

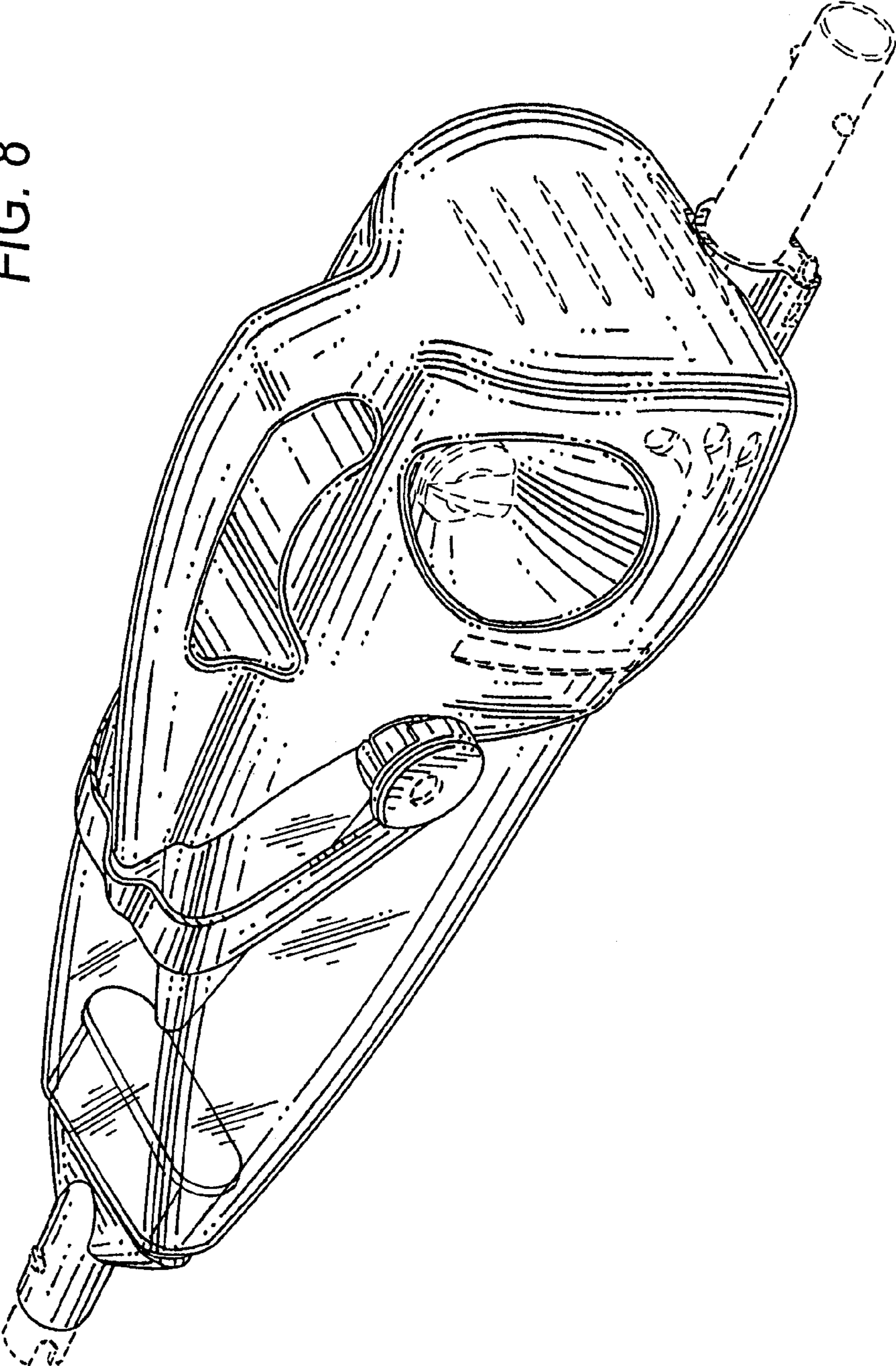
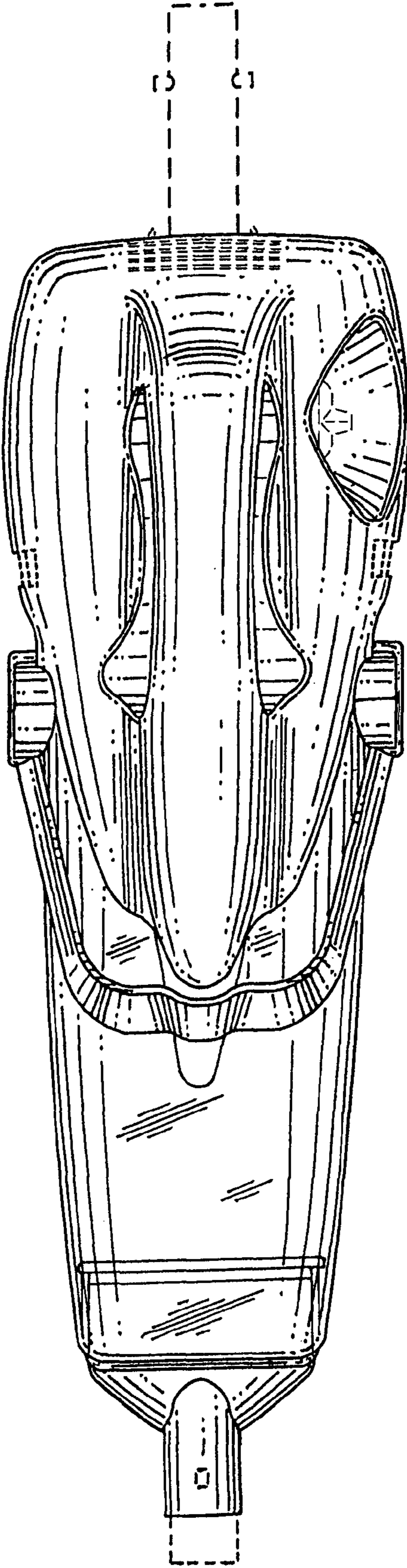

FIG. 9



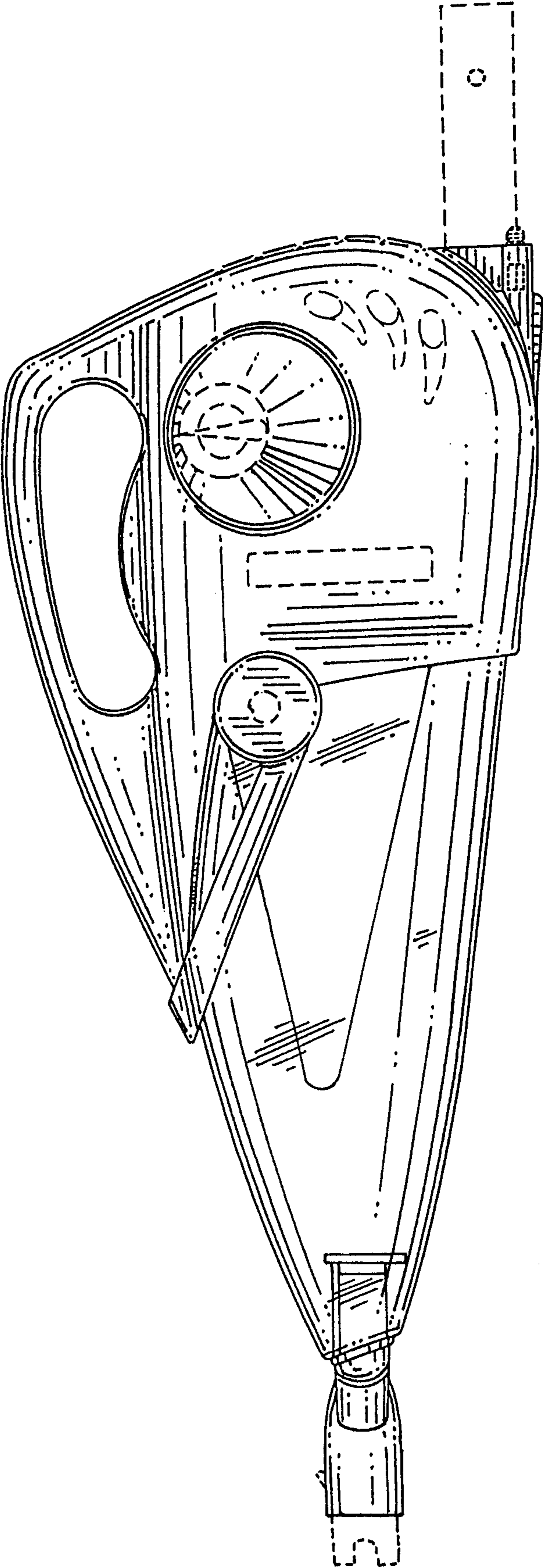

FIG. 10

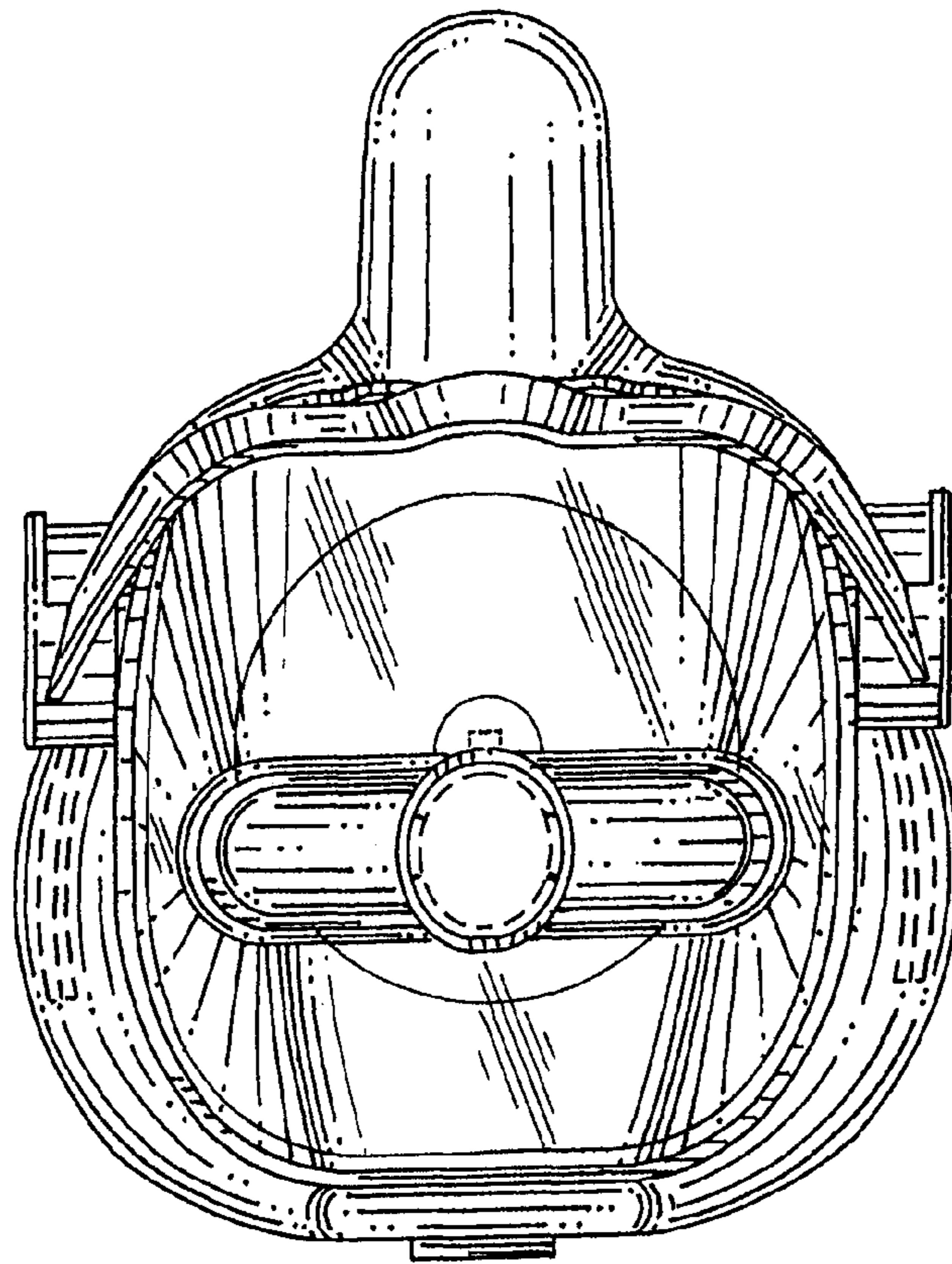
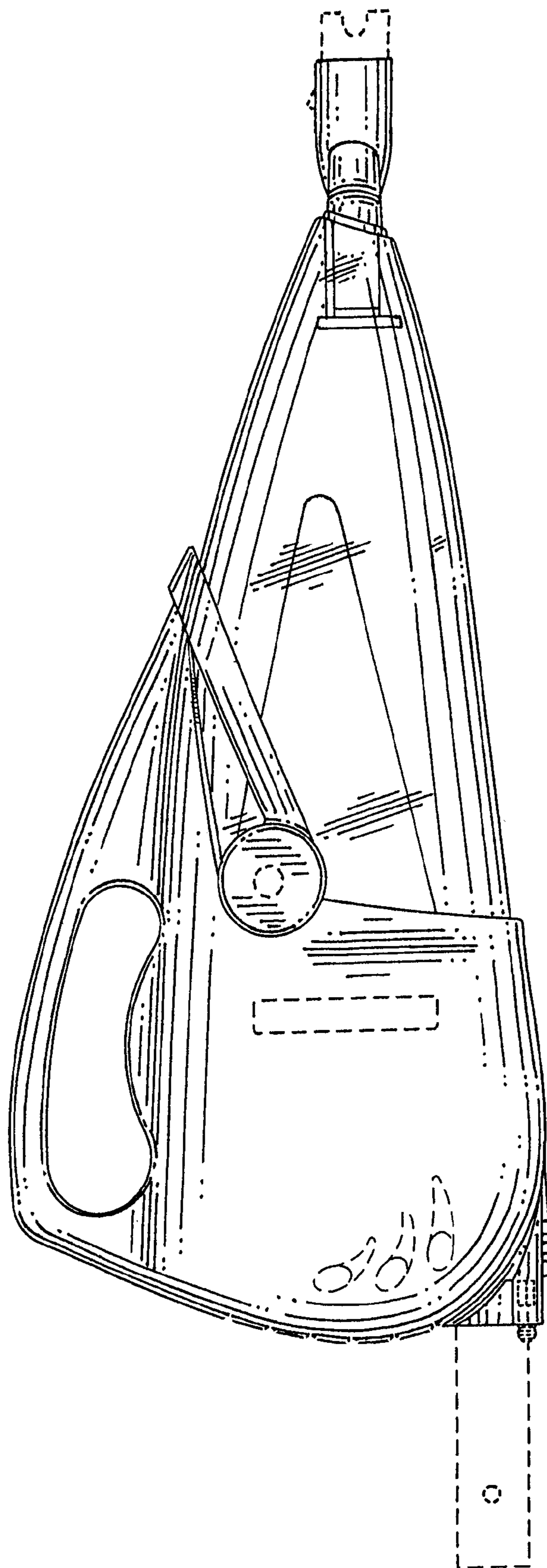

FIG. 11

FIG. 12



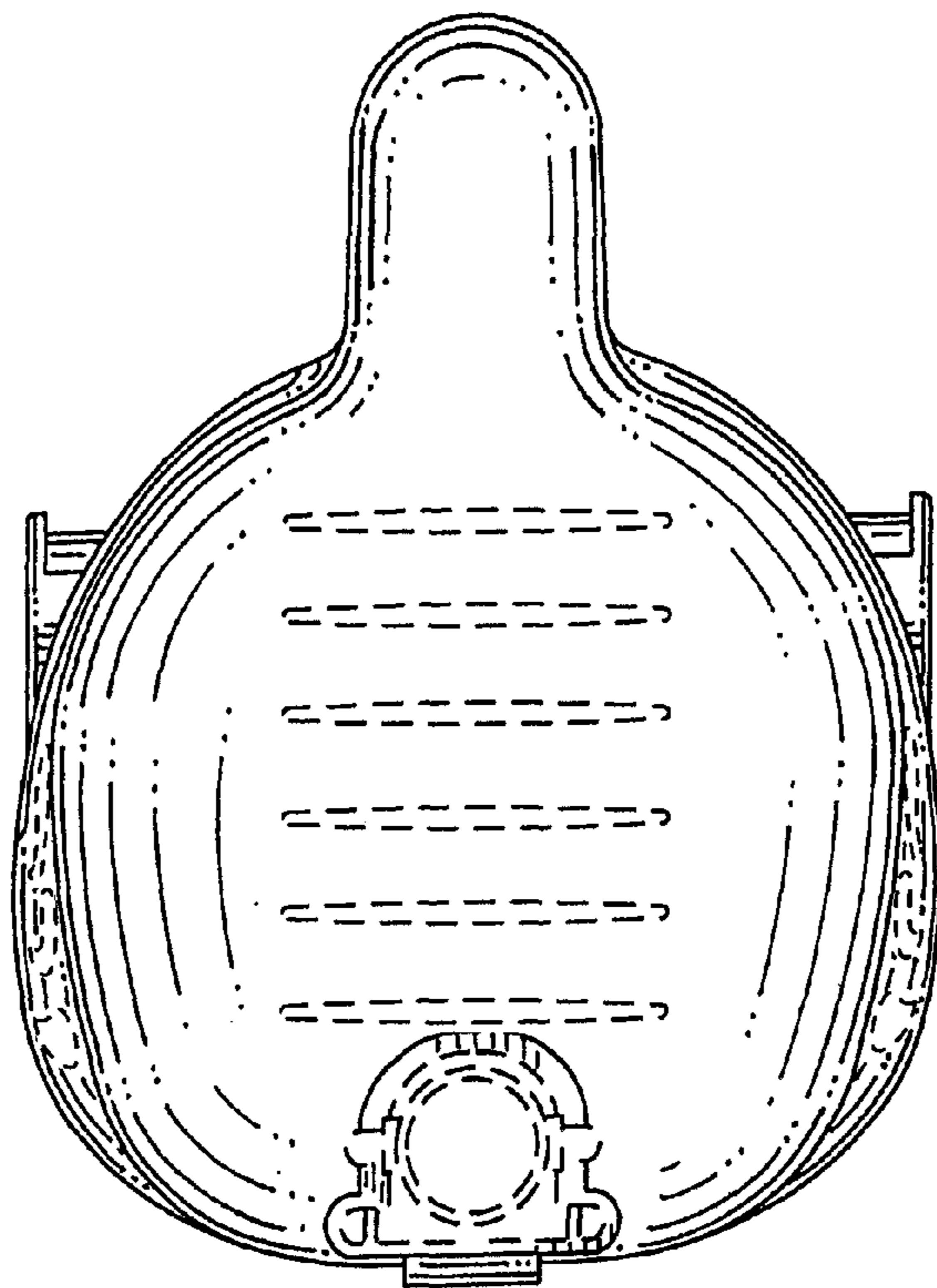

FIG. 13

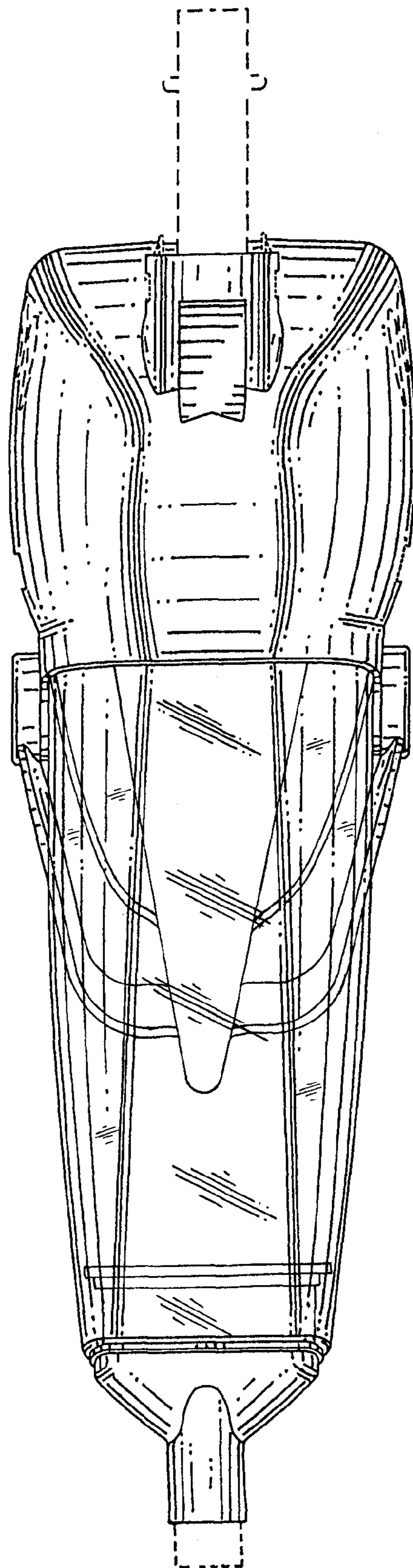

FIG. 14