



US00D720020S

(12) **United States Design Patent**
Chen

(10) **Patent No.:** **US D720,020 S**

(45) **Date of Patent:** **** Dec. 23, 2014**

(54) **TOY PULL HANDLE CLAW**

(71) Applicant: **Shaoyun Chen**, Shantou (CN)

(72) Inventor: **Shaoyun Chen**, Shantou (CN)

(**) Term: **14 Years**

(21) Appl. No.: **29/444,262**

(22) Filed: **Jan. 29, 2013**

(51) **LOC (10) Cl.** **21-01**

(52) **U.S. Cl.**
USPC **D21/532**

(58) **Field of Classification Search**
USPC D21/468, 472, 474, 475, 523, 532, 537,
D21/601; D8/7, 10; D30/162; D7/683, 684,
D7/685, 686, 687, 691, 692; D10/46.2;
414/694; 294/3, 8.5, 28, 99.1, 99.2,
294/118, 119
See application file for complete search history.

(56) **References Cited**

U.S. PATENT DOCUMENTS

4,005,897	A *	2/1977	Smith	294/115
4,248,468	A *	2/1981	Hastings	294/1.4
D261,540	S *	10/1981	Appel et al.	D21/472
D268,939	S *	5/1983	Appel et al.	D21/532
D277,203	S *	1/1985	Paczko	D21/532
D281,108	S *	10/1985	Wilson	D30/162

D288,455	S *	2/1987	Blumenthal	D21/472
4,854,626	A *	8/1989	Duke	294/104
D356,349	S *	3/1995	Kino	D21/532
D368,003	S *	3/1996	Simon	D8/4
5,503,442	A *	4/1996	Lee	294/1.4
D381,816	S *	8/1997	Segarra et al.	D6/328
D477,189	S *	7/2003	Bull et al.	D7/686
D591,115	S *	4/2009	Repac	D7/693
D604,913	S *	11/2009	Boghozian	D30/162

* cited by examiner

Primary Examiner — George D Kirschbaum

Assistant Examiner — Jennifer Watkins

(74) *Attorney, Agent, or Firm* — LaMorte & Associates, P.C.

(57) **CLAIM**

The ornamental design for a toy pull handle claw, as shown and described.

DESCRIPTION

FIG. 1 is a perspective view of the toy pull handle claw;
FIG. 2 is a front view thereof;
FIG. 3 is a rear view thereof;
FIG. 4 is a left side view thereof;
FIG. 5 is a right side view thereof;
FIG. 6 is a top view thereof; and,
FIG. 7 is a bottom view thereof.

The broken line showing of a toy pull handle claw is for the purpose of illustrating portions of the article that form no part of the claimed design.

1 Claim, 6 Drawing Sheets

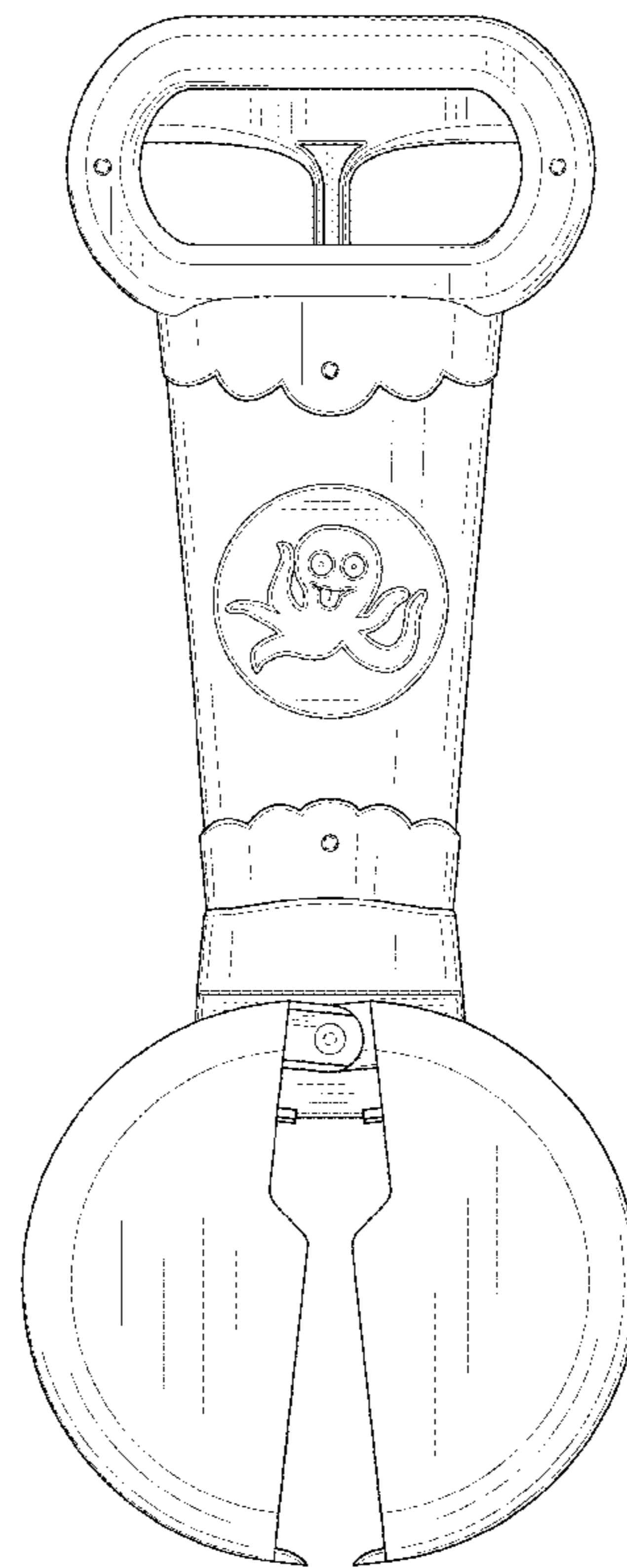
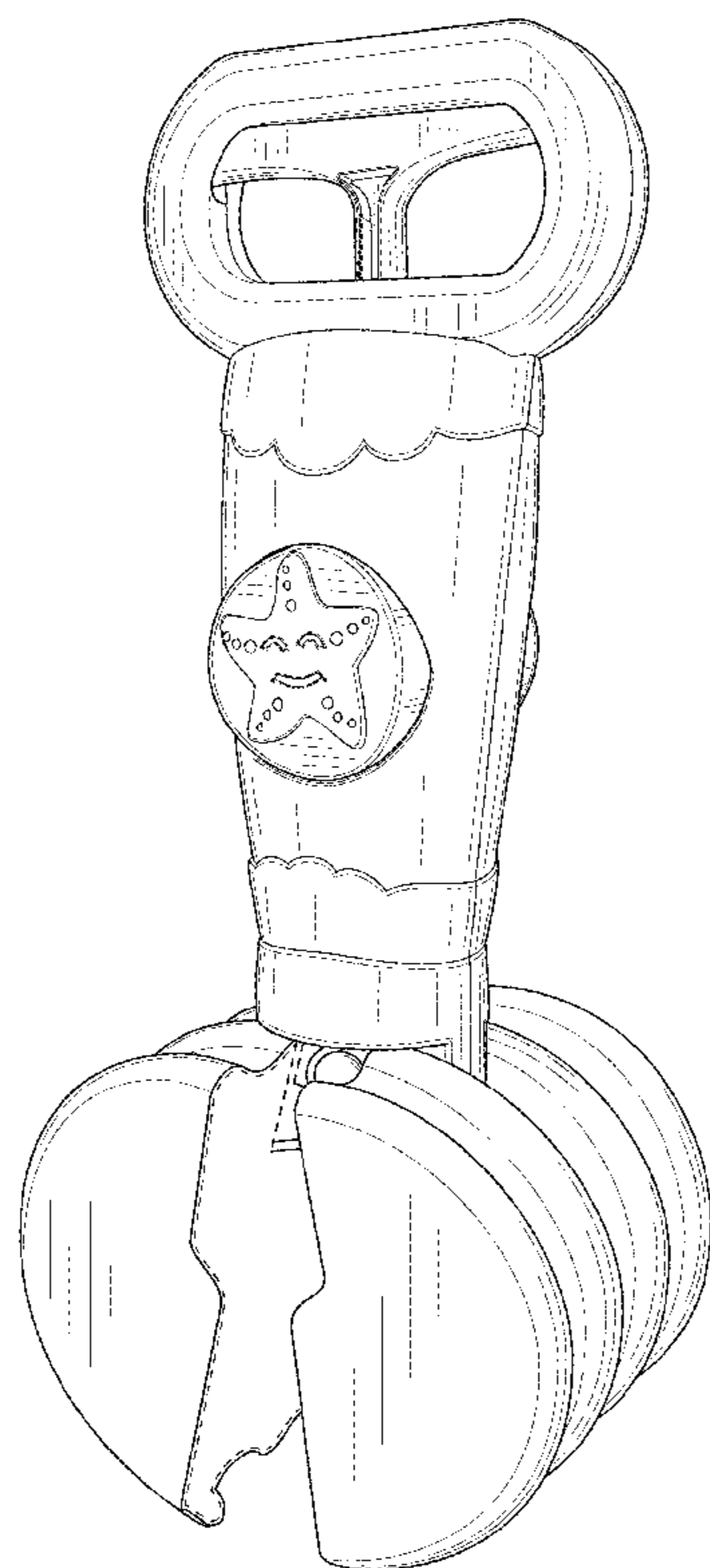

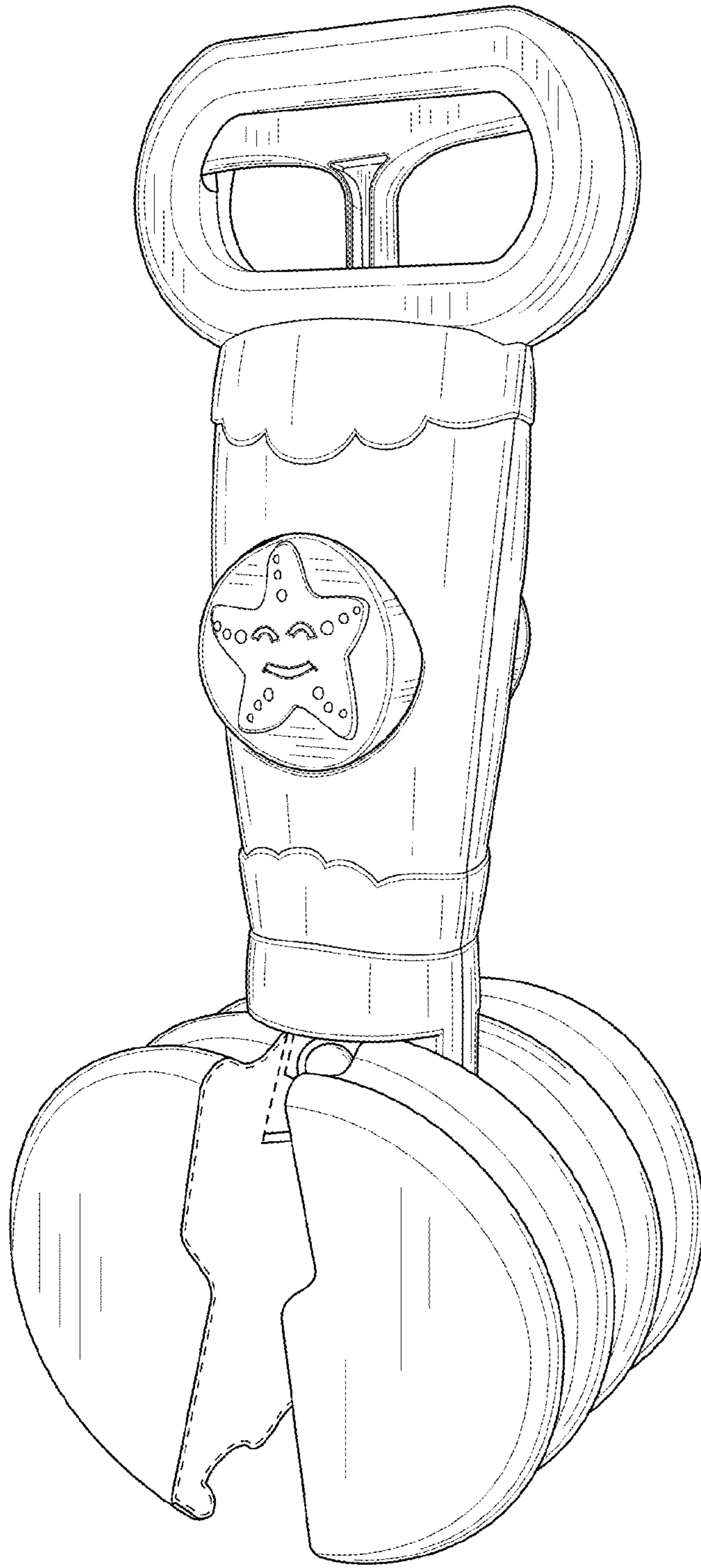

FIG. 1

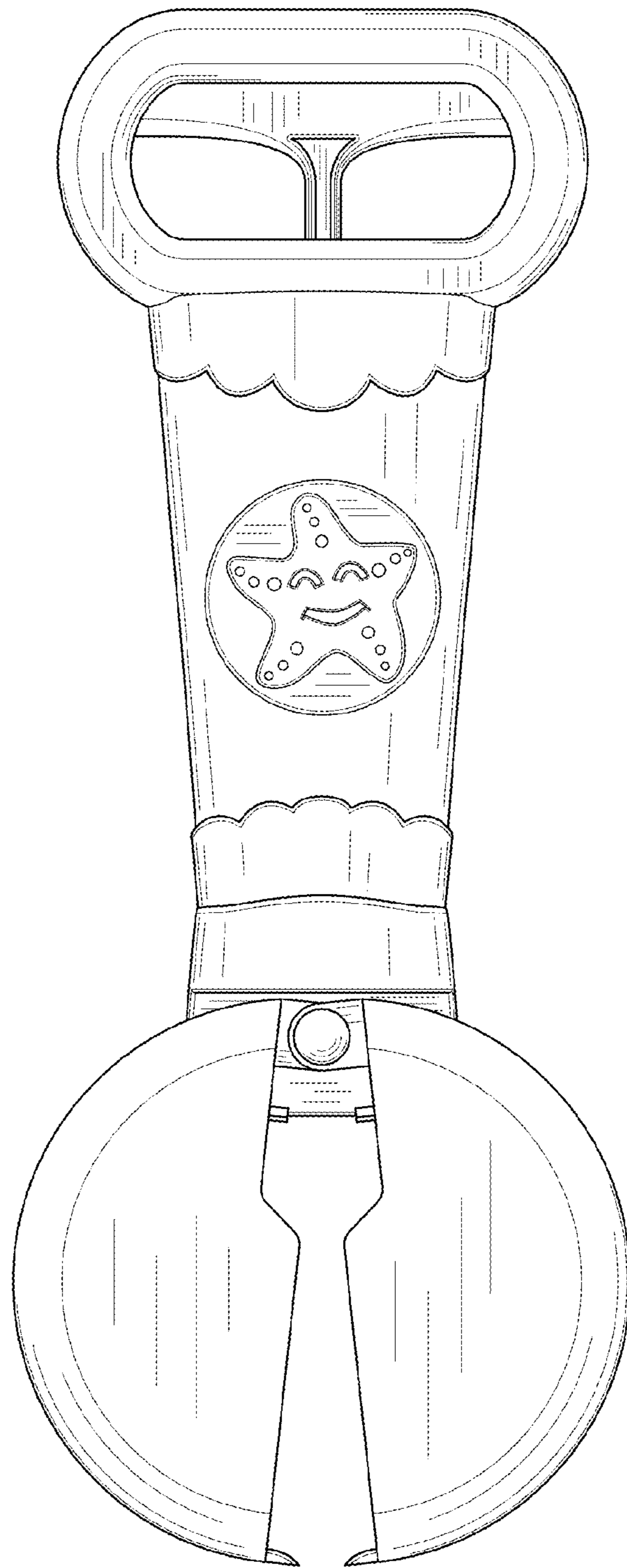

FIG. 2

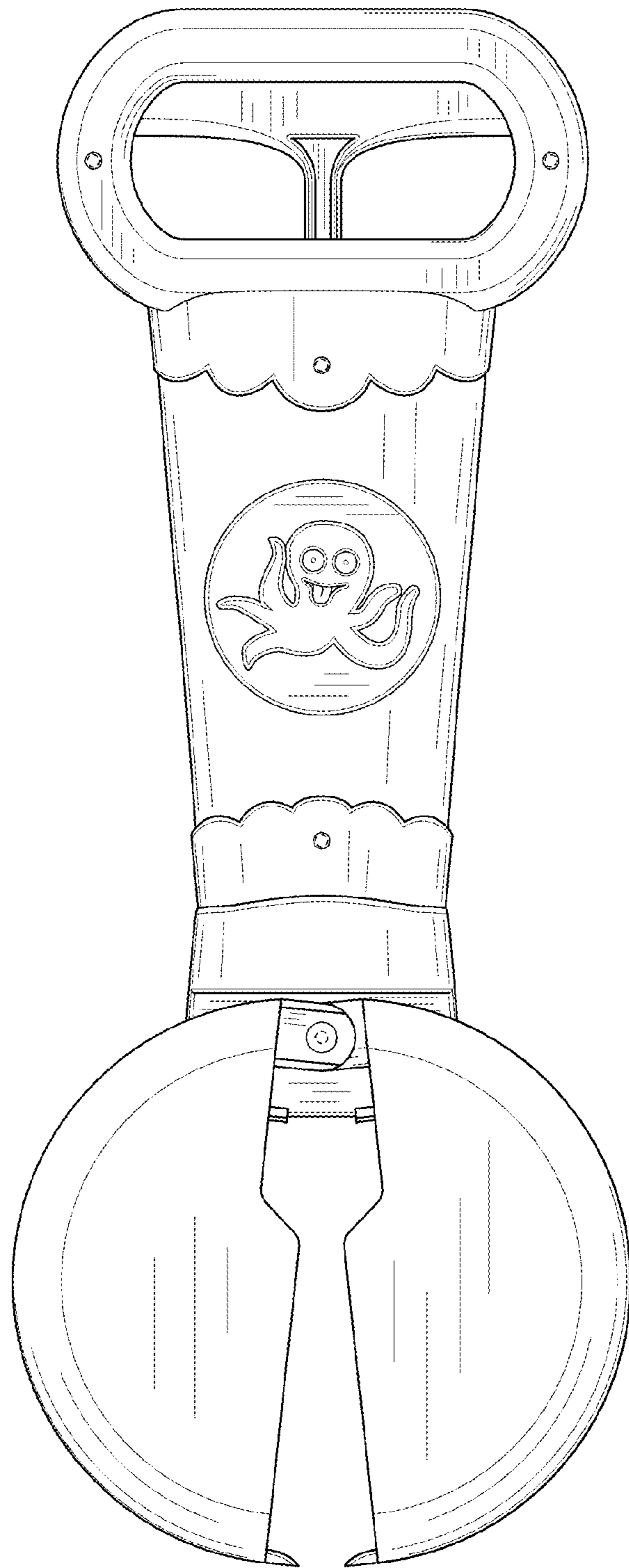

FIG. 3

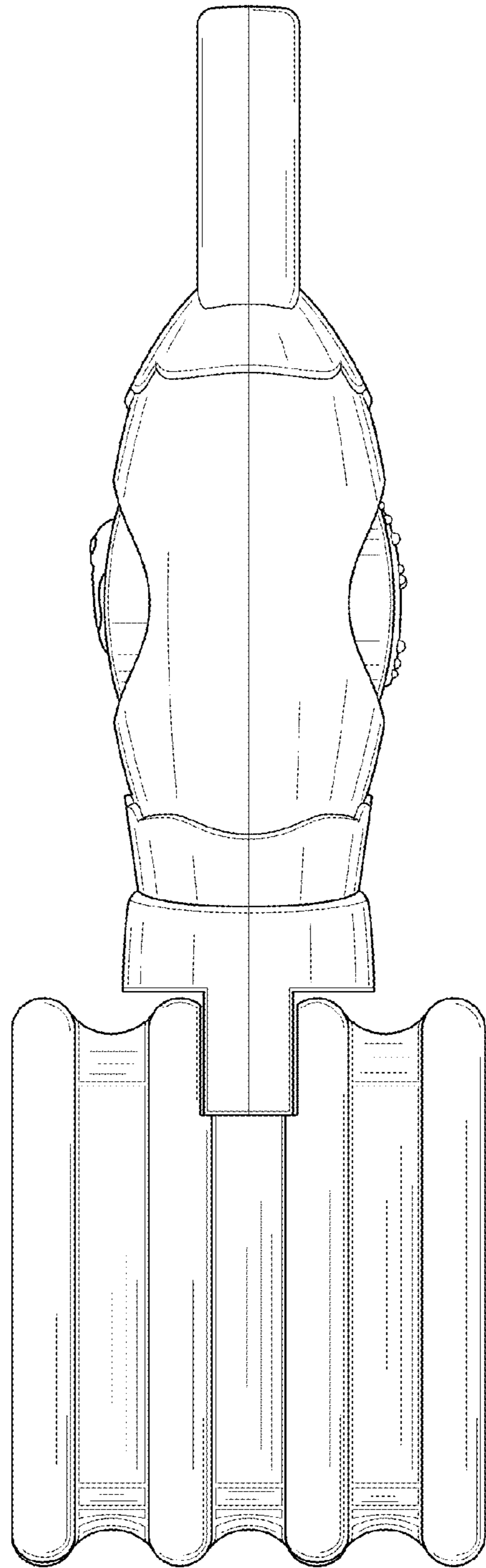

FIG. 4

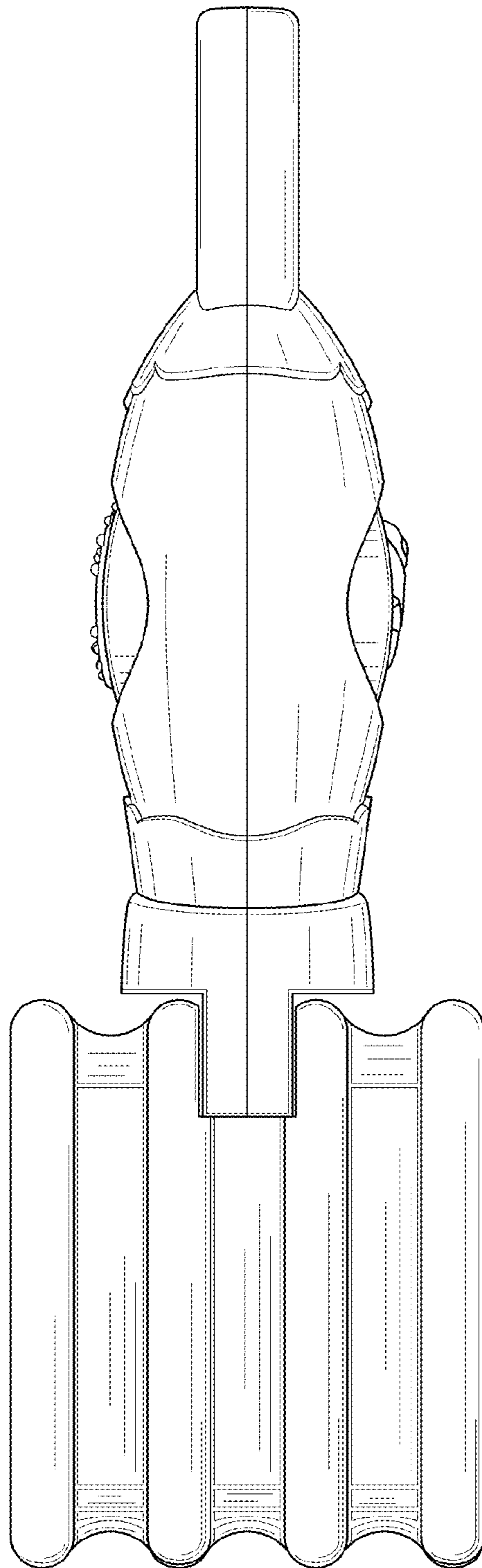

FIG. 5

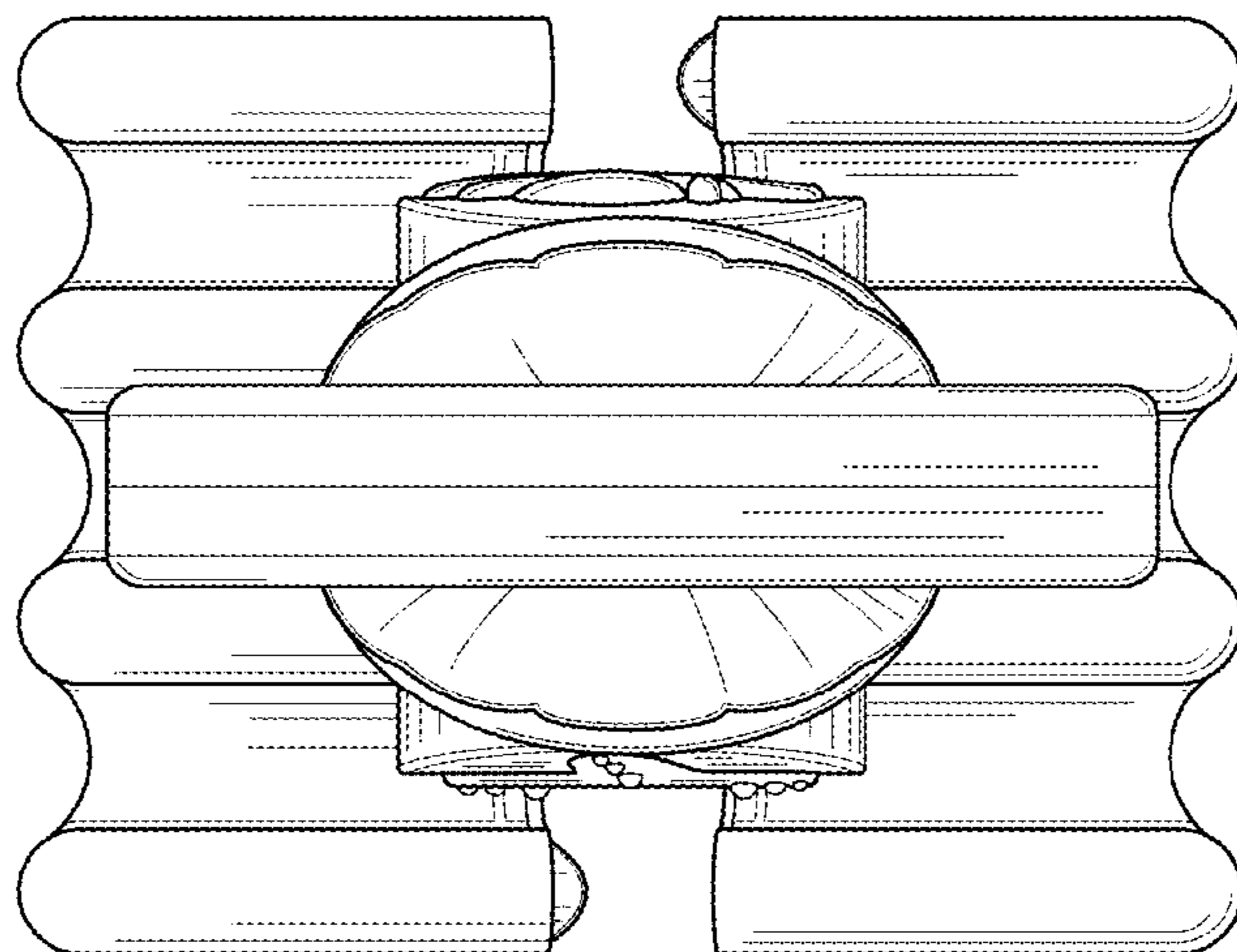

FIG. 6

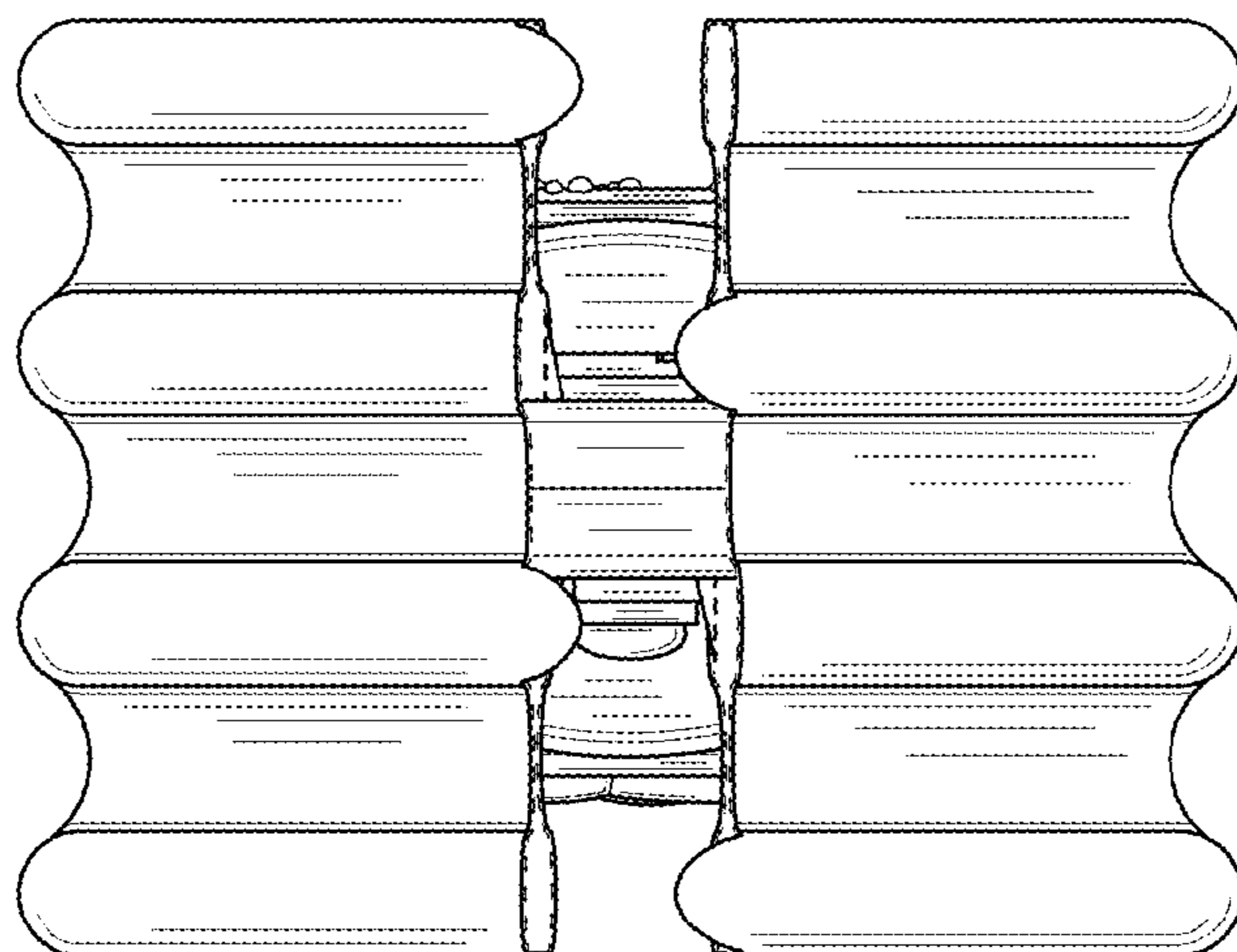

FIG. 7