



US00D719913S

(12) **United States Design Patent**  
**Bies**

(10) **Patent No.:** **US D719,913 S**

(45) **Date of Patent:** **\*\* Dec. 23, 2014**

(54) **ELECTRICAL CONNECTOR**

(75) Inventor: **Henryk Bies**, Sondershausen (DE)

(73) Assignee: **Wago Verwaltungsgesellschaft mbH**,  
Minden (DE)

(\*\*) Term: **14 Years**

(21) Appl. No.: **29/418,952**

(22) Filed: **Apr. 24, 2012**

(51) **LOC (10) Cl.** ..... **13-03**

(52) **U.S. Cl.**  
USPC ..... **D13/133**

(58) **Field of Classification Search**  
USPC ..... D13/133, 146, 147, 154; 439/188, 278,  
439/374, 378, 380, 527, 533, 607.01,  
439/607.04, 607.05, 607.17, 607.25,  
439/607.34, 607.41, 607.53, 668, 540.1,  
439/541.5, 660, 892, 894, 939

See application file for complete search history.

(56) **References Cited**

**U.S. PATENT DOCUMENTS**

D419,133 S *	1/2000	Yoshida et al.	.....	D13/120
D431,528 S *	10/2000	Zhu et al.	.....	D13/133
D467,872 S *	12/2002	Yeh	.....	D13/133
D558,674 S *	1/2008	Lin et al.	.....	D13/133
D558,678 S *	1/2008	Han et al.	.....	D13/154
D577,677 S *	9/2008	Li et al.	.....	D13/133
D578,487 S *	10/2008	Han et al.	.....	D13/154

D616,820 S *	6/2010	Gong et al.	.....	D13/133
D632,251 S *	2/2011	Chen	.....	D13/147
D632,252 S *	2/2011	Guo et al.	.....	D13/147
D641,320 S *	7/2011	Huang	.....	D13/133
D673,117 S *	12/2012	Gassauer	.....	D13/133
D674,344 S *	1/2013	Bies	.....	D13/133
D693,303 S *	11/2013	Bies	.....	D13/133

\* cited by examiner

*Primary Examiner* — Thomas Johannes

*Assistant Examiner* — Khawaja Anwar

(74) *Attorney, Agent, or Firm* — Renner, Otto, Boisselle & Sklar LLP.

(57) **CLAIM**

The ornamental design for an electrical connector, as shown and described.

**DESCRIPTION**

FIG. 1 is a front view of an electrical connector showing my new design;

FIG. 2 is a bottom view thereof;

FIG. 3 is a right side view thereof;

FIG. 4 is a left side view thereof;

FIG. 5 is a rear view thereof;

FIG. 6 is a top view thereof; and,

FIG. 7 is a perspective view thereof.

The broken line in the drawing view is included to show unclaimed environment only and forms no part of the claimed design.

**1 Claim, 7 Drawing Sheets**

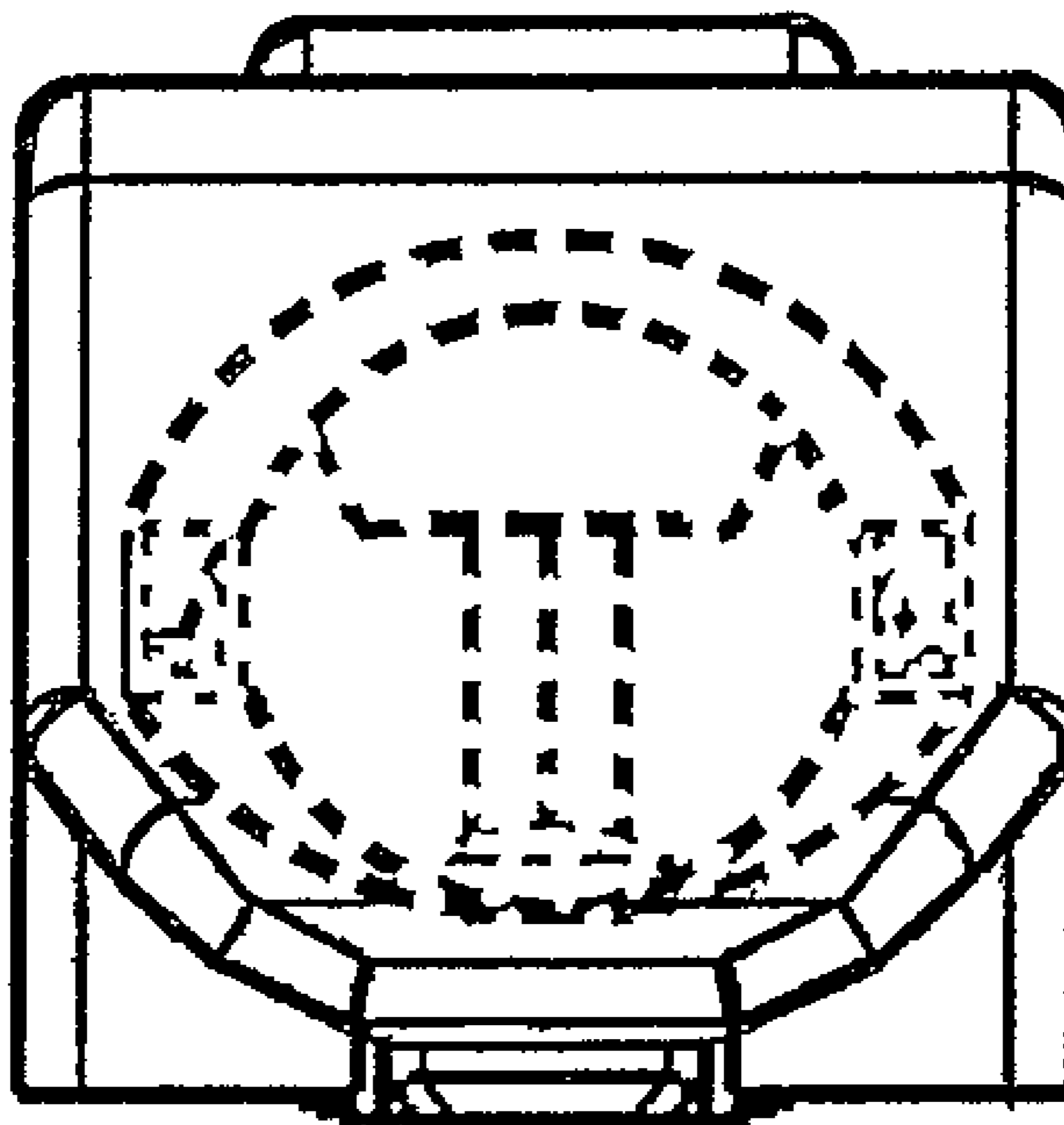

FIGURE 1

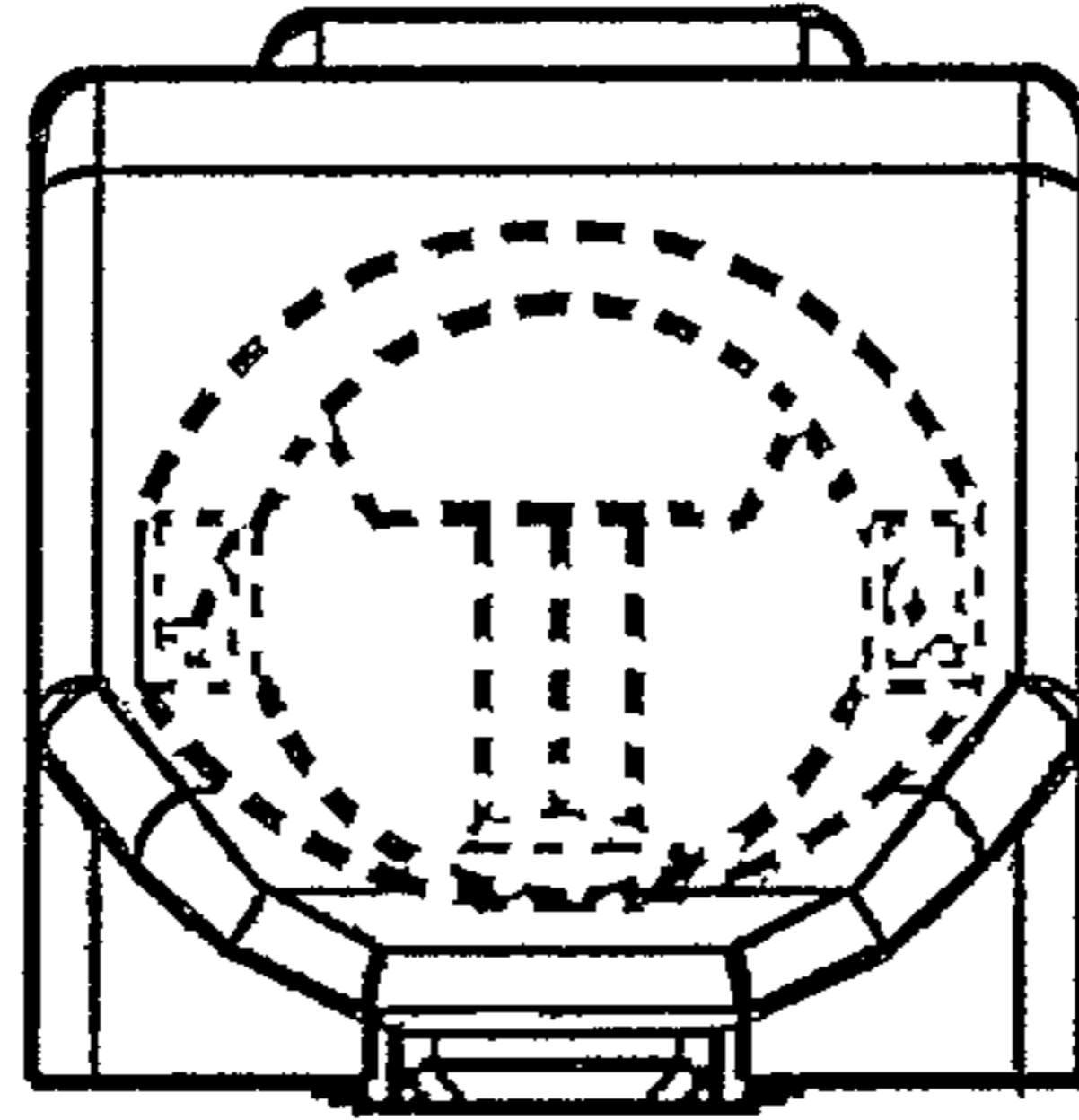

FIGURE 2

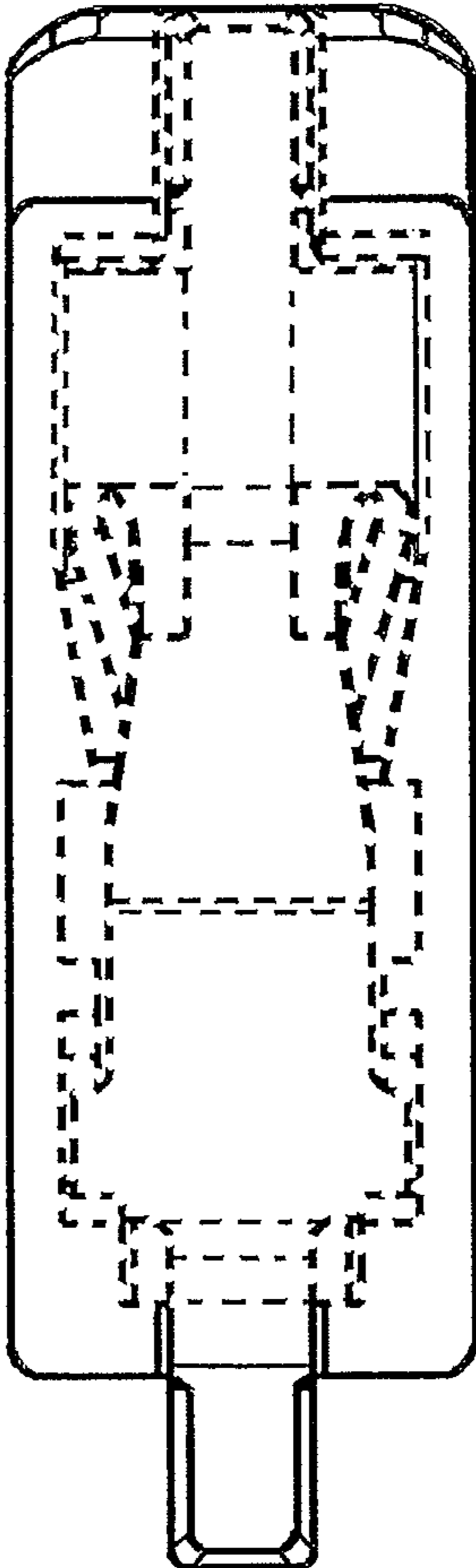

FIGURE 3

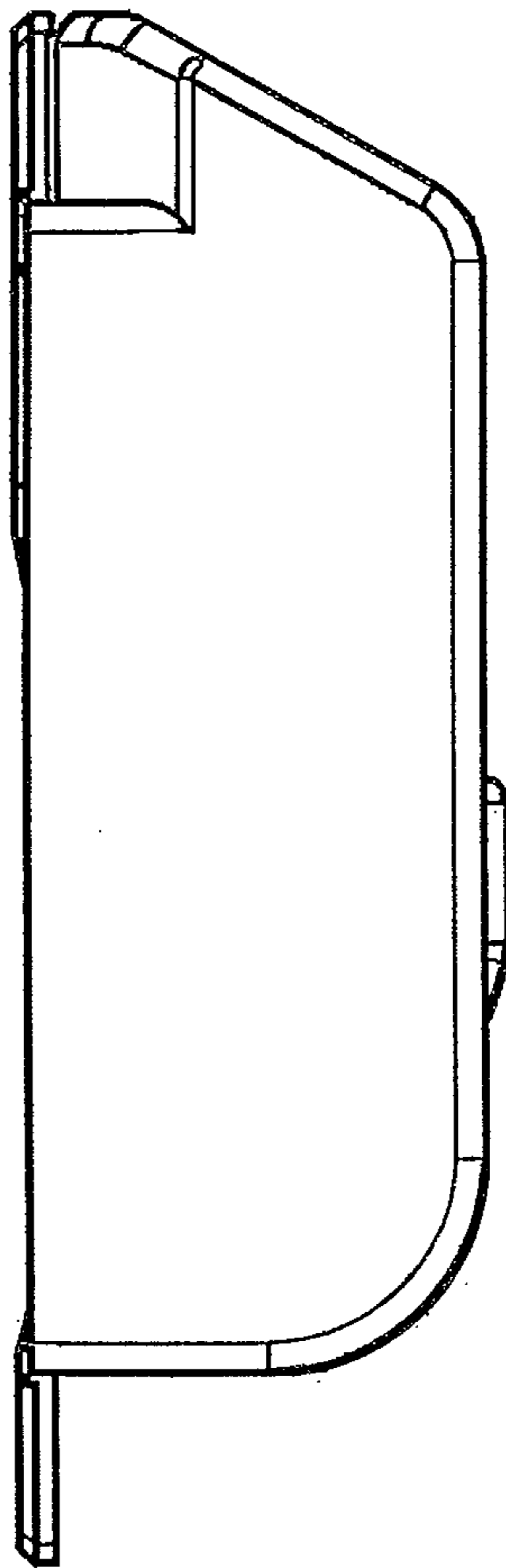
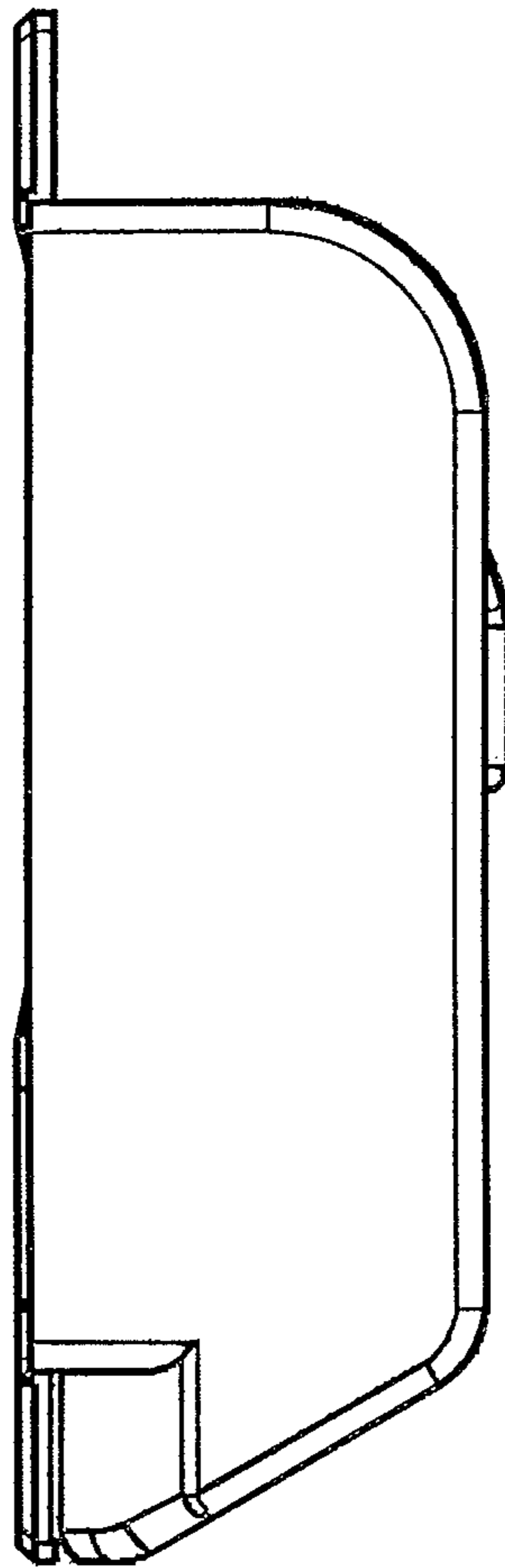

FIGURE 4



**FIGURE 5**

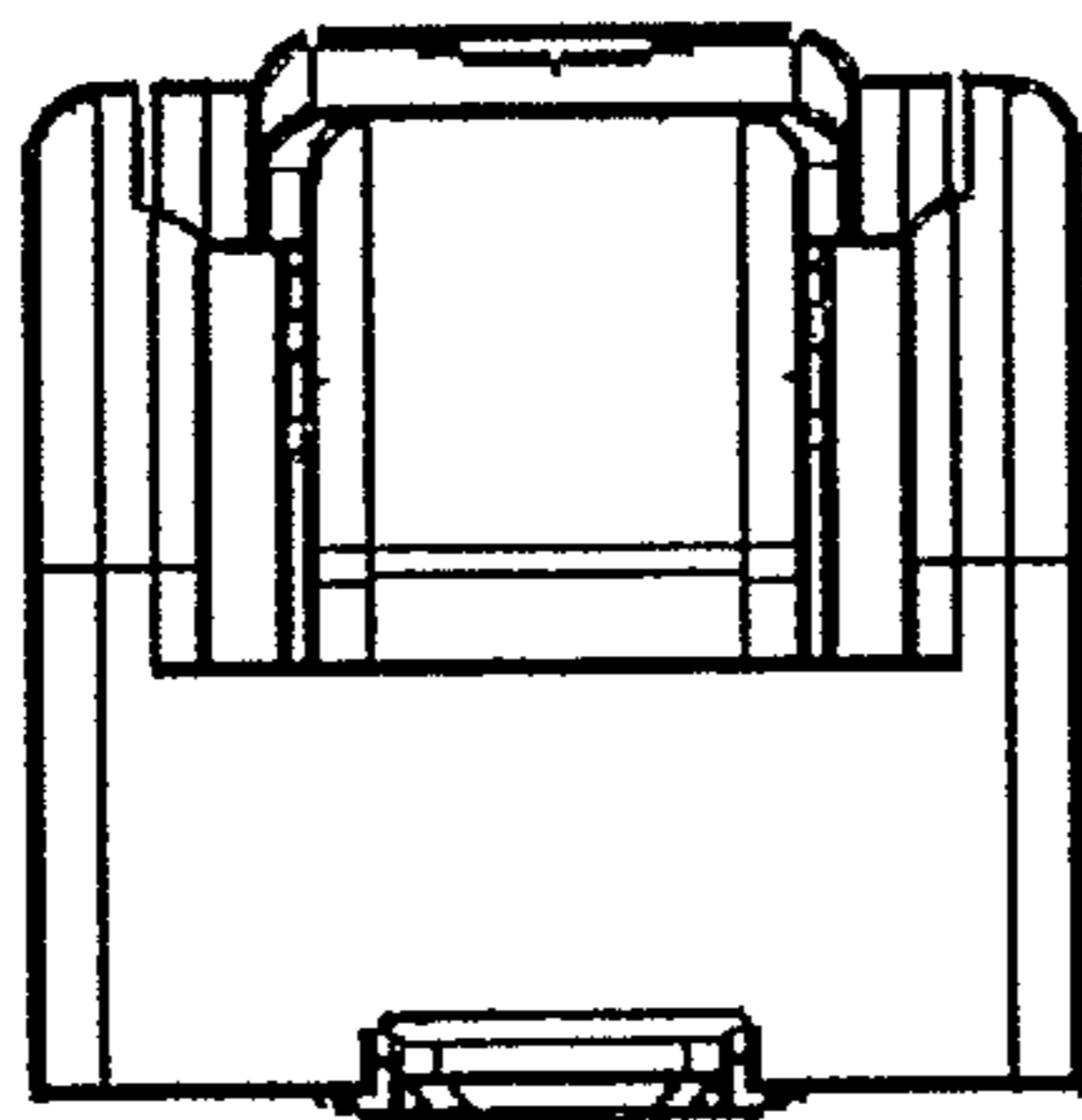

FIGURE 6

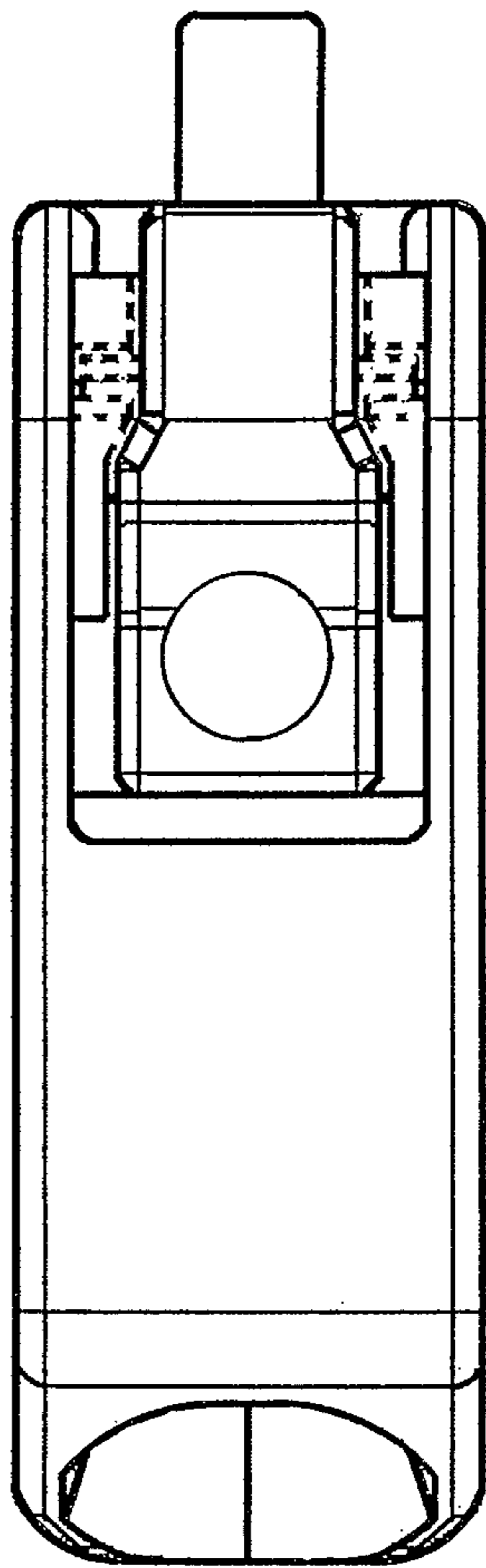

FIGURE 7

