



US00D719894S

(12) **United States Design Patent**
Akita et al.

(10) **Patent No.:** **US D719,894 S**

(45) **Date of Patent:** **** Dec. 23, 2014**

(54) **STEERING HANDLE COVER FOR WATERCRAFT**

(71) Applicant: **Kawasaki Jukogyo Kabushiki Kaisha,**
Hyogo (JP)

(72) Inventors: **Kohei Akita,** Akashi (JP); **Norikazu**
Matsumura, Akashi (JP)

(73) Assignee: **Kawasaki Jukogyo Kabushiki Kaisha,**
Hyogo (JP)

(**) Term: **14 Years**

(21) Appl. No.: **29/463,670**

(22) Filed: **Feb. 3, 2014**

(30) **Foreign Application Priority Data**

Aug. 28, 2013 (JP) 2013-019762

(51) **LOC (10) Cl.** **12-06**

(52) **U.S. Cl.**
USPC **D12/307; D12/317**

(58) **Field of Classification Search**
USPC D12/6-11, 177, 300-318; 114/55.5,
114/55.51-55.58, 144 R, 151, 154, 345;
440/1, 40

See application file for complete search history.

(56) **References Cited**

U.S. PATENT DOCUMENTS

D516,006	S	*	2/2006	Bucaccio et al.	D12/307
7,017,507	B2	*	3/2006	Hattori et al.	114/144 R
D608,719	S	*	1/2010	Cote et al.	D12/307
7,699,010	B2	*	4/2010	Spade et al.	114/55.57
D637,544	S	*	5/2011	Cote et al.	D12/307
D637,545	S	*	5/2011	Cote et al.	D12/317
2005/0235894	A1	*	10/2005	Hattori et al.	114/144 R
2006/0037524	A1	*	2/2006	Kamio	114/144 R

* cited by examiner

Primary Examiner — Cynthia M Chin

(57) **CLAIM**

The ornamental design for a steering handle cover for watercraft, as shown and described.

DESCRIPTION

FIG. 1 is a front elevational view of a steering handle cover for watercraft showing our new design;
FIG. 2 is a rear elevational view thereof;
FIG. 3 is a left side elevational view thereof;
FIG. 4 is a right side elevational view thereof;
FIG. 5 is a top plan view thereof;
FIG. 6 is a bottom plan view thereof;
FIG. 7 is a front left perspective view thereof;
FIG. 8 is a rear left perspective view thereof;
FIG. 9 is a front right perspective view thereof; and,
FIG. 10 is a rear right perspective view thereof.

1 Claim, 5 Drawing Sheets

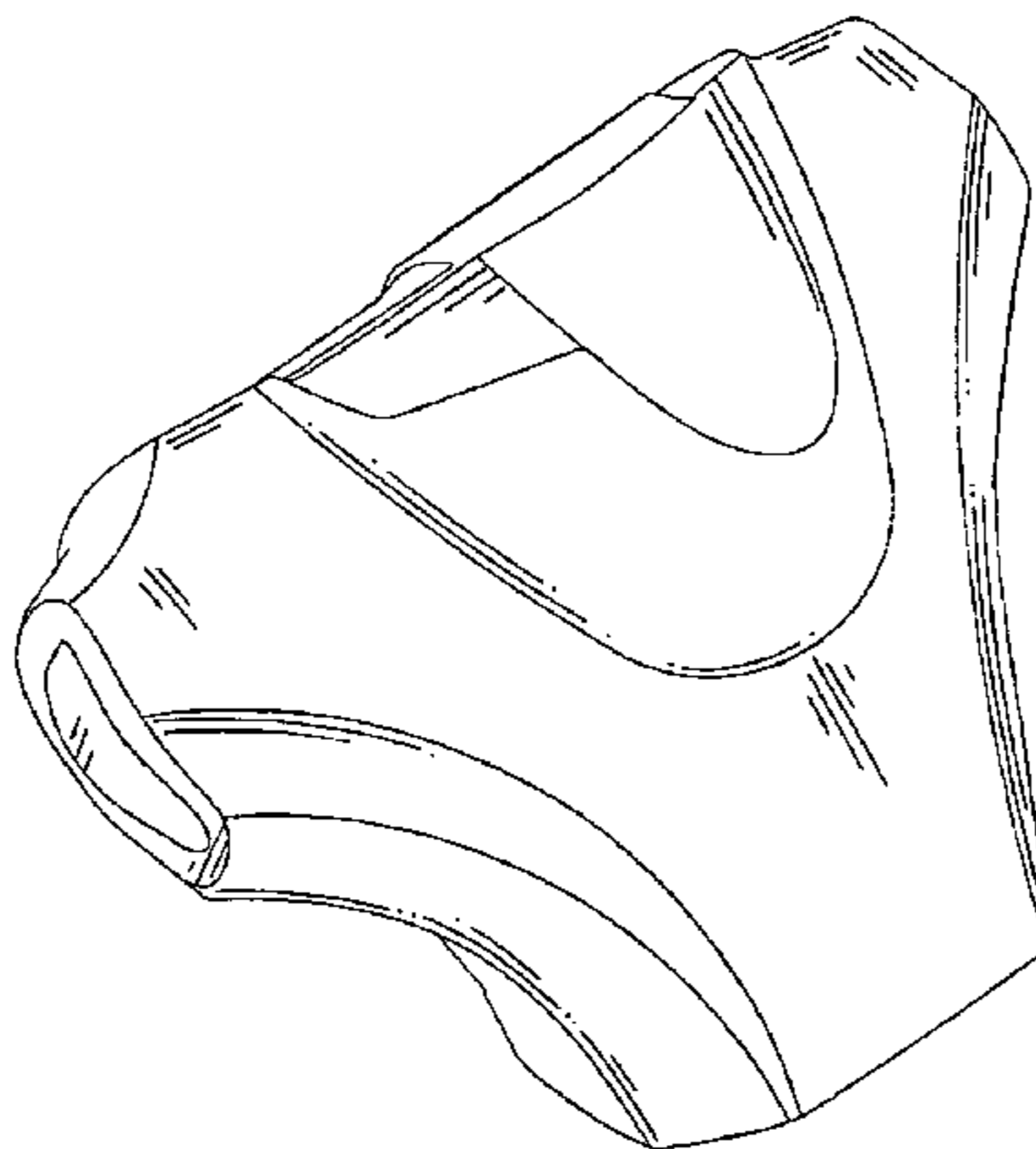
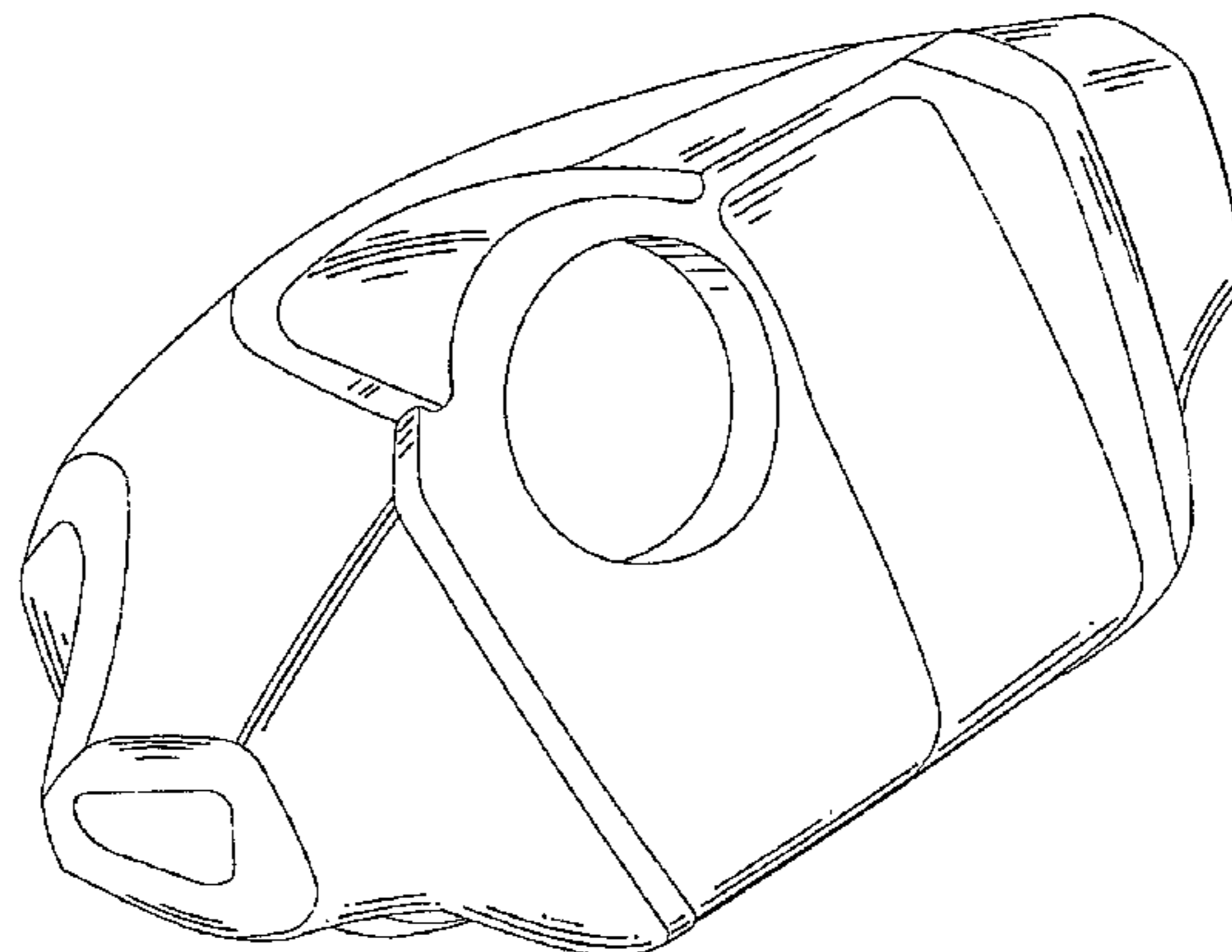

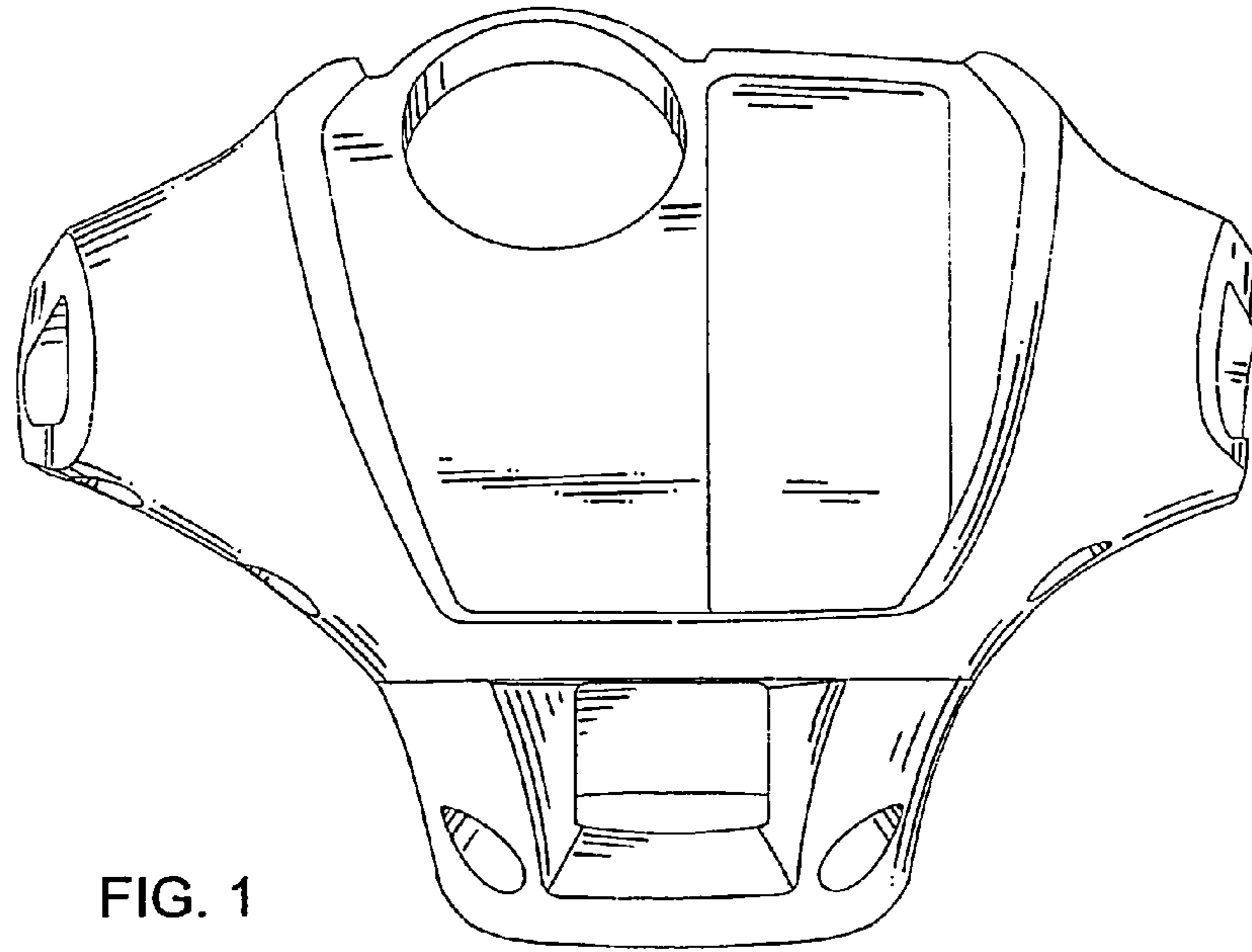

FIG. 1

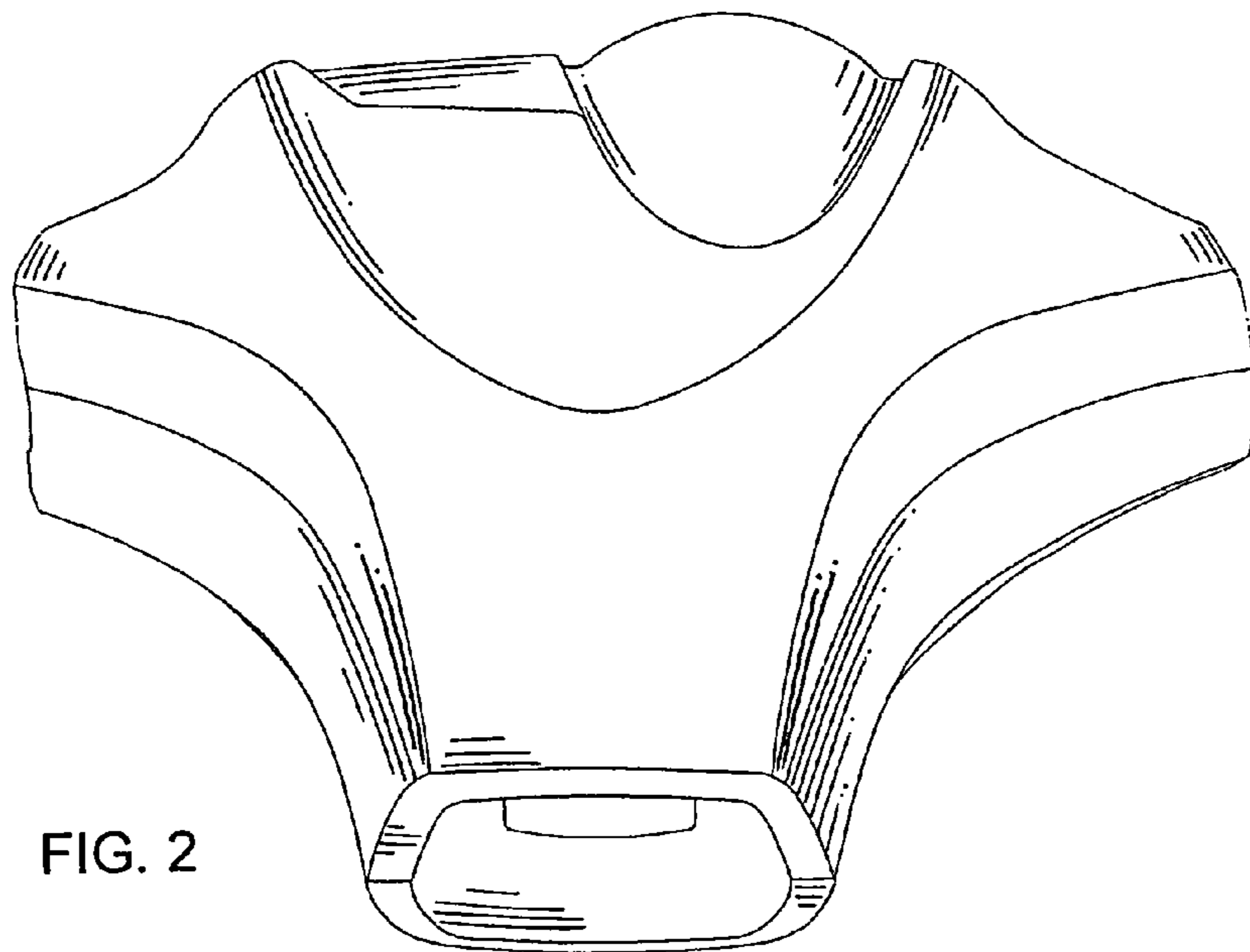

FIG. 2

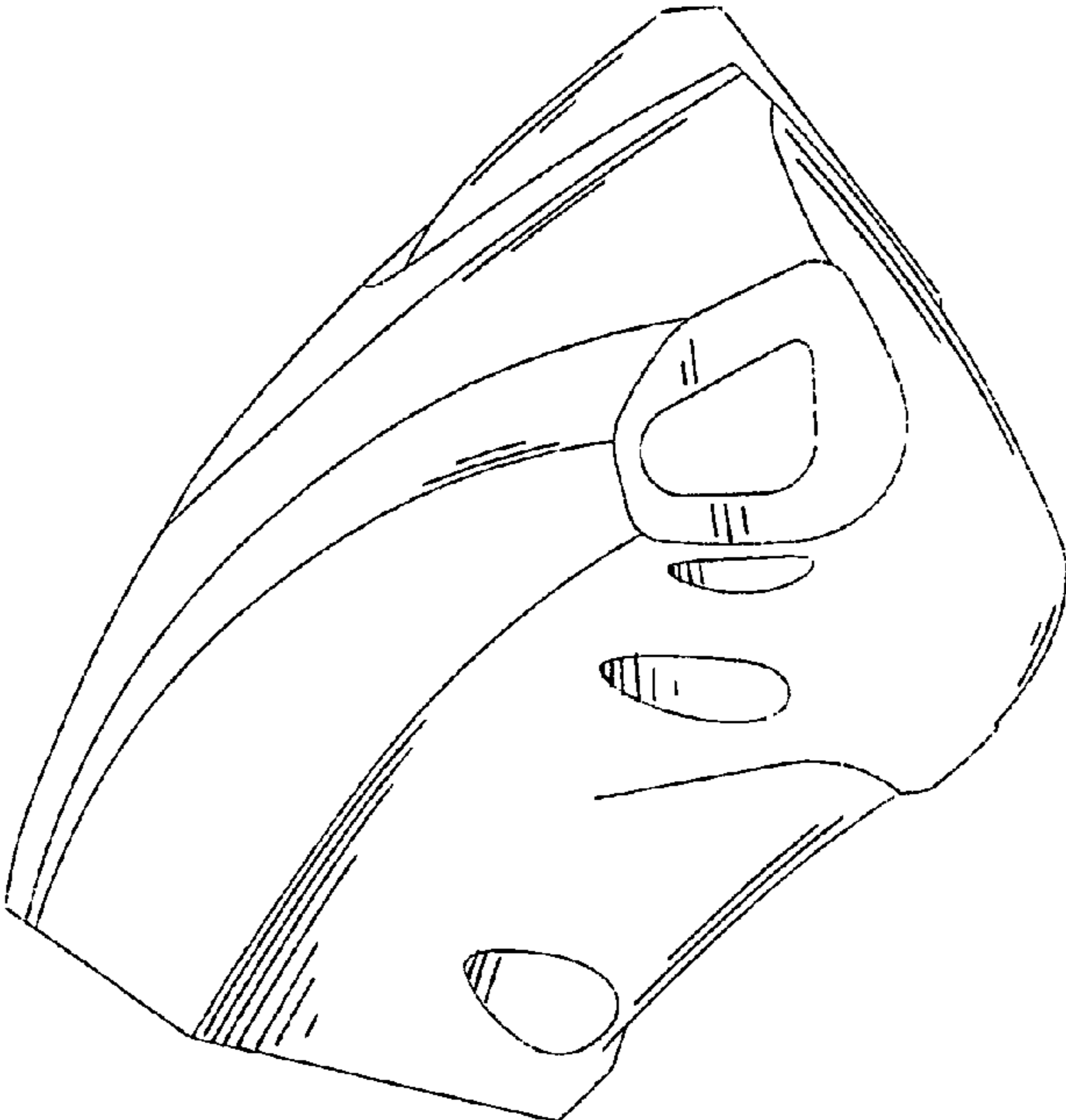

FIG. 3

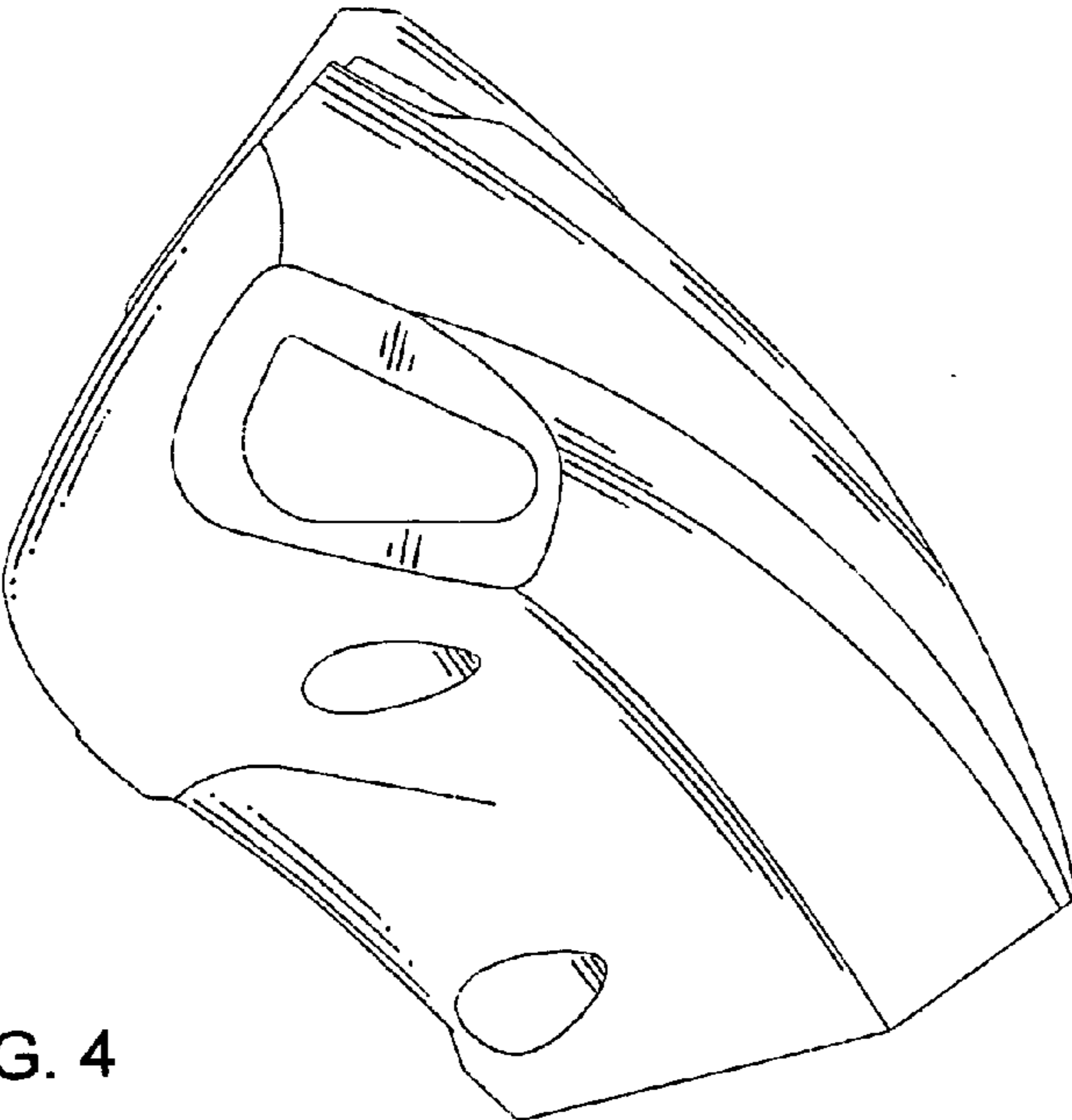

FIG. 4

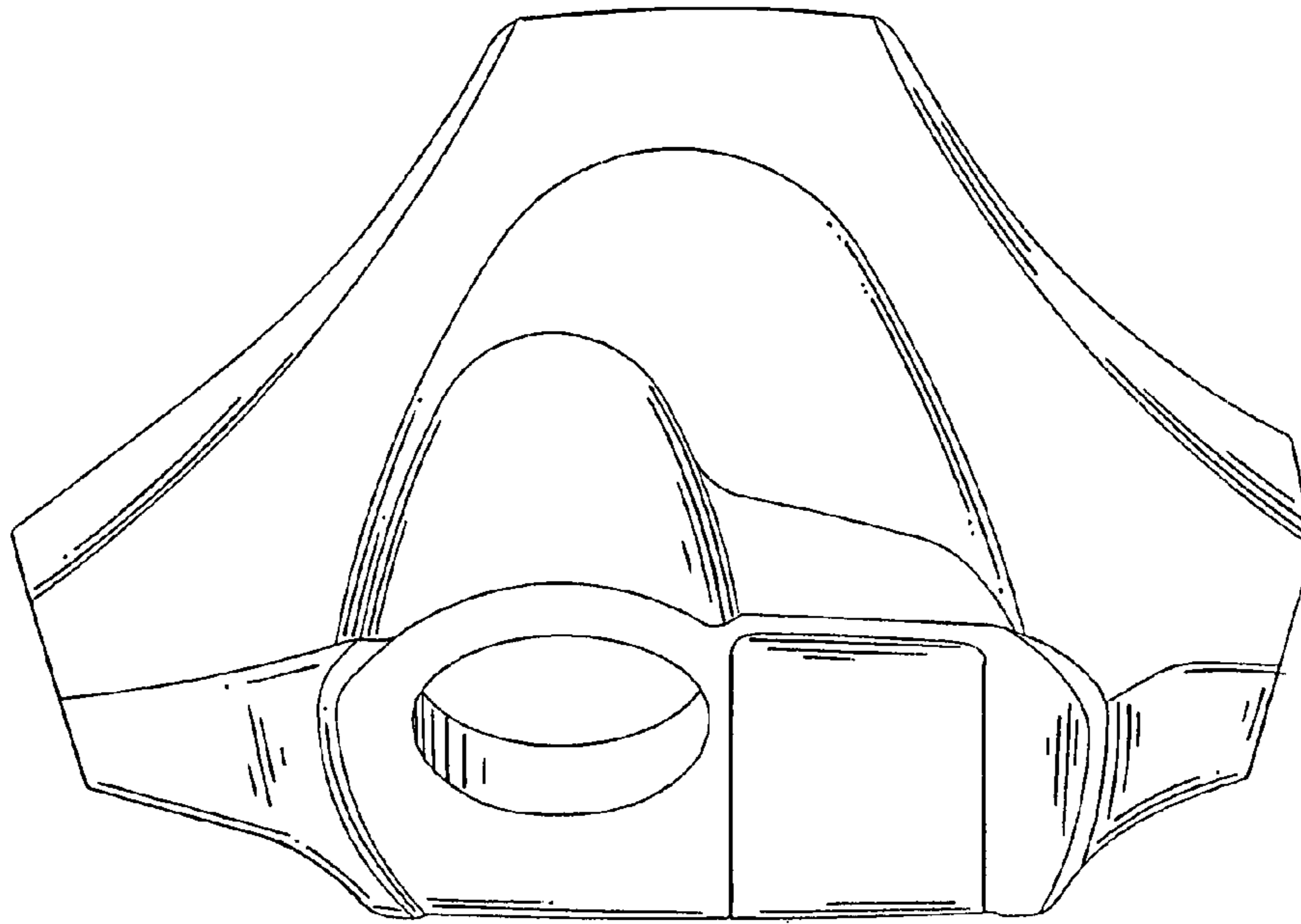

FIG. 5

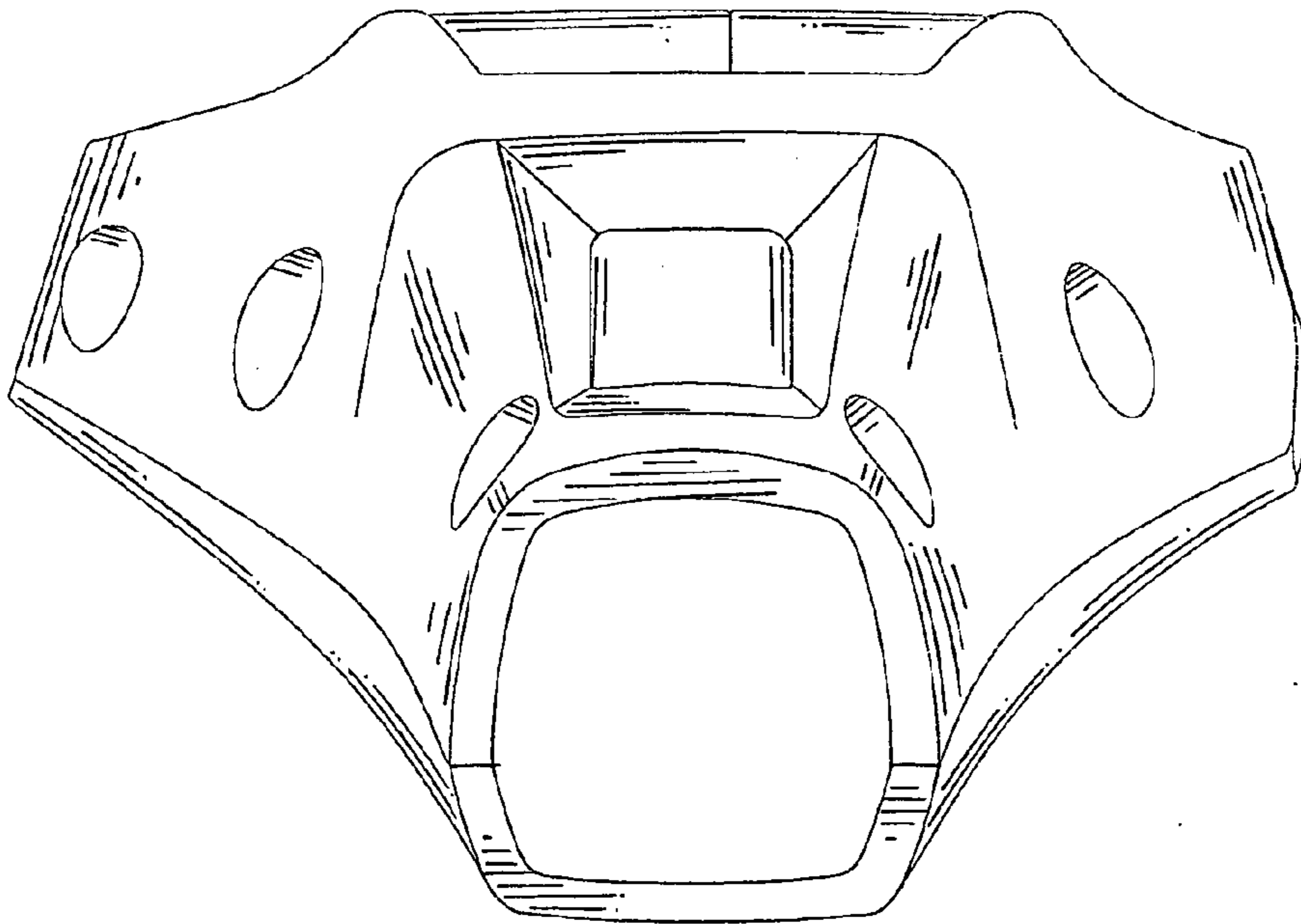

FIG. 6

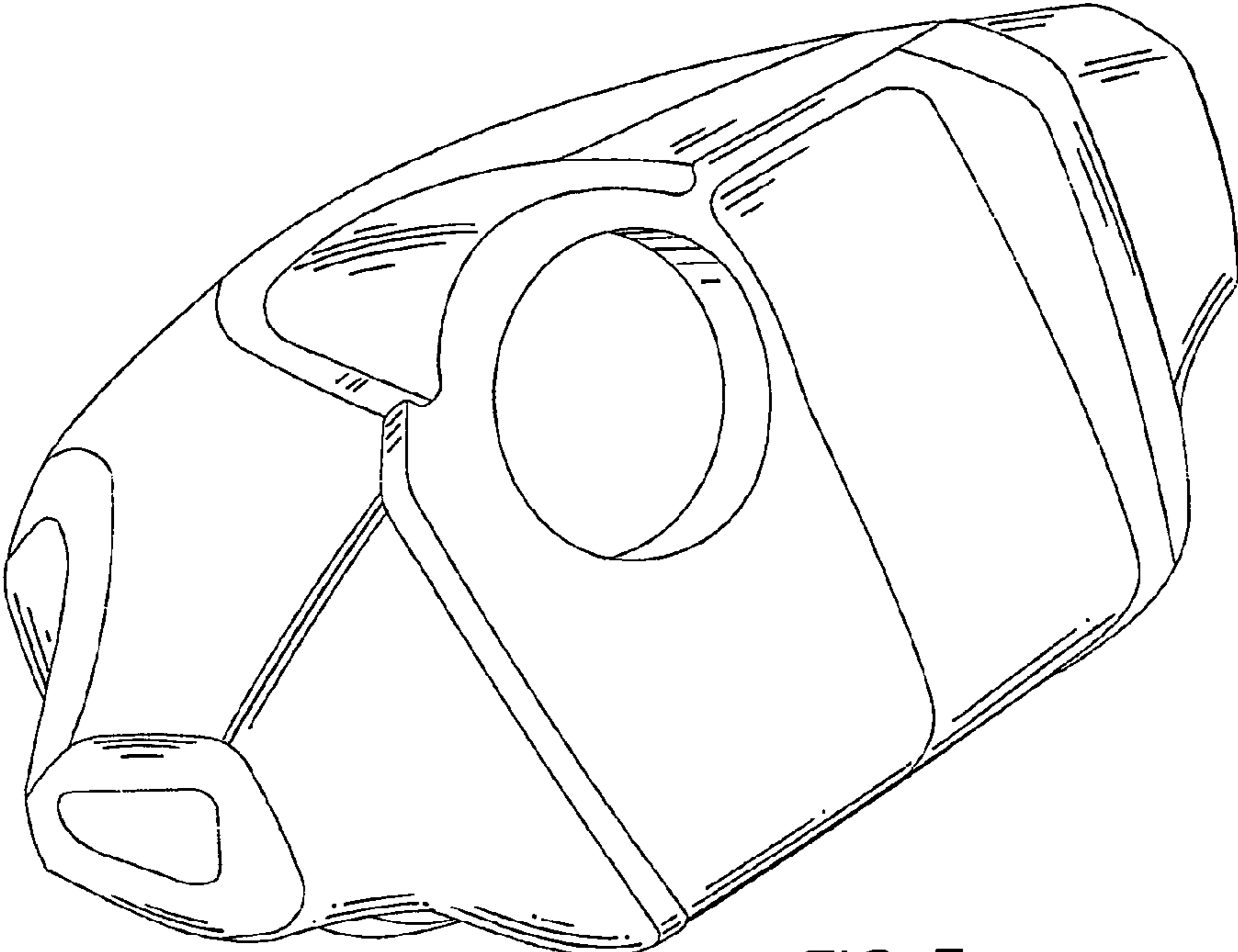

FIG. 7

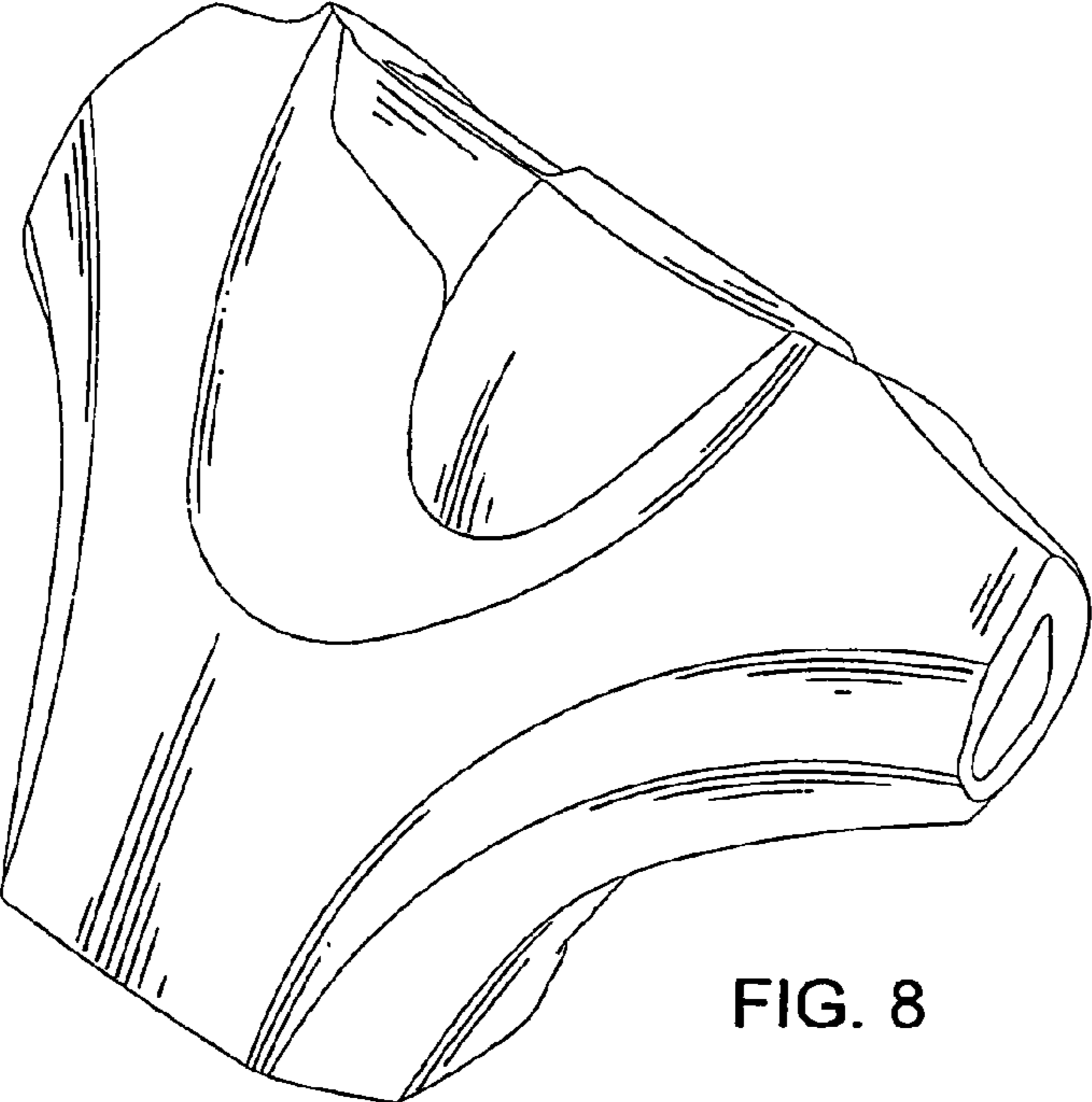

FIG. 8

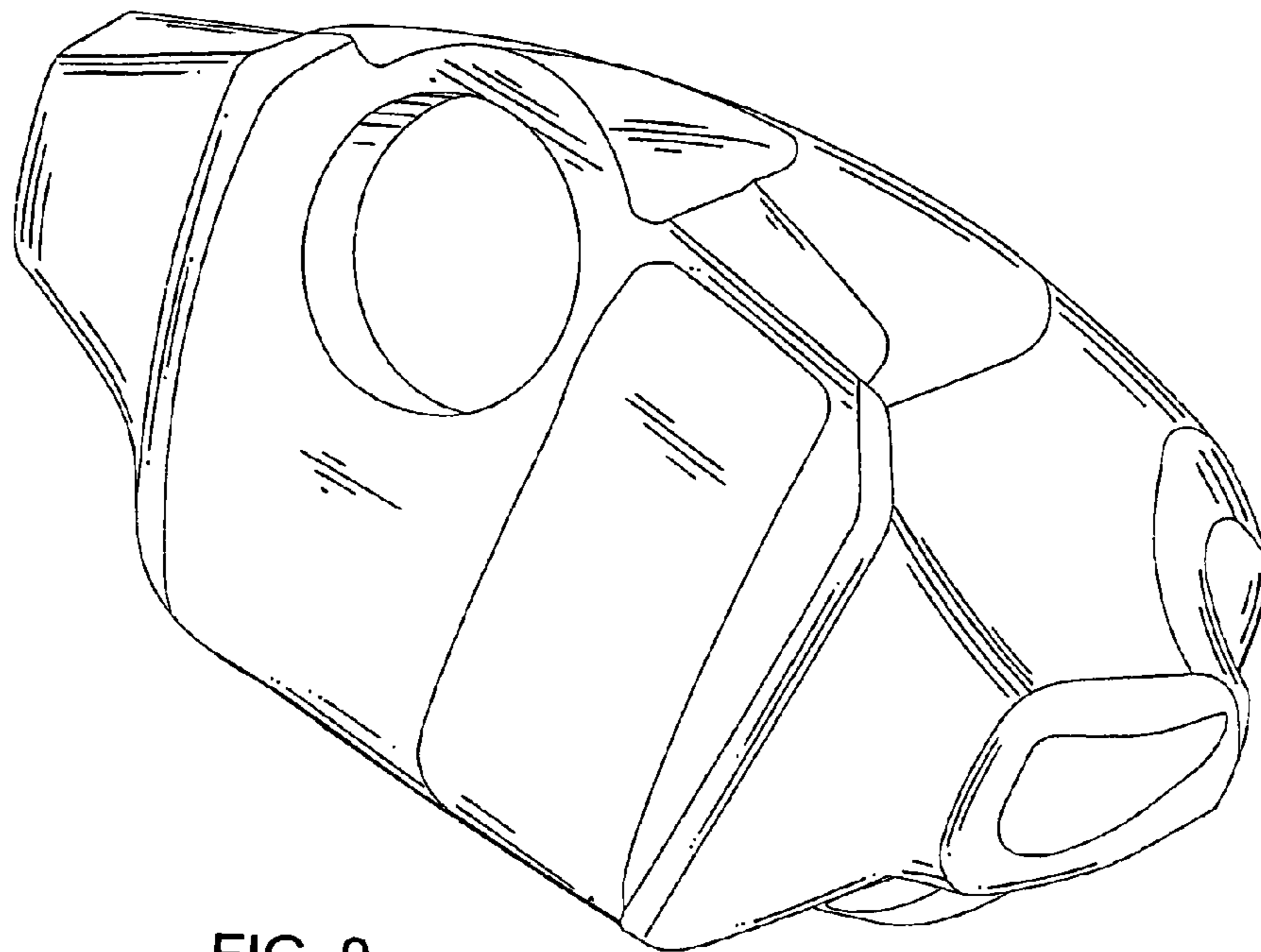

FIG. 9

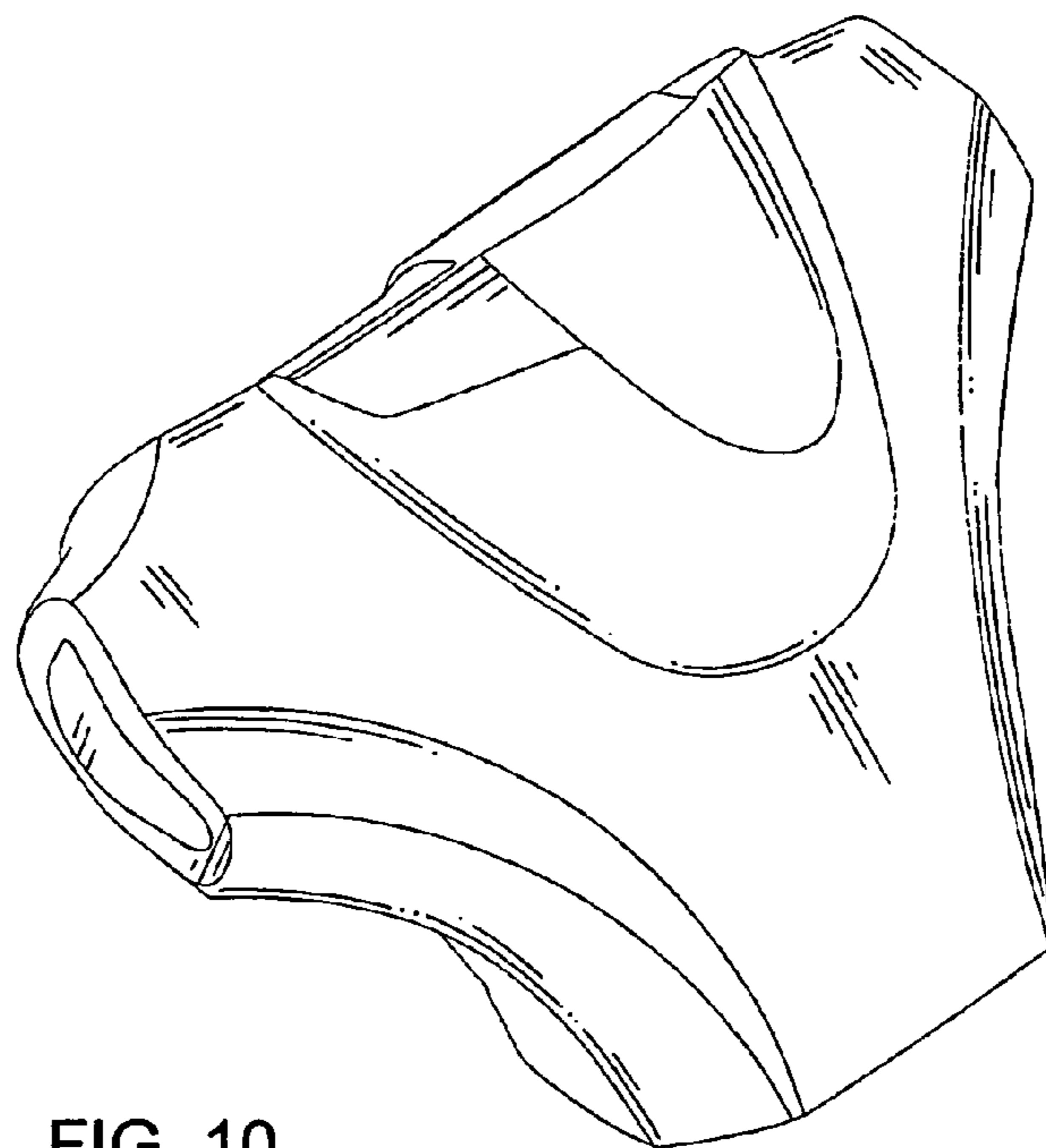

FIG. 10