



US00D719820S

(12) **United States Design Patent**
McGrath

(10) **Patent No.:** **US D719,820 S**

(45) **Date of Patent:** **** Dec. 23, 2014**

(54) **SLIDE SLOT BRACKET**

(71) Applicant: **Andrew H. McGrath**, Concord, CA
(US)

(72) Inventor: **Andrew H. McGrath**, Concord, CA
(US)

(**) Term: **14 Years**

(21) Appl. No.: **29/448,355**

(22) Filed: **Mar. 12, 2013**

(51) **LOC (10) Cl.** **08-08**

(52) **U.S. Cl.**

USPC **D8/382**

(58) **Field of Classification Search**

CPC E02B 15/085; E02B 15/08; A61C 7/287;
B29D 11/00673; H05K 7/02; F16B 9/023;
G01N 2021/1793

USPC D8/382, 349, 354, 399, 384, 386, 383,
D8/310, 394; D11/182, 181; D15/148;
D6/300, 309, 329, 310; D26/140;
220/614; 403/264, 256, 141, 142;
248/229.15, 229.25, 230.1, 466, 490;
112/226

See application file for complete search history.

(56) **References Cited**

U.S. PATENT DOCUMENTS

3,049,323 A * 8/1962 Peterka 248/466
3,583,345 A * 6/1971 Wilson et al. 112/226
D271,376 S * 11/1983 Baroody D8/382

(Continued)

Primary Examiner — Sheryl Lane

Assistant Examiner — Nicole Shiflet

(74) *Attorney, Agent, or Firm* — Charles L. Thoeming

(57) **CLAIM**

The ornamental design for a slide slot bracket, as shown and described.

DESCRIPTION

FIG. 1 is a perspective view from the front, below of a first embodiment of a slide slot bracket showing my new design. FIG. 2 is a perspective view from the rear, above of the slide slot bracket of FIG. 1.

FIG. 3 is a front orthogonal view of the slide slot bracket of FIG. 1.

FIG. 4 is a right side orthogonal view of the slide slot bracket of FIG. 1; a left side orthogonal view of the slide slot bracket of FIG. 1 is the mirror image of FIG. 4.

FIG. 5 is a rear orthogonal view of the slide slot bracket of FIG. 1.

FIG. 6 is a top orthogonal view of the slide slot bracket of FIG. 1.

FIG. 7 is a bottom orthogonal view of the slide slot bracket of FIG. 1.

FIG. 8 is a perspective view of the first embodiment of slide slot bracket of FIG. 1 in a sneeze guard environment.

FIG. 9 is a perspective view of a second embodiment of a slide slot bracket showing my new design.

FIG. 10 is a perspective view from the rear, above of the slide slot bracket of FIG. 9.

FIG. 11 is a front orthogonal view of the slide slot bracket of FIG. 9.

FIG. 12 is a right side orthogonal view of the slide slot bracket of FIG. 9; a left side orthogonal view of the slide slot bracket of FIG. 9 is the mirror image of FIG. 12.

FIG. 13 is a rear orthogonal view of the slide slot bracket of FIG. 9.

FIG. 14 is a top orthogonal view of the slide slot bracket of FIG. 9.

FIG. 15 is a bottom orthogonal view of the slide slot bracket of FIG. 9; and,

FIG. 16 is a perspective view of the second embodiment of slide slot bracket of FIG. 9 in a sneeze guard environment.

The broken lines in FIG. 8 and FIG. 16 show environmental structure and form no part of the claimed design.

1 Claim, 2 Drawing Sheets

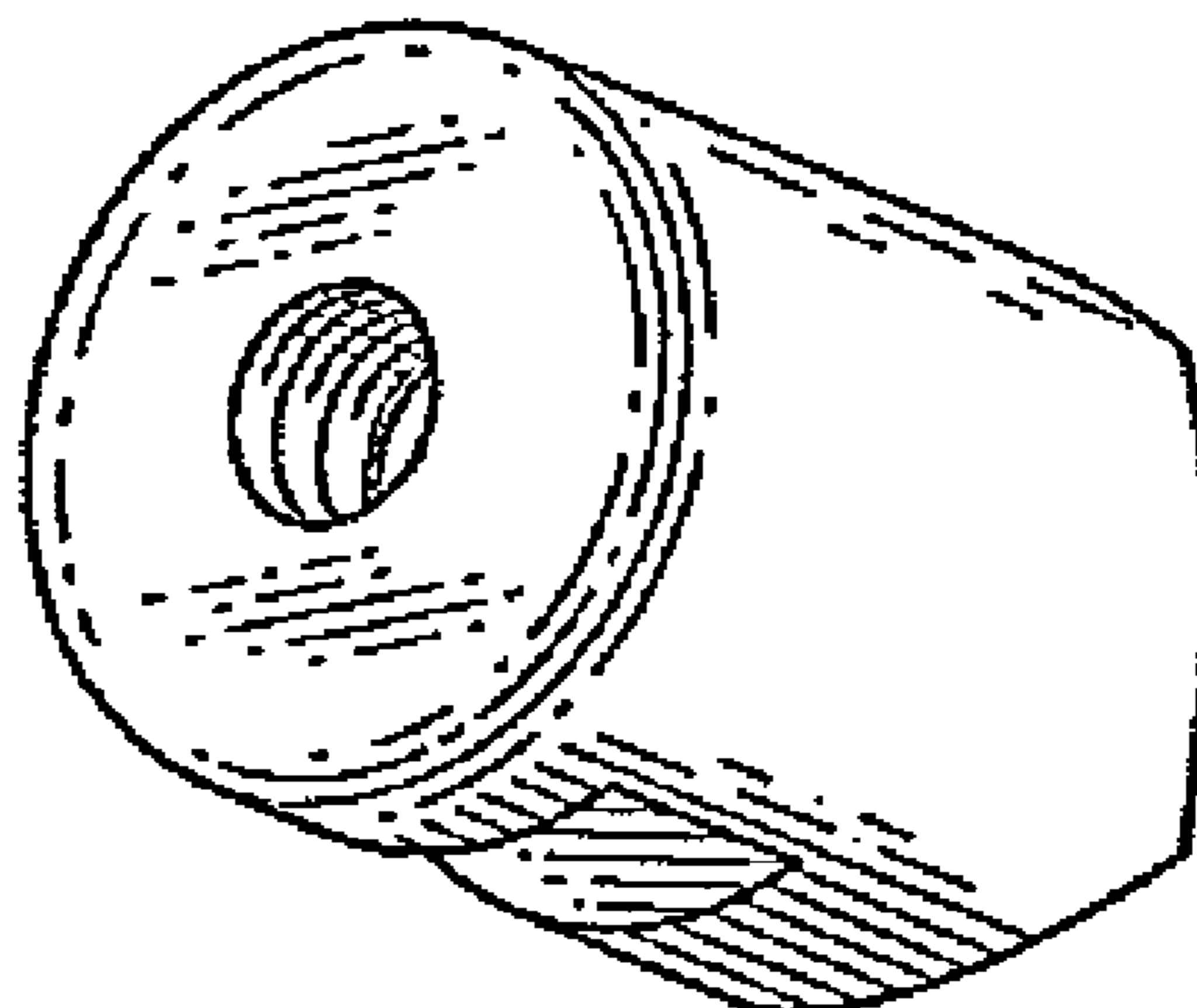
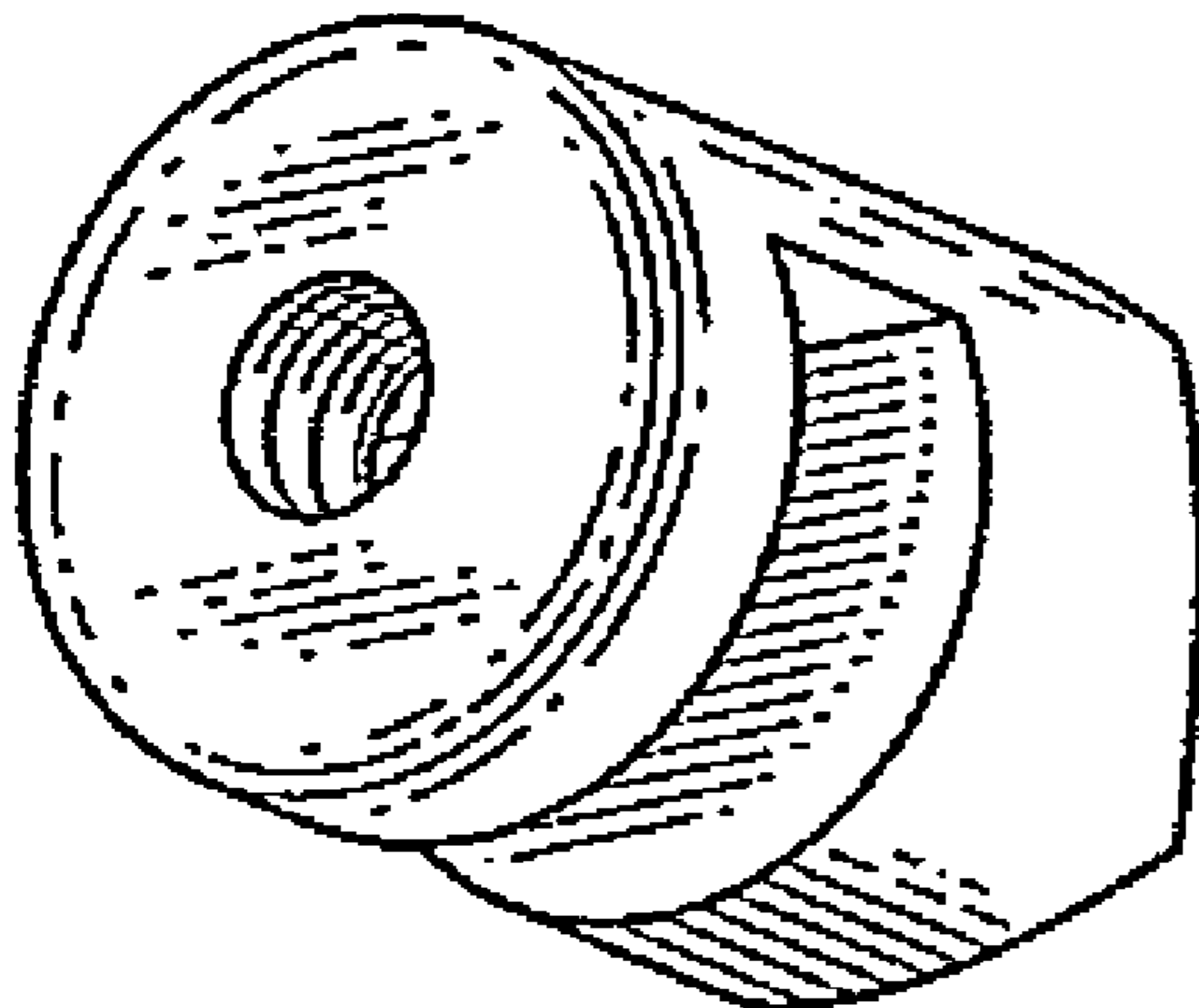

US D719,820 S

Page 2

(56)

References Cited

U.S. PATENT DOCUMENTS

4,783,189 A * 11/1988 Bugg 403/264
D306,911 S * 3/1990 Evenson et al. D26/140

D335,394 S * 5/1993 Chamlian D6/310
D535,869 S * 1/2007 Brunsteter D8/382
7,588,223 B2 * 9/2009 Wolvin 248/229.15
8,752,803 B2 * 6/2014 Goldberg et al. 248/490

* cited by examiner

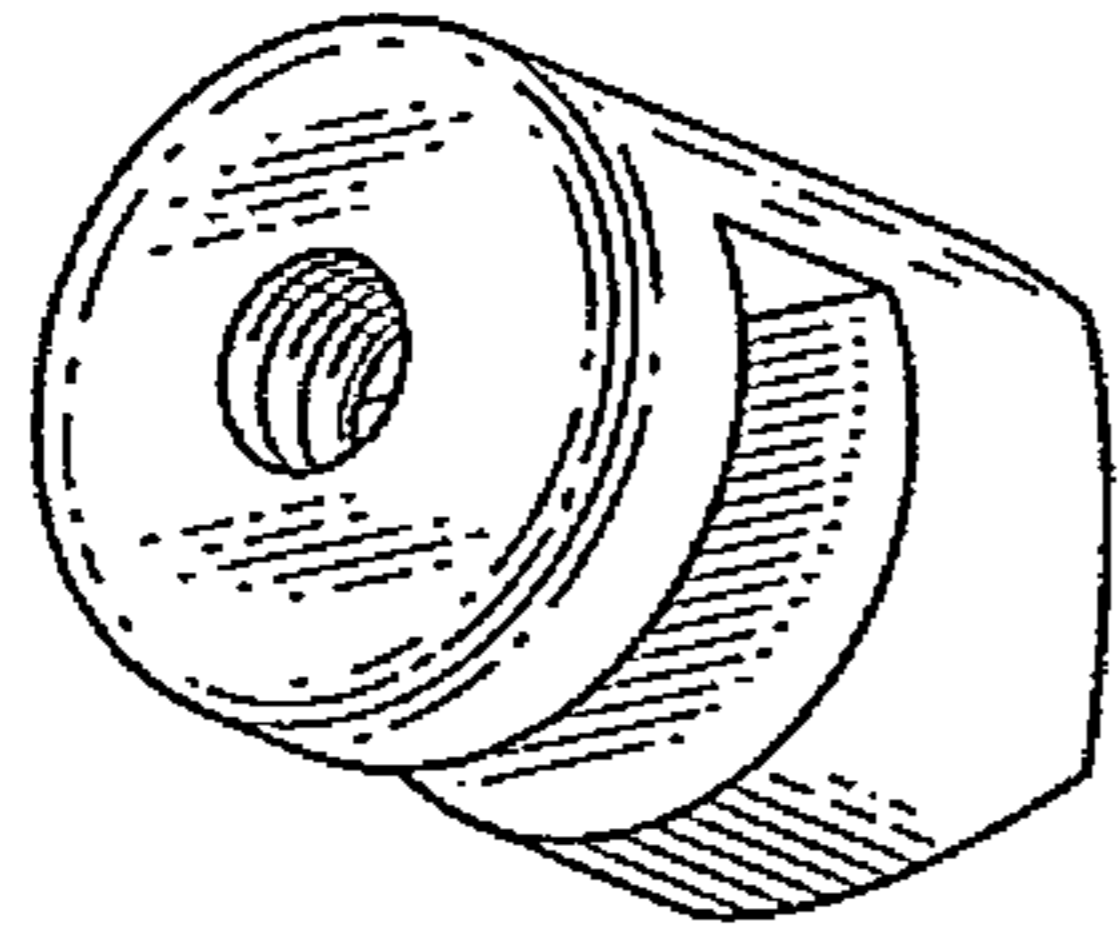

Fig. 1

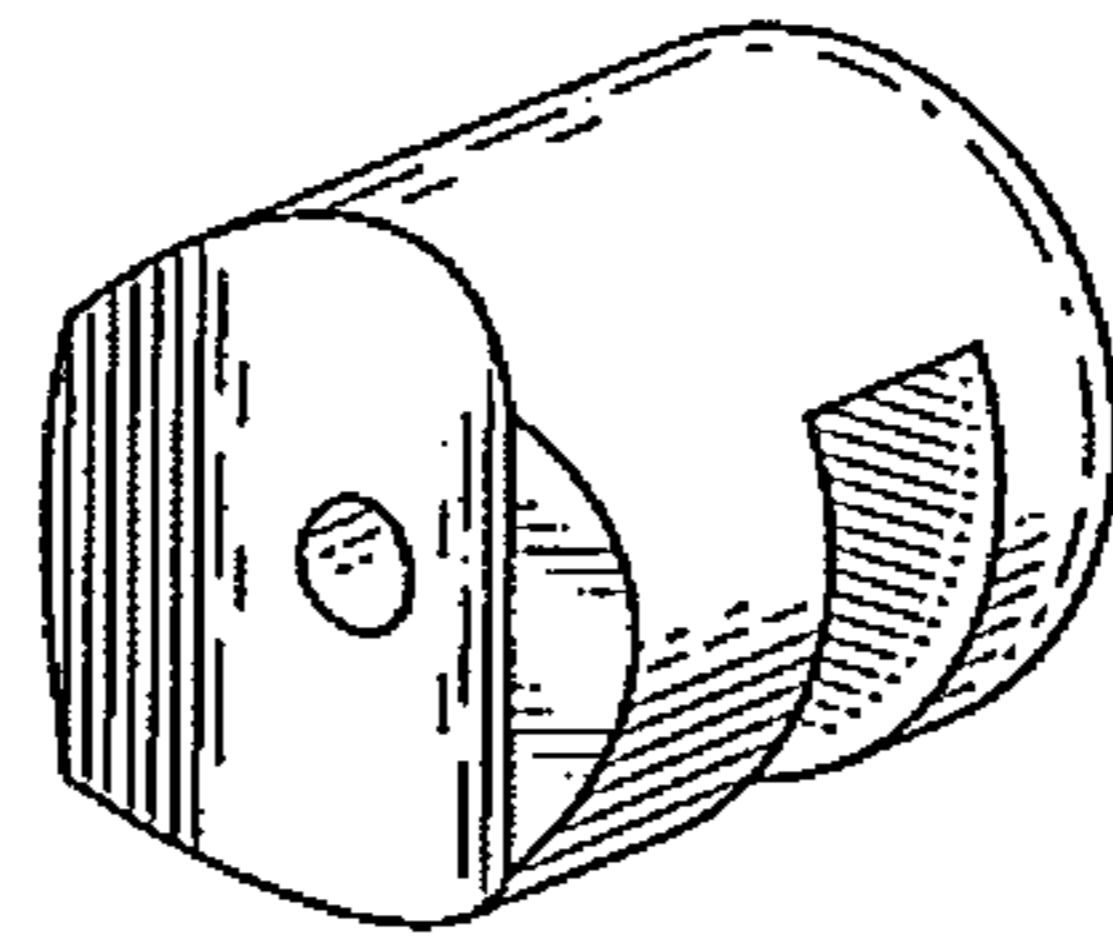

Fig. 2

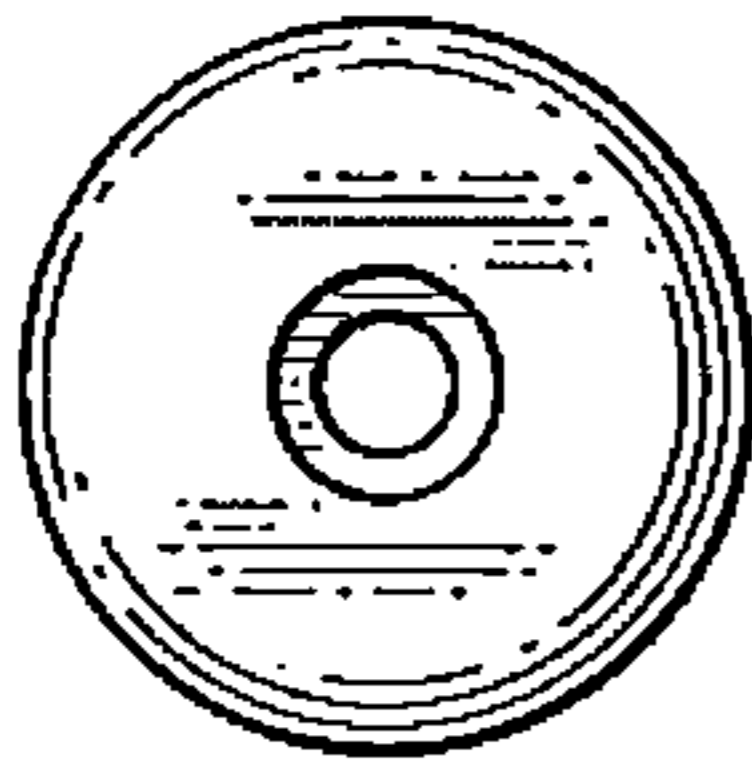

Fig. 3

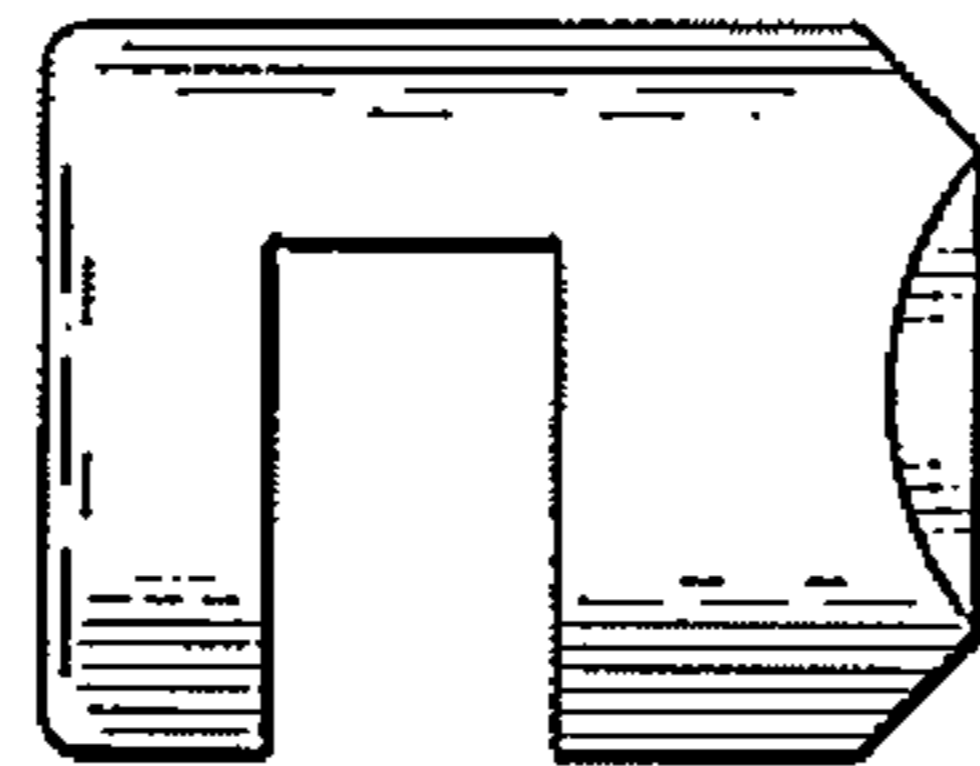

Fig. 4

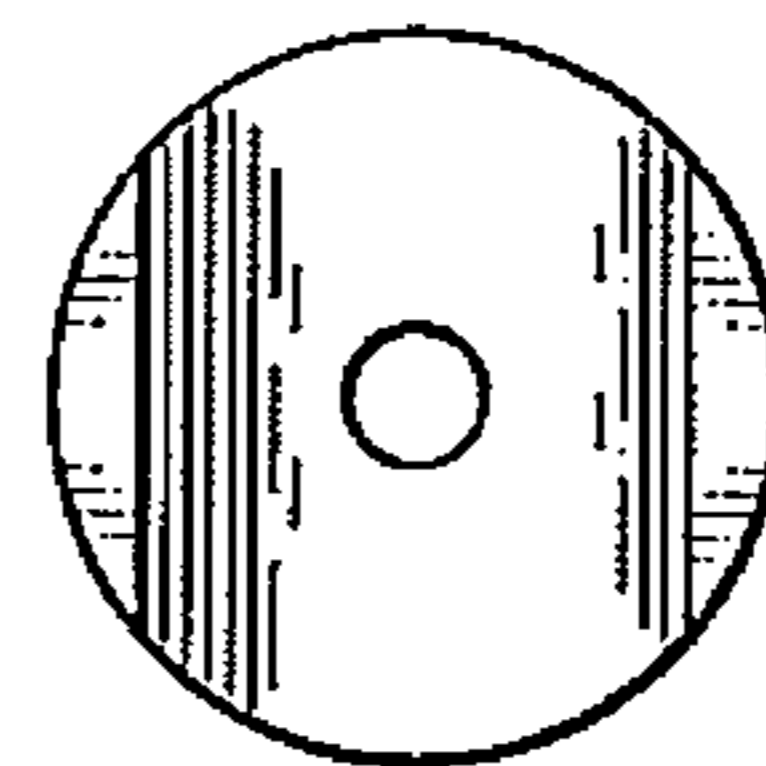

Fig. 5

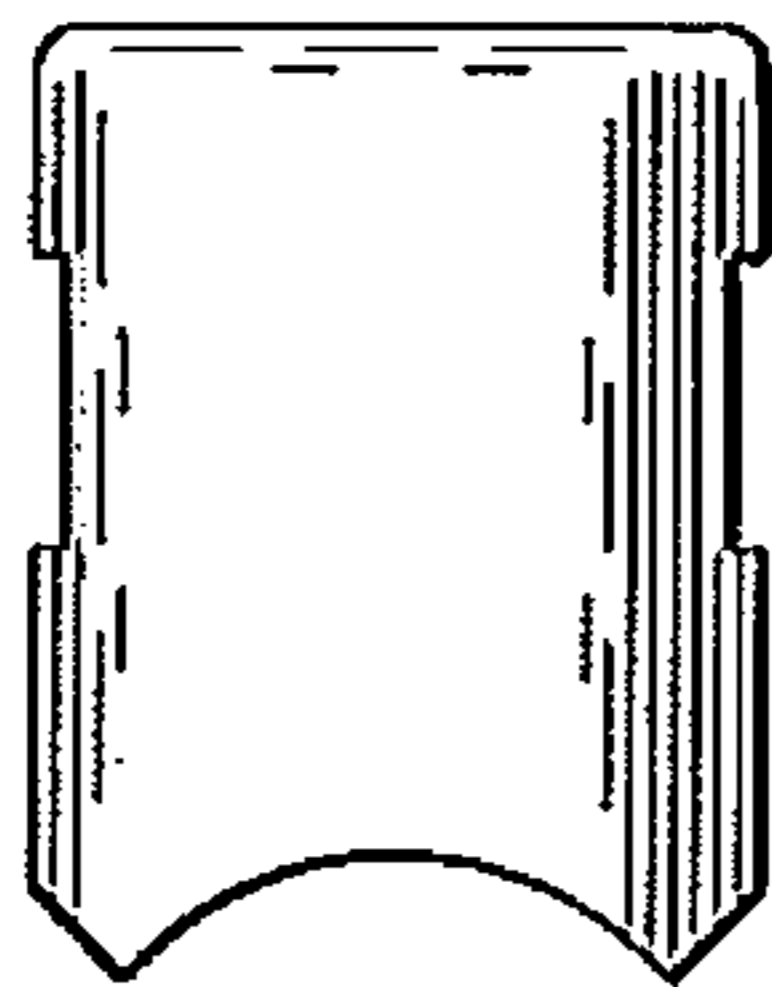

Fig. 6

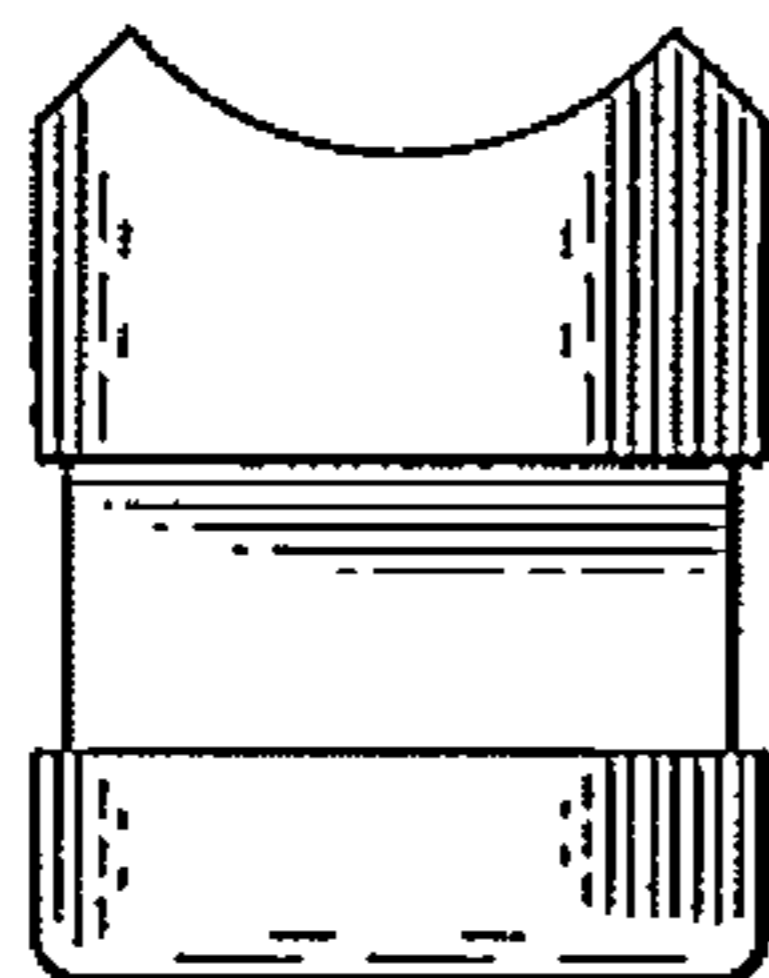

Fig. 7

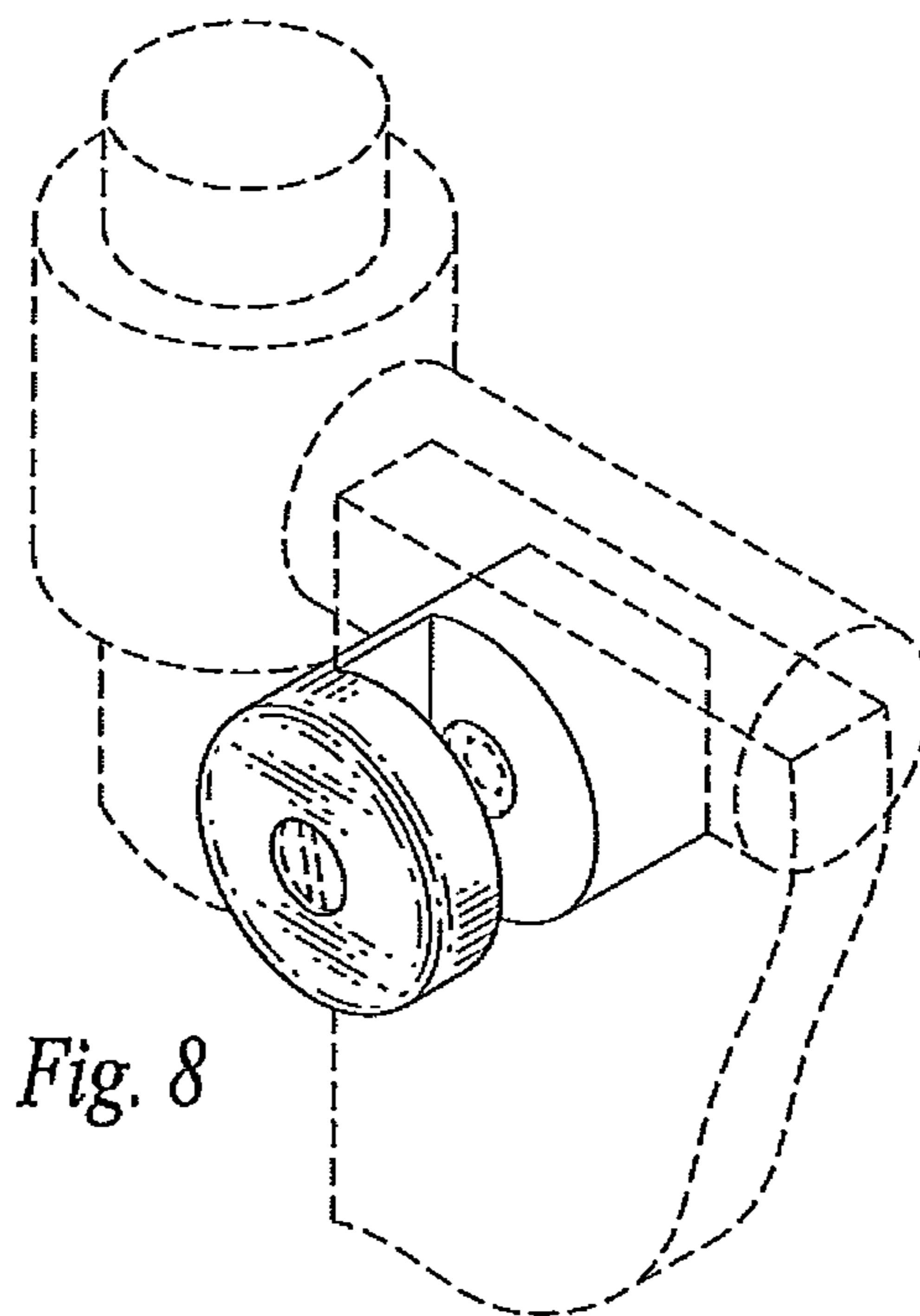

Fig. 8

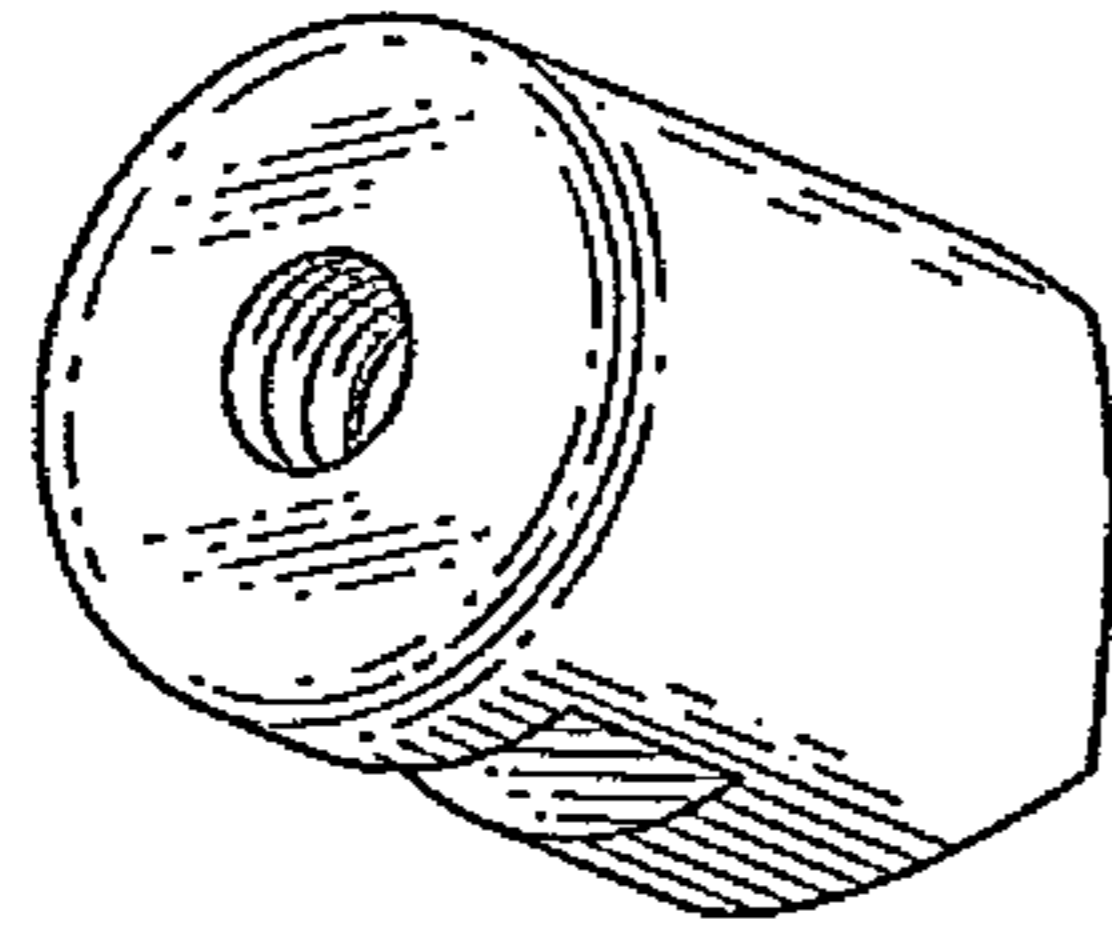

Fig. 9

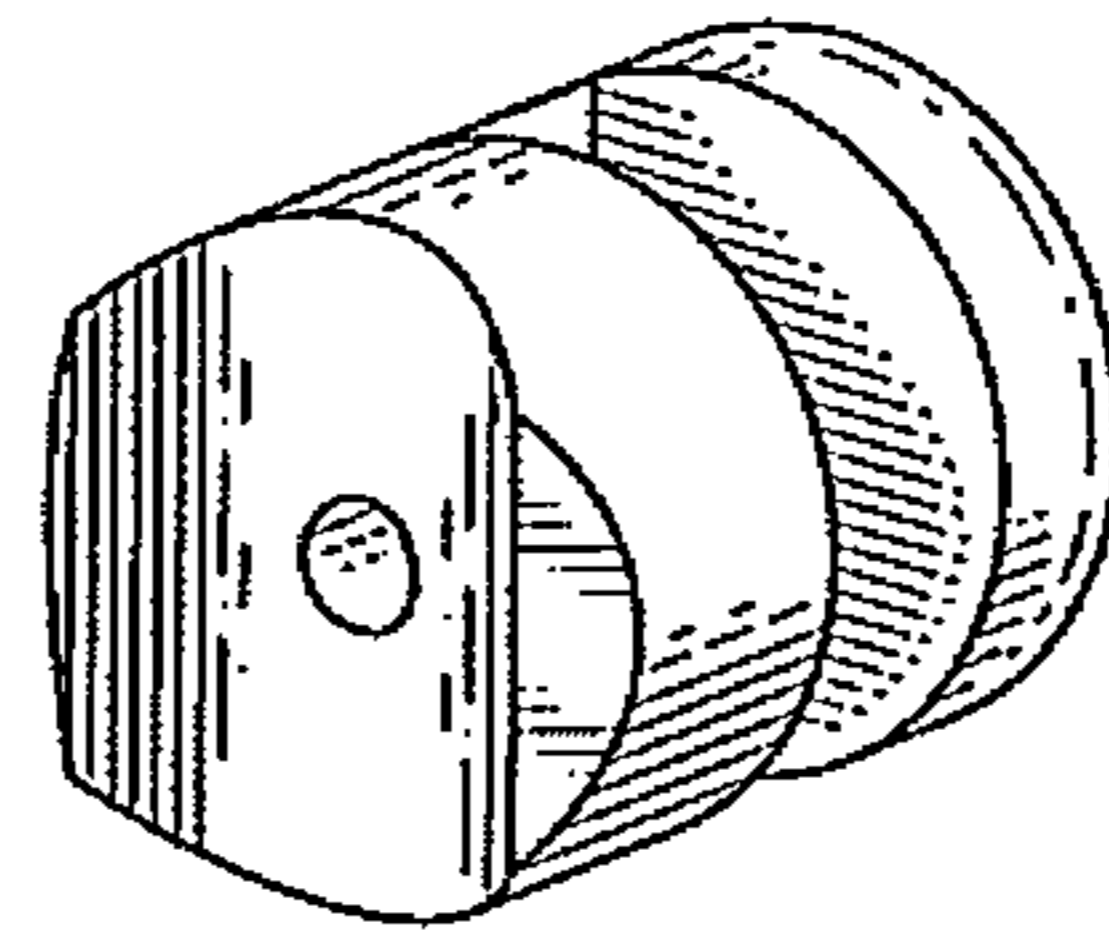

Fig. 10

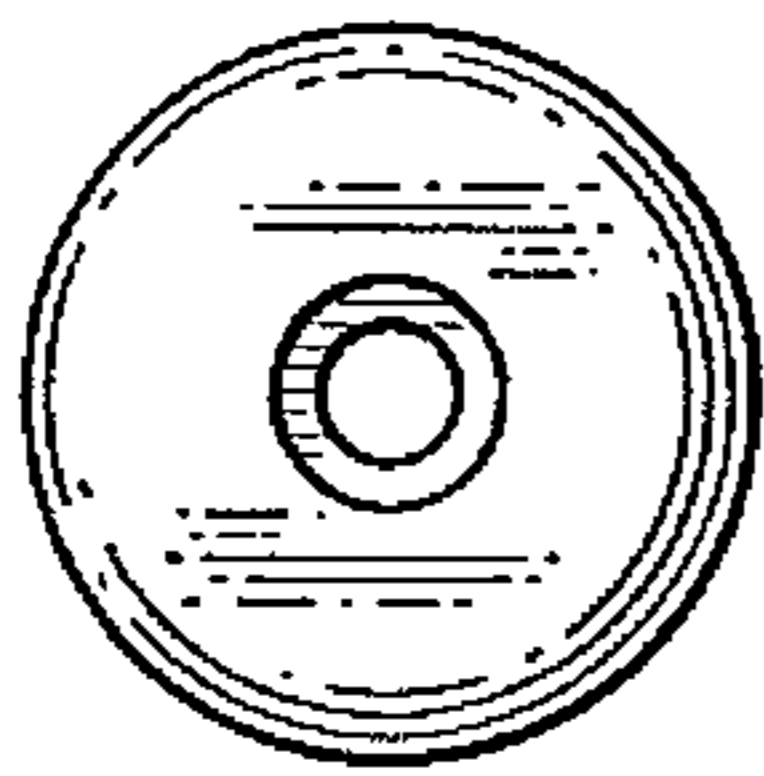

Fig. 11

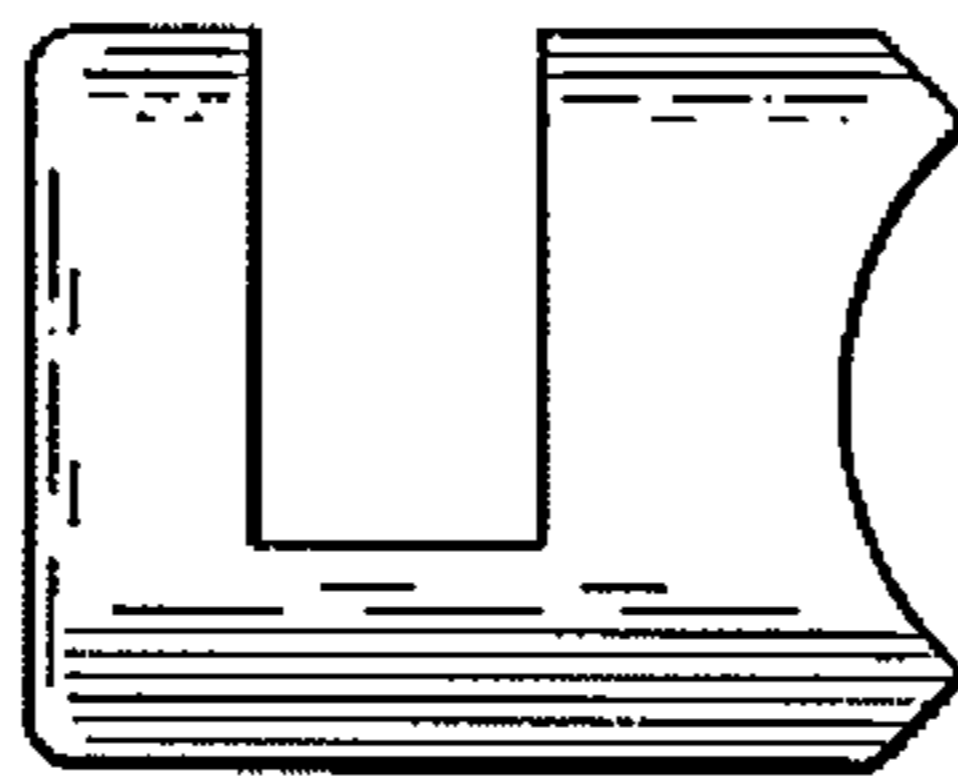

Fig. 12

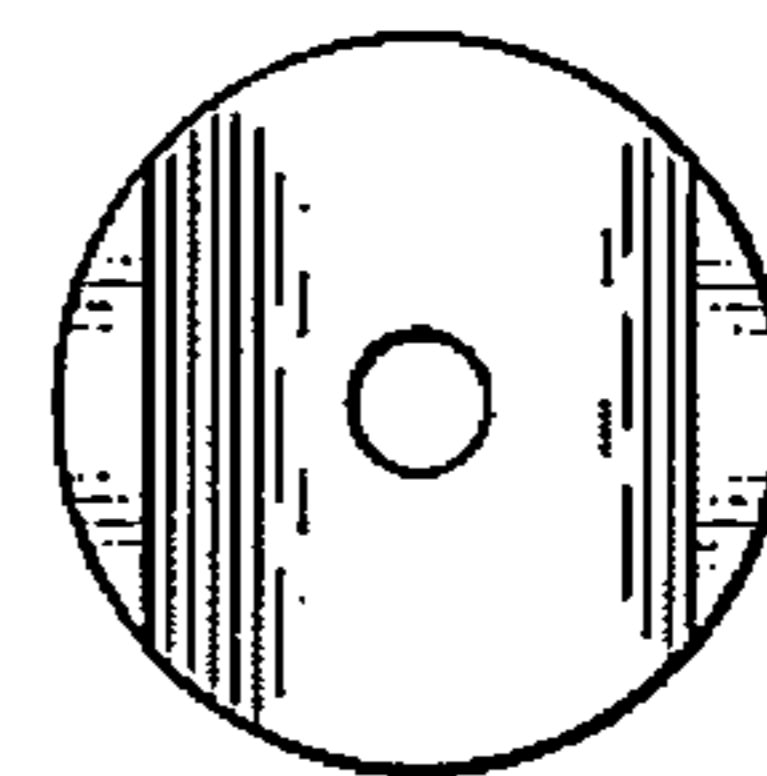

Fig. 13

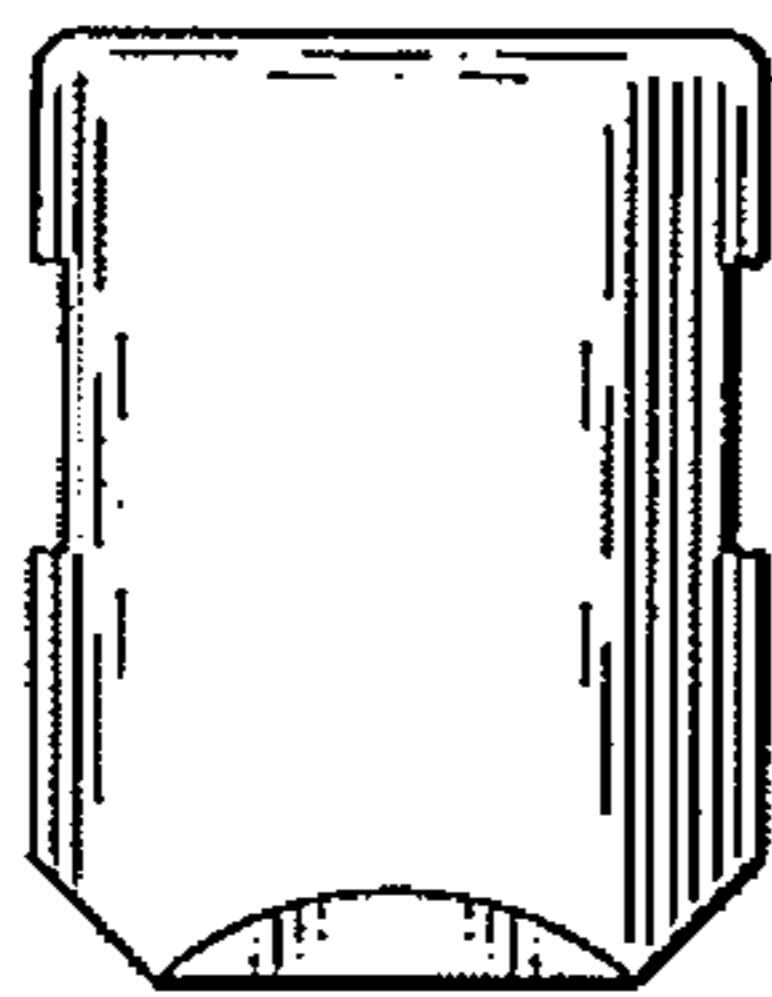

Fig. 14

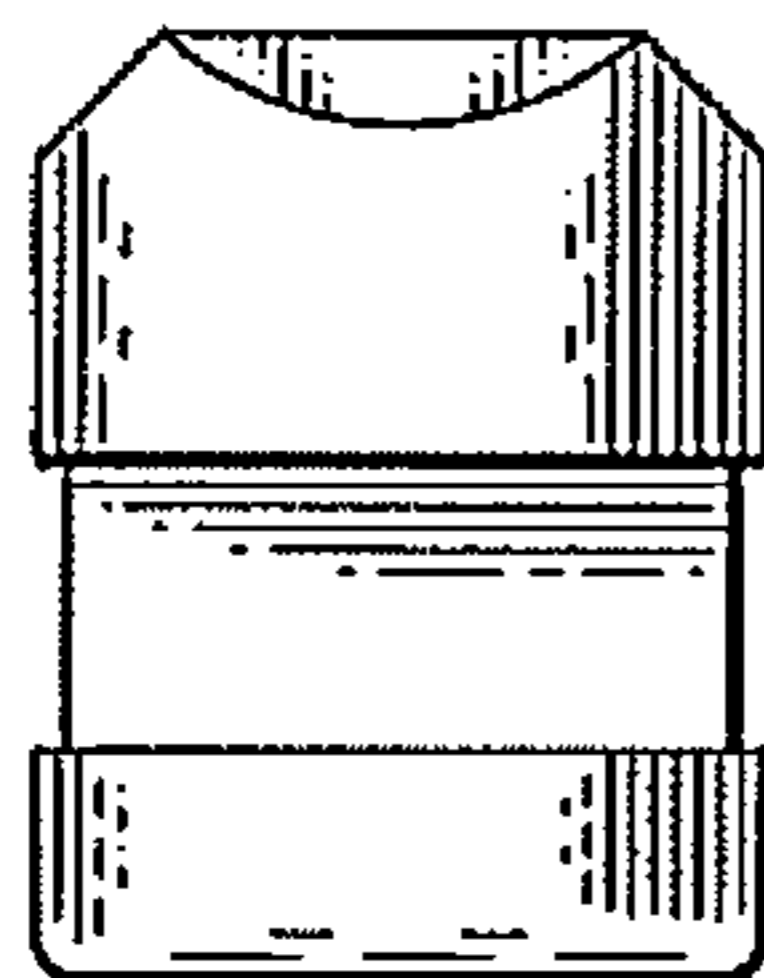

Fig. 15

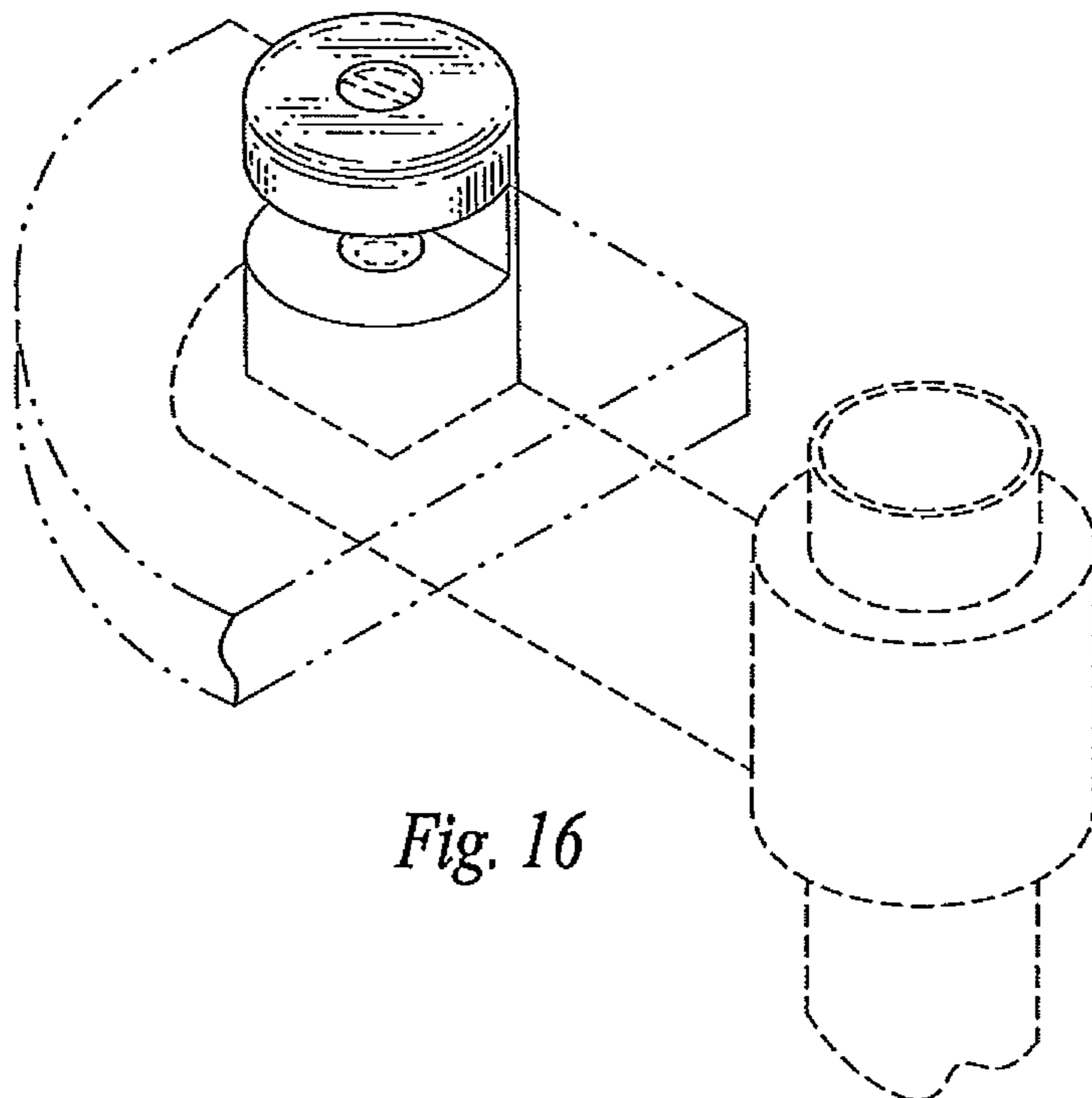

Fig. 16