



US00D719800S

(12) **United States Design Patent**
Johnson

(10) **Patent No.:** **US D719,800 S**
(45) **Date of Patent:** **** Dec. 23, 2014**

- (54) **TIMING BELT SPACER TOOL**
- (75) Inventor: **Scott Johnson**, Narre Warren (AU)
- (73) Assignee: **The Gates Corporation**, Denver, CO (US)
- (**) Term: **14 Years**
- (21) Appl. No.: **29/418,207**
- (22) Filed: **Apr. 13, 2012**
- (51) **LOC (10) Cl.** **08-05**
- (52) **U.S. Cl.**
USPC **D8/14**
- (58) **Field of Classification Search**
CPC B25B 27/0035; B25B 27/14; F01L 1/02;
F01L 1/024; F01L 1/053; F01L 2001/0537;
F01L 2103/01; F16G 3/08; F16G 3/16
USPC D8/14, 356, 396, 499; 24/31 R; 29/271,
29/281.5, 281.6
See application file for complete search history.

(56) **References Cited**

U.S. PATENT DOCUMENTS

D227,742 S *	7/1973	Logdson	D8/354
D279,959 S *	8/1985	Nimmo et al.	D8/396
D299,213 S *	1/1989	Puntillo	D8/395
D344,449 S *	2/1994	Ward	D8/395
D408,273 S *	4/1999	Senninger	D8/356
6,058,585 A *	5/2000	Soleymani	29/281.6
D438,453 S *	3/2001	Nelson et al.	D8/395
6,332,256 B1 *	12/2001	Dawson	29/281.5
6,698,075 B1 *	3/2004	Wu	29/281.5
7,047,610 B2 *	5/2006	Dawson	29/281.1
7,055,230 B2 *	6/2006	Wu	29/281.5
D526,743 S *	8/2006	Battista et al.	D27/161
7,225,517 B2 *	6/2007	Mitchell	29/281.5

D609,084 S *	2/2010	Traficante et al.	D8/396
7,752,727 B2 *	7/2010	Mitchell	29/281.5
8,307,527 B2 *	11/2012	Huang	29/281.5
2004/0042848 A1 *	3/2004	Dawson	403/374.3
2008/0060171 A1 *	3/2008	Lindemann	24/31 R

OTHER PUBLICATIONS

Gates Timing Subaru Spacer Tool. Snagged Sep. 7, 2014 from <http://www.gates.com/products/automotive/tools-and-sales-aids/professional-tools/subaru-spacer-tool>.*

* cited by examiner

Primary Examiner — Phillip S Hyder
Assistant Examiner — Roselynn Cody

(74) *Attorney, Agent, or Firm* — Paul N. Dunlap, Esq.; Jeffrey A. Thurnau, Esq.

(57) **CLAIM**

The ornamental design for a timing belt spacer tool, as shown and described.

DESCRIPTION

FIG. 1 is a front-top perspective view.
 FIG. 2 is a front elevation view.
 FIG. 3 is a cross-sectional view at line 3-3 in FIG. 2.
 FIG. 4 is a side elevation view.
 FIG. 5 is a top plan view.
 FIG. 6 is a rear elevation view.
 FIG. 7 is a rear-bottom perspective view; and,
 FIG. 8 is a bottom plan view.
 The side cross-sectional view at line 3-3 in FIG. 2 to the right would be the mirror image of FIG. 3. The other side elevation view would be the mirror image of FIG. 4.
 The broken lines in FIGS. 1, 5, 7, and 8 illustrate a feature of the timing belt spacer tool that forms no part of the claim.

1 Claim, 3 Drawing Sheets

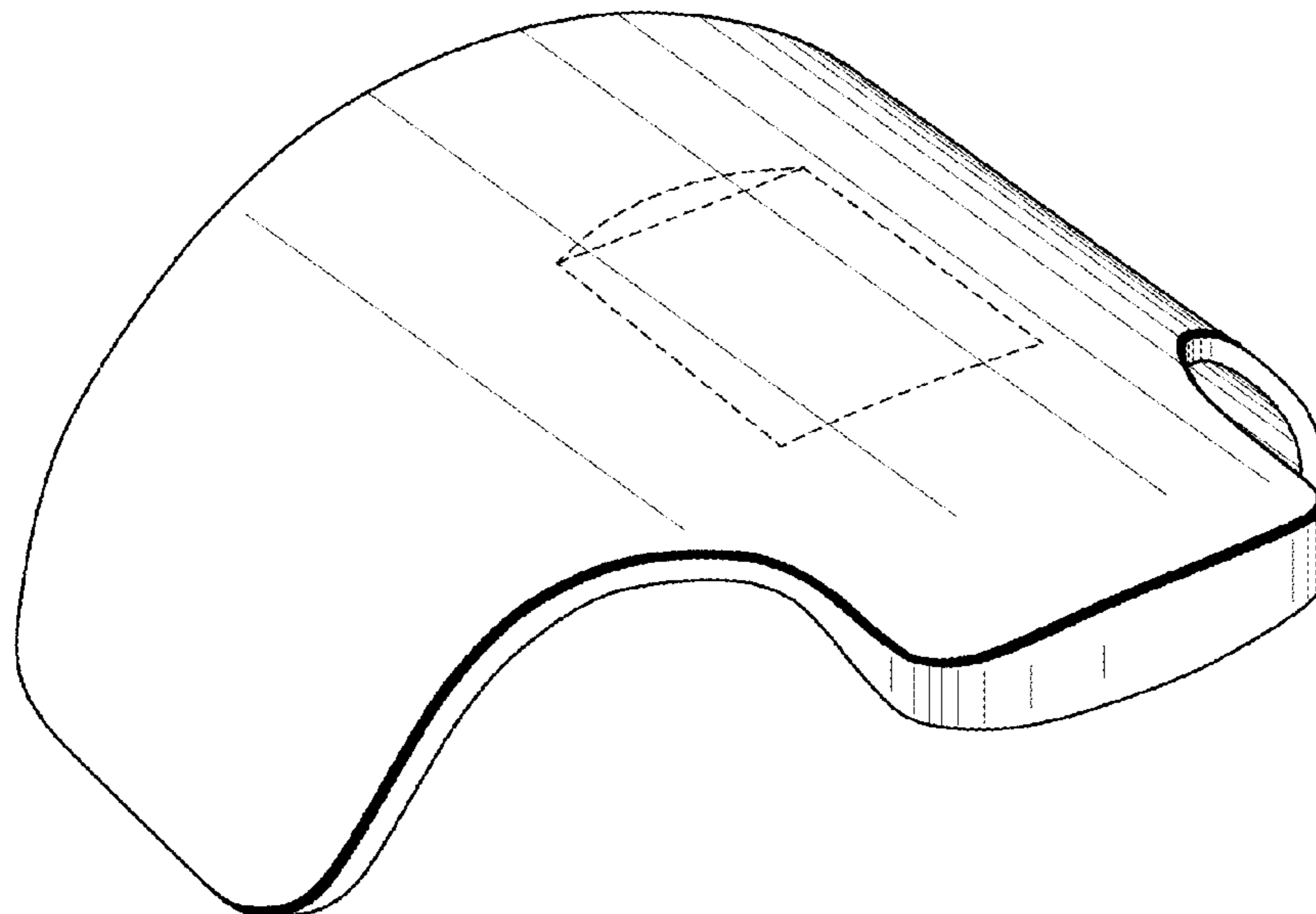

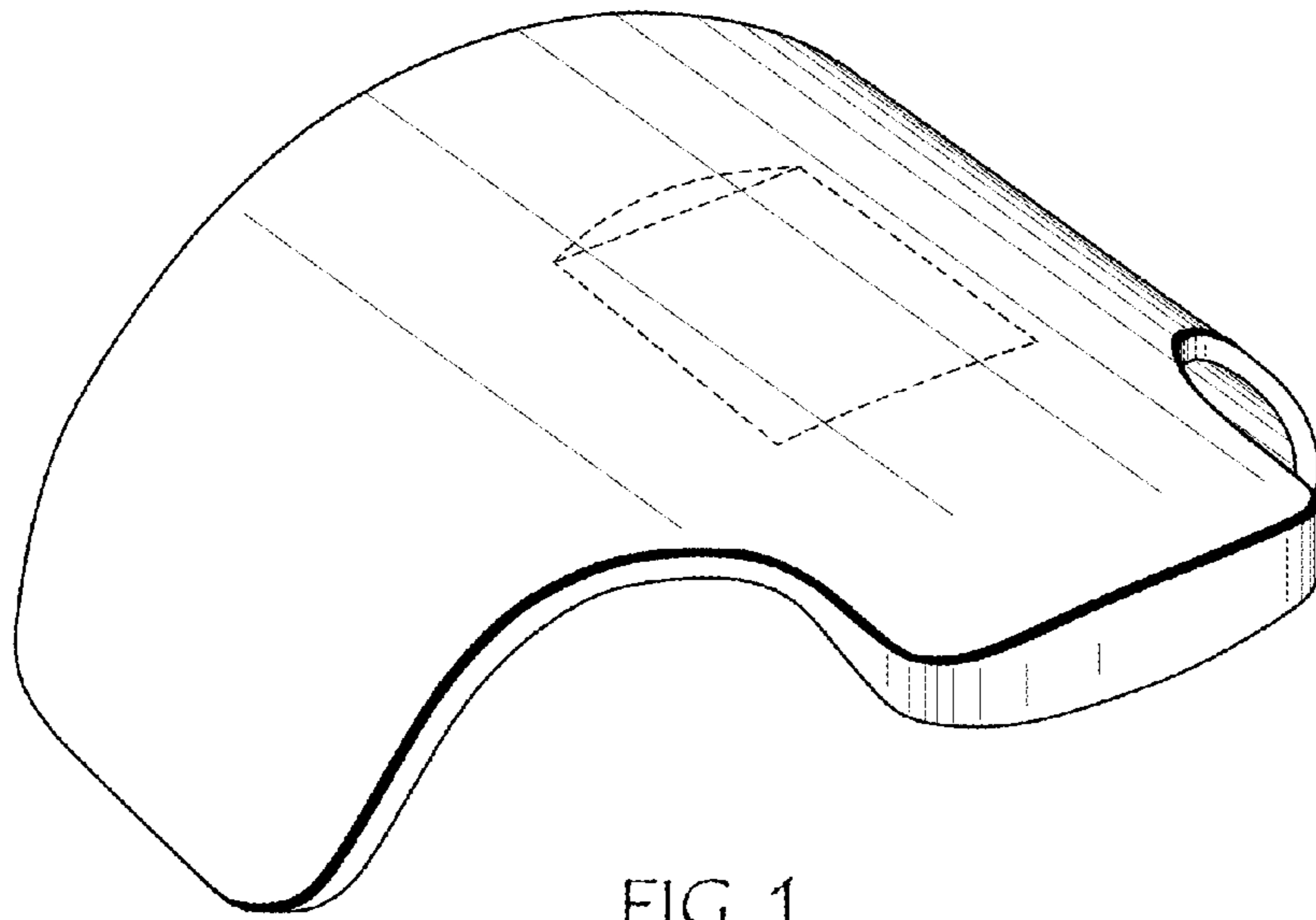
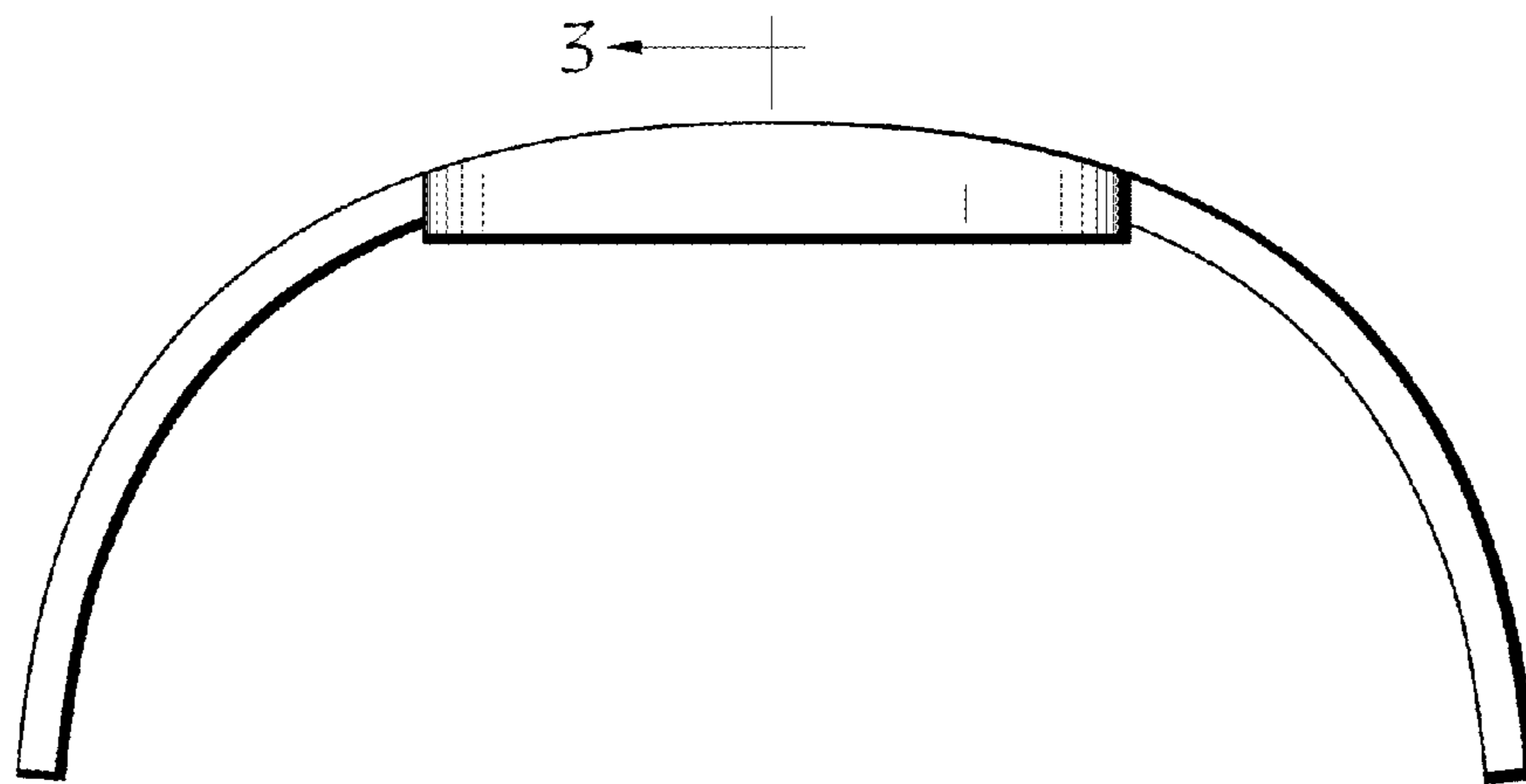

FIG. 1



3 ←

3 ←

FIG. 2

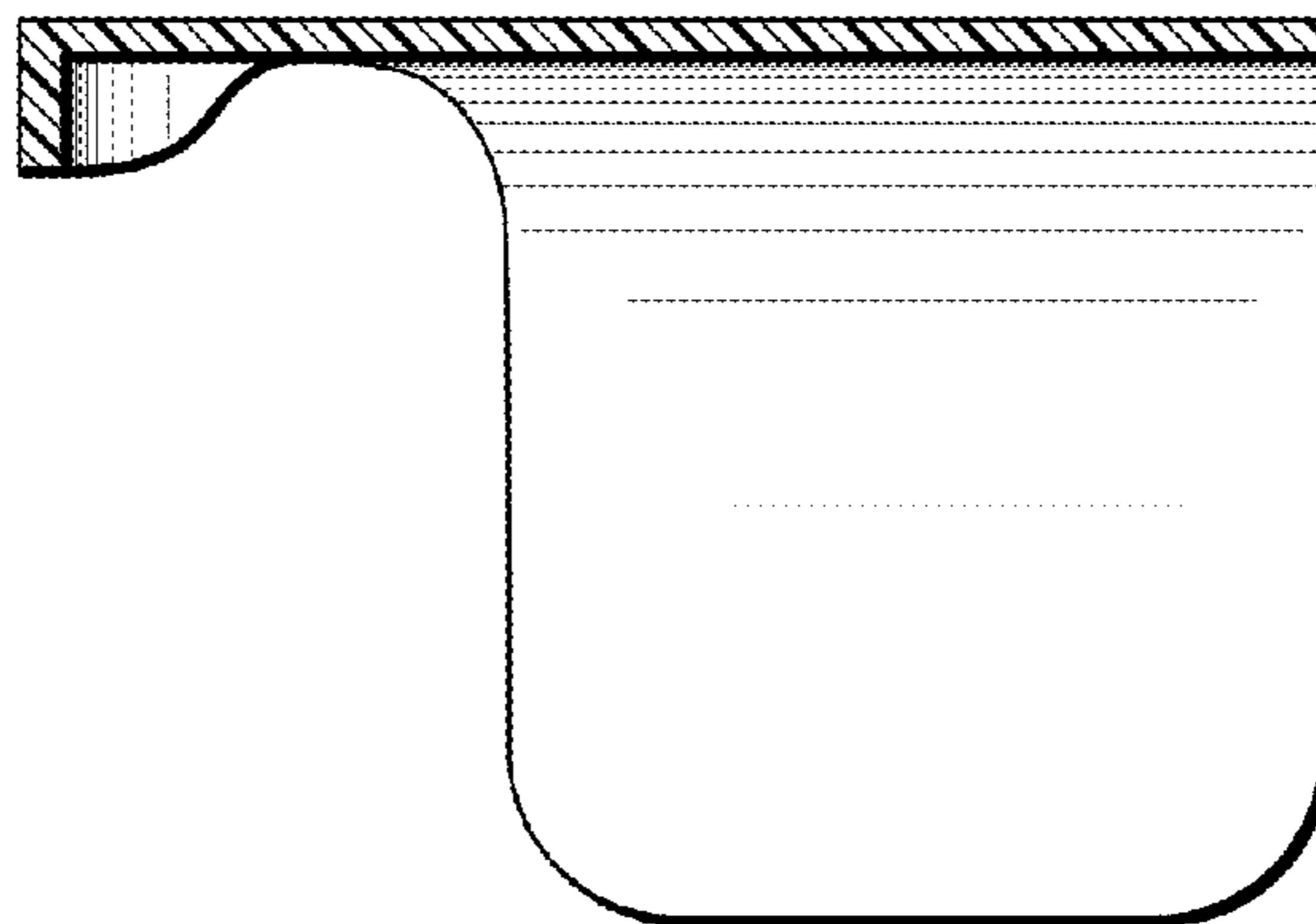

FIG. 3

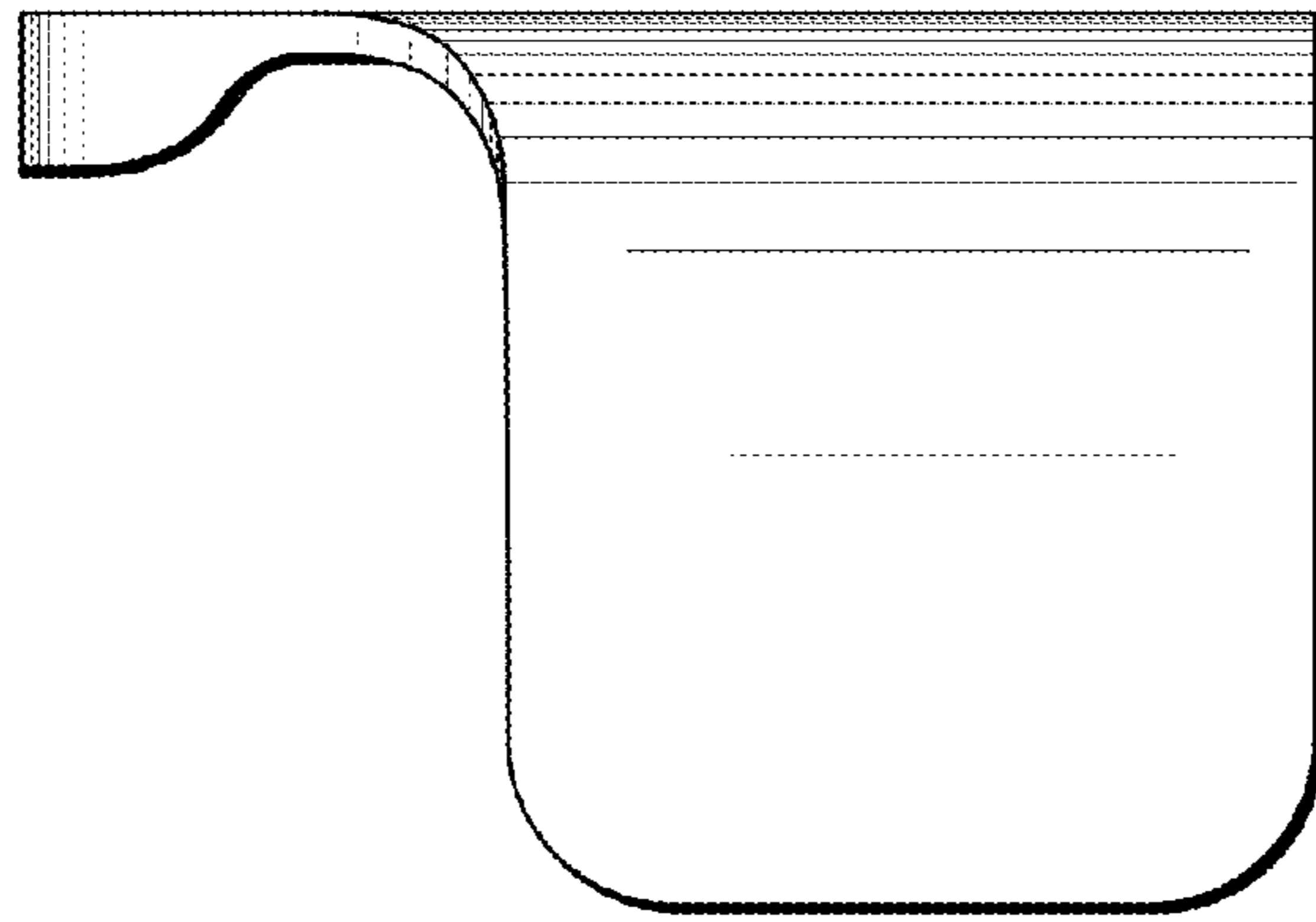

FIG. 4

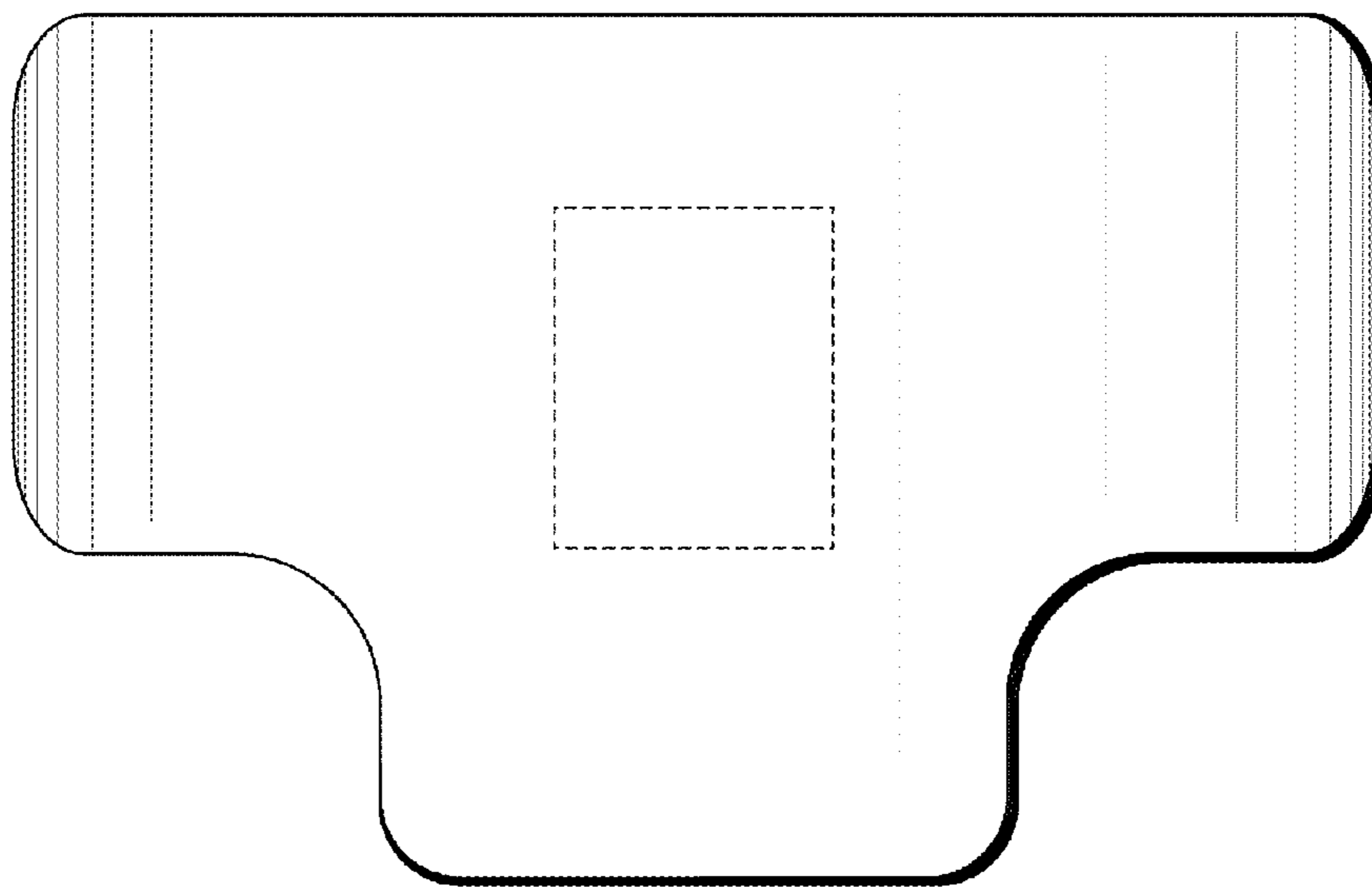

FIG. 5

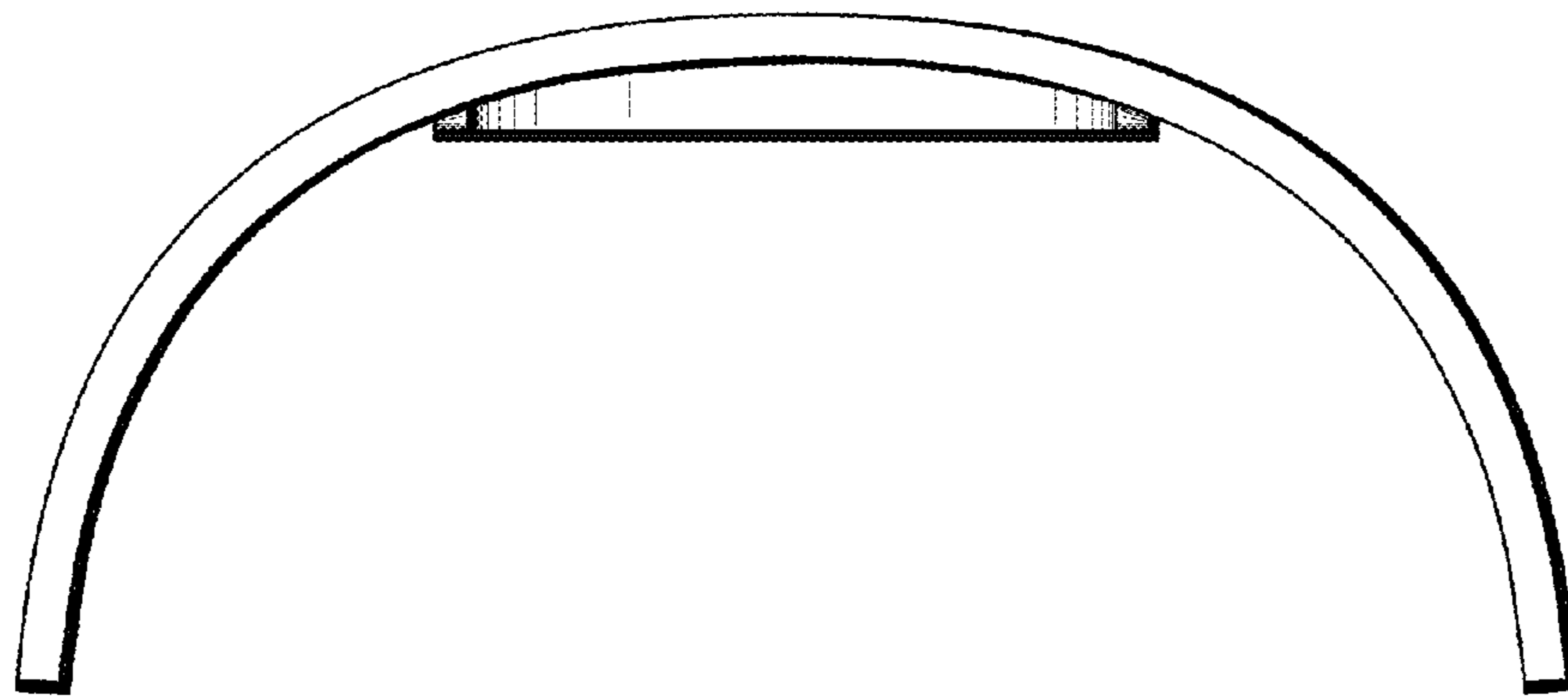

FIG. 6

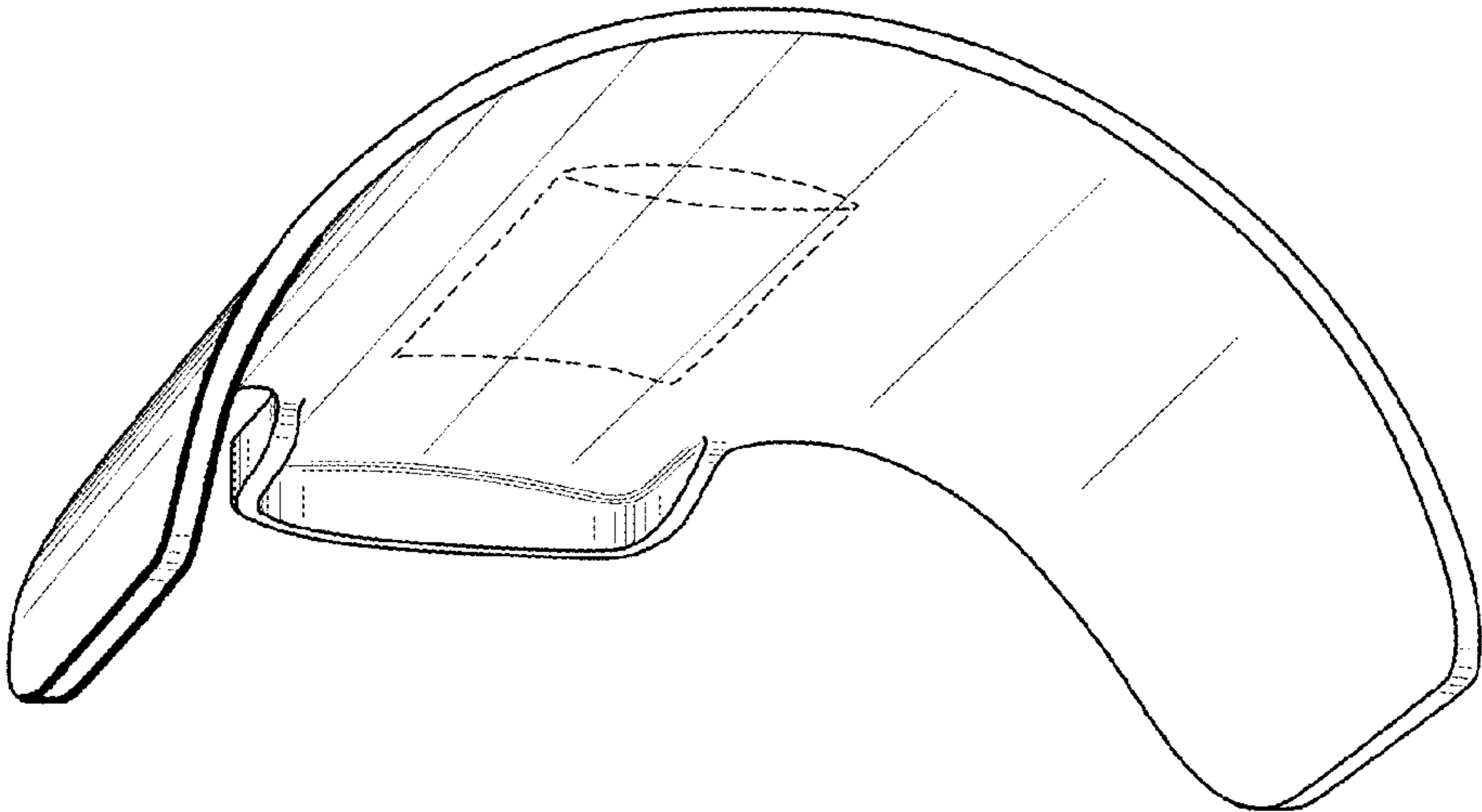

FIG. 7

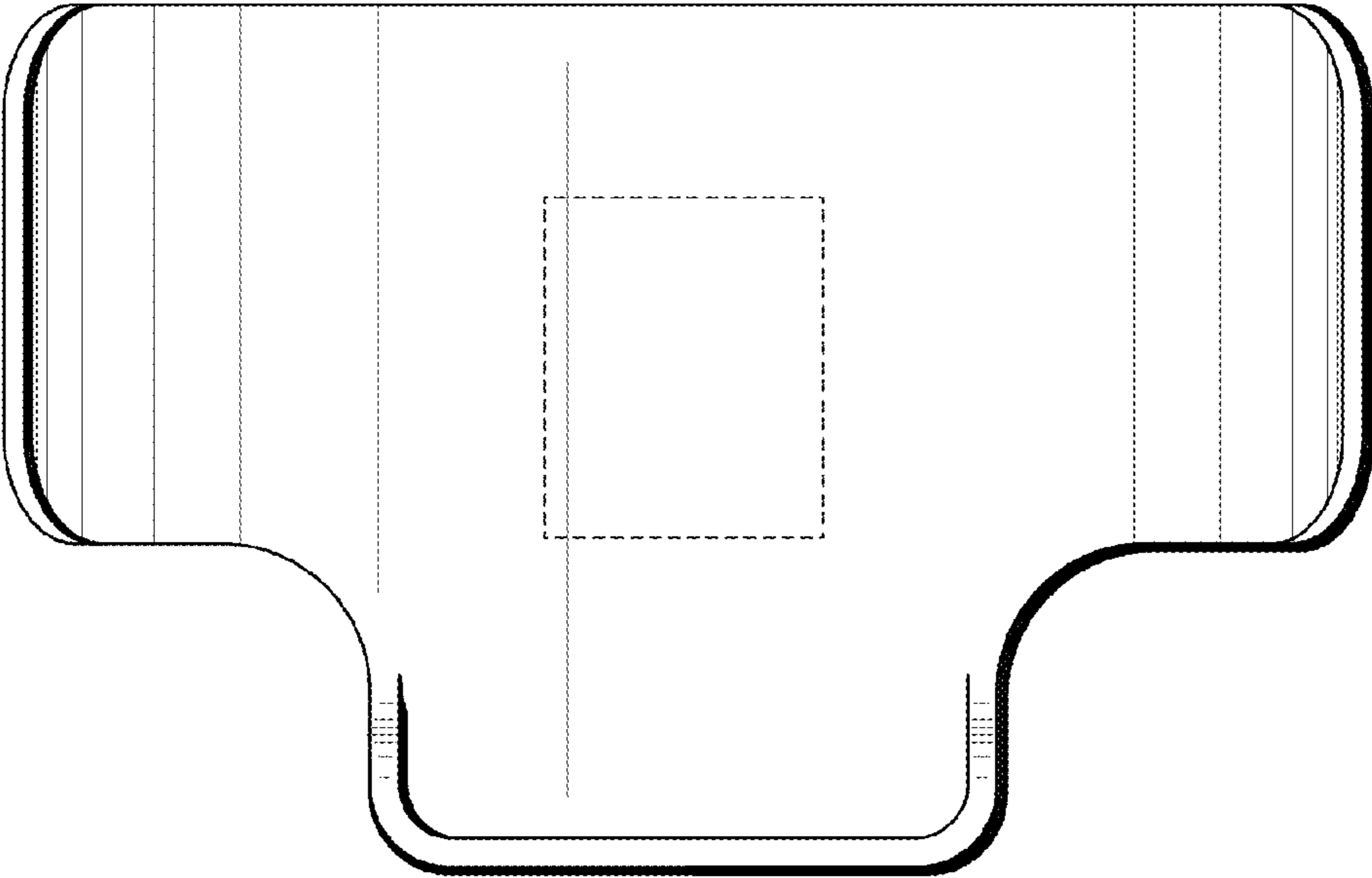

FIG. 8