



US00D719798S

(12) **United States Design Patent**
Thompson et al.

(10) **Patent No.:** **US D719,798 S**

(45) **Date of Patent:** **** Dec. 23, 2014**

(54) **DRILL TIE STAKE**

3,785,610 A 1/1974 Dagiel
3,870,428 A 3/1975 Jackson
3,877,340 A 4/1975 Knohl

(71) Applicant: **Drill Tie Systems, Inc.**, Hialeah, FL
(US)

(Continued)

(72) Inventors: **Karen Thompson**, Pembroke Pines, FL
(US); **Jeffery Homberger**, Satellite
Beach, FL (US); **Thomas Homberger**,
Palm Beach Gardens, FL (US)

FOREIGN PATENT DOCUMENTS

JP 59228510 12/1984

(73) Assignee: **Drill Tie Systems, Inc.**, Hialeah, FL
(US)

OTHER PUBLICATIONS
Milliken, Milliken Concrete Cloth, brochure, copyright 2011-2013, 1
page.

(**) Term: **14 Years**

(Continued)

(21) Appl. No.: **29/438,845**

Primary Examiner — Sheryl Lane

(22) Filed: **Dec. 4, 2012**

(74) *Attorney, Agent, or Firm* — Brian S. Steinberger; Law
Offices of Brian S. Steinberger, P.A.

(51) **LOC (10) Cl.** **08-01**

(52) **U.S. Cl.**
USPC **D8/1; D8/391**

(58) **Field of Classification Search**
USPC D8/1, 386, 391, 387, 397, 388;
411/439, 480, 533, 482, 542, 923;
D15/139; D26/138; D21/840;
47/43-47; 135/118; 248/156;
405/259.1, 302.7

(57) **CLAIM**

The ornamental design for a drill tie stake, as shown and
described.

See application file for complete search history.

DESCRIPTION

FIG. 1 shows an upper front right perspective view of the
novel drill tie stake with washer.

FIG. 2 is a lower rear left perspective view of the drill tie stake
with washer of FIG. 1.

FIG. 3 is an upper side view of the drill tie stake with washer
of FIG. 1.

FIG. 4 is a lower side view of the drill tie stake with washer of
FIG. 1.

FIG. 5 is a right side view of the drill tie stake with washer of
FIG. 1.

FIG. 6 is a left side view of the drill tie stake with washer of
FIG. 1.

FIG. 7 is a rear end view of the drill tie stake with washer of
FIG. 1; and,

FIG. 8 is a head end view of the drill tie stake with washer of
FIG. 1.

(56) **References Cited**

U.S. PATENT DOCUMENTS

360,225 A 3/1887 Kanters
746,006 A 12/1903 Brigham
907,423 A 9/1910 Cunningham
970,423 A 9/1910 Cunningham
1,144,700 A 6/1915 Edwards
1,497,859 A 6/1924 Lilly
1,767,565 A 6/1930 Thrift
2,840,092 A 6/1958 Hill
2,913,204 A 11/1959 Stewart
3,237,904 A 3/1966 Abruzese
3,570,254 A 3/1971 Turzillo

1 Claim, 4 Drawing Sheets

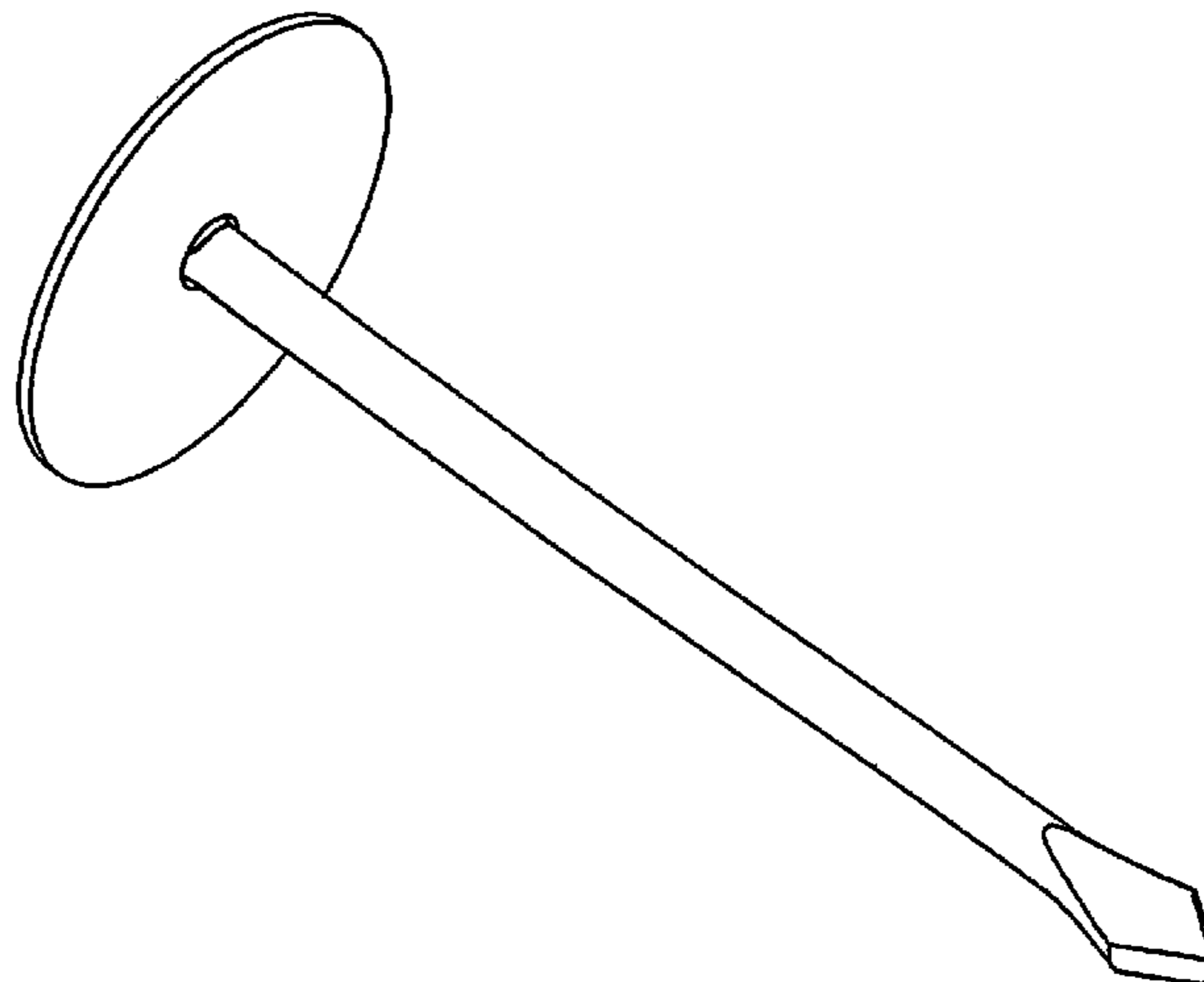

(56)

References Cited

U.S. PATENT DOCUMENTS

3,921,495 A 11/1975 Braun
 D240,362 S * 6/1976 Russo D25/131
 D245,757 S * 9/1977 Fisher et al. D8/391
 4,312,464 A 1/1982 Treiman
 D285,409 S * 9/1986 Lemkin et al. D8/356
 4,610,568 A 9/1986 Koerner
 D300,508 S * 4/1989 Viening D8/391
 5,058,315 A 10/1991 Wagner
 5,063,724 A 11/1991 Vanden Boogaart
 5,109,896 A * 5/1992 Tomes et al. 144/30
 D335,076 S * 4/1993 Shinjo D8/386
 5,256,007 A 10/1993 Allen
 5,449,139 A 9/1995 Herelier
 5,529,451 A * 6/1996 Bruins et al. 411/482
 5,564,232 A 10/1996 Callaway
 5,630,292 A * 5/1997 Heinz et al. 47/46
 5,634,756 A * 6/1997 Losada 411/441
 D380,947 S * 7/1997 Adams D8/1
 5,651,541 A 7/1997 Prime
 D383,054 S * 9/1997 Adams D8/388
 5,755,545 A 5/1998 Banks
 5,788,444 A 8/1998 Losada
 D407,281 S * 3/1999 Antel et al. D8/1
 5,951,202 A 9/1999 Brown
 5,951,208 A 9/1999 Wilson
 D419,431 S * 1/2000 Hollis D8/387
 6,062,789 A * 5/2000 Pope 411/482

6,233,889 B1 5/2001 Hulsey
 D447,025 S * 8/2001 Hughes D8/1
 D452,425 S * 12/2001 Sato et al. D8/386
 D466,379 S * 12/2002 Barbi et al. D8/1
 D466,765 S * 12/2002 Barbi et al. D8/1
 D495,567 S * 9/2004 Gontar D8/1
 D495,932 S * 9/2004 Kopka D8/1
 7,044,688 B2 5/2006 Dever
 7,331,140 B1 * 2/2008 Mason 47/47
 7,384,217 B1 6/2008 Barrett
 D618,088 S * 6/2010 Gaylor D8/391
 D644,094 S * 8/2011 Togami D8/391
 D669,772 S * 10/2012 Fox D8/387
 D679,540 S * 4/2013 Eaton D7/387
 D683,208 S * 5/2013 Nocelo Stelin D8/391
 8,753,042 B1 * 6/2014 Thompson et al. 405/259.1
 2004/0086342 A1 5/2004 Milne
 2010/0021245 A1 1/2010 Li
 2010/0154347 A1 * 6/2010 Jessen 52/698
 2011/0013992 A1 1/2011 Fujii

OTHER PUBLICATIONS

Milliken, Milliken Concrete Cloth, Ground Breaking Material Technology, copyright 2011-2013, retrieved on Jul. 2, 2012, retrieved from <http://concretecloth.milliken.com/Pages/home.aspx>, 2 pages.
 Milliken, Concrete Cloth User Guide, copyright 2011-2013, 11 pages.

* cited by examiner

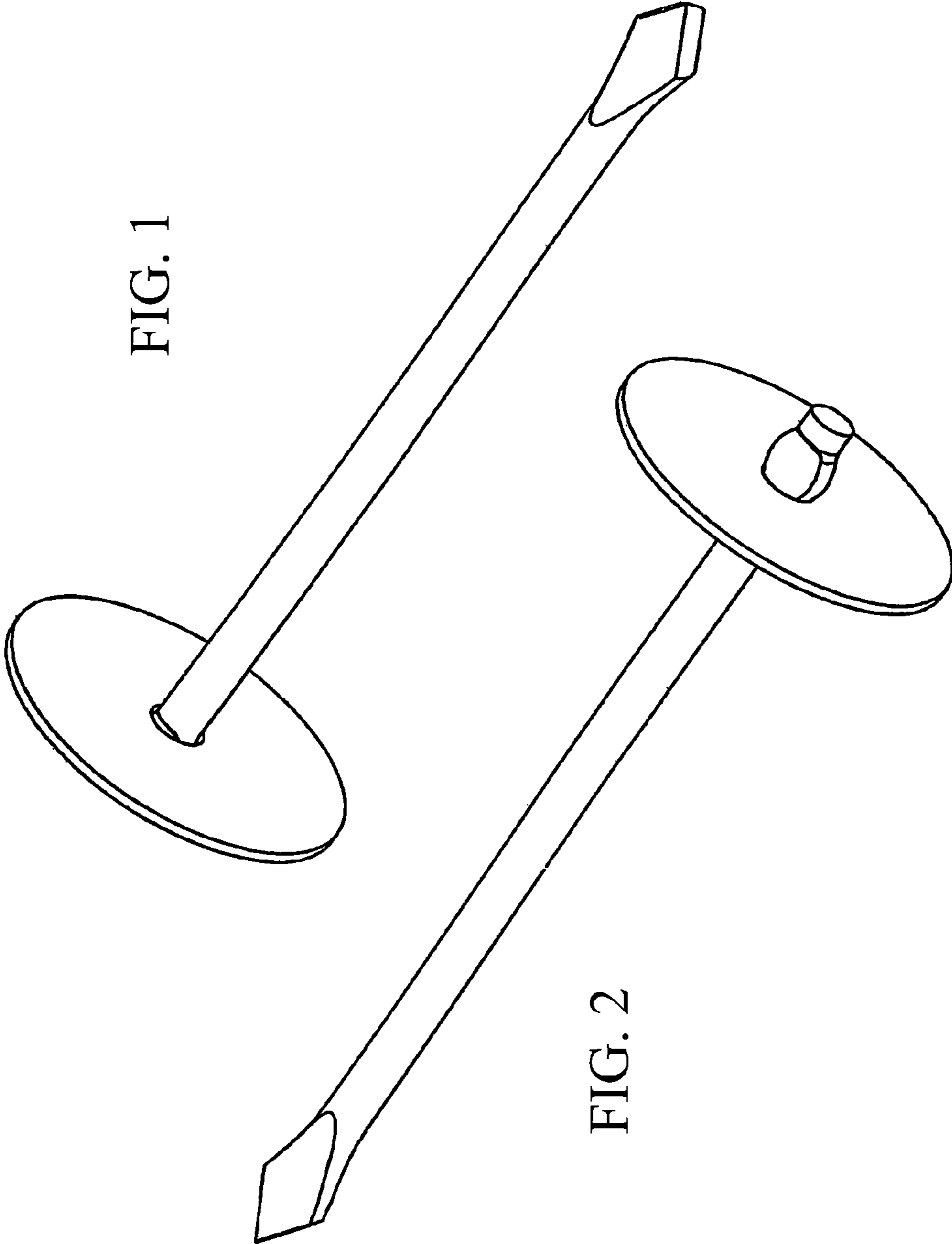

FIG. 1

FIG. 2

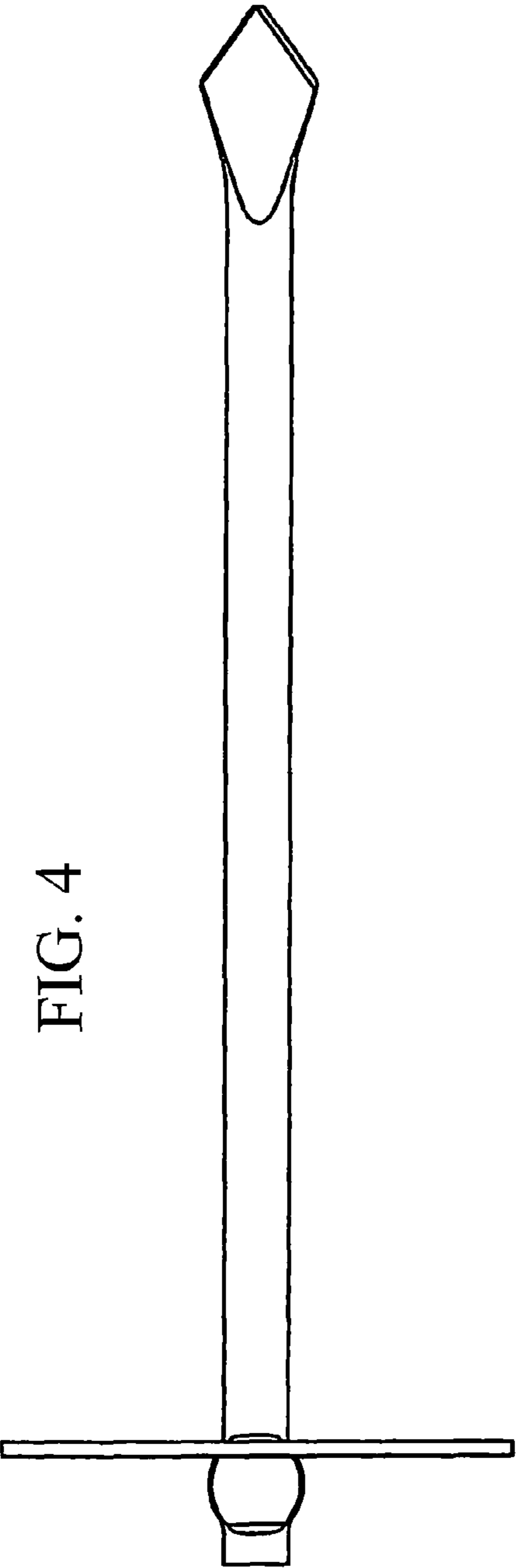
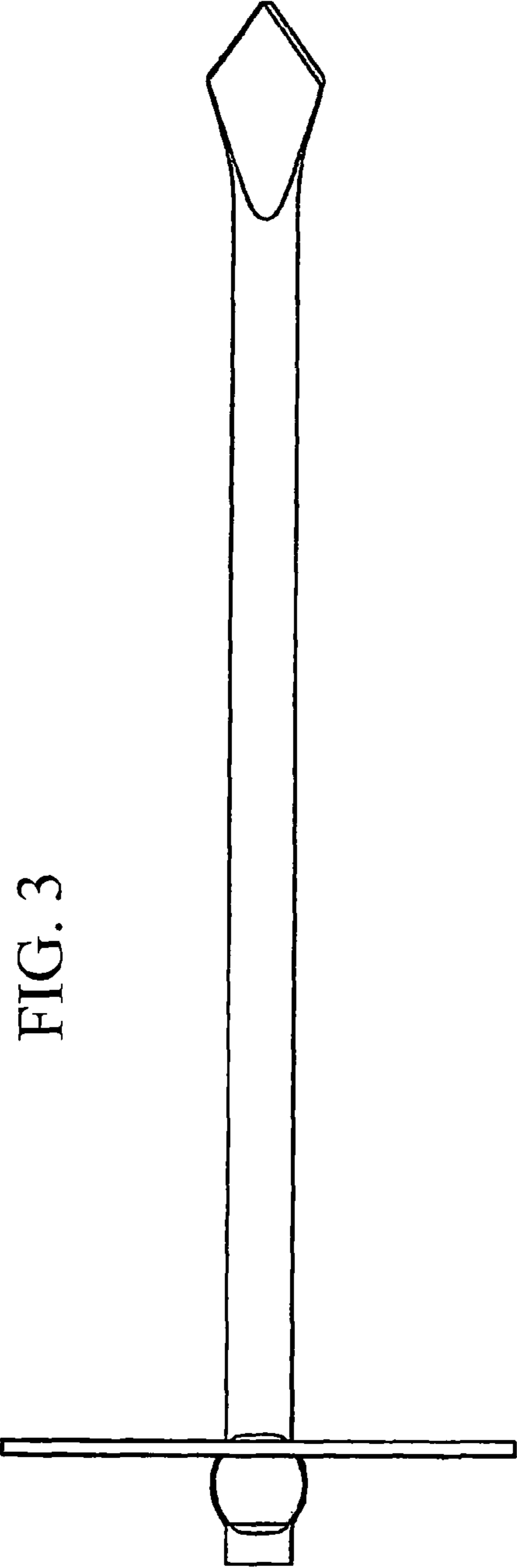

FIG. 5

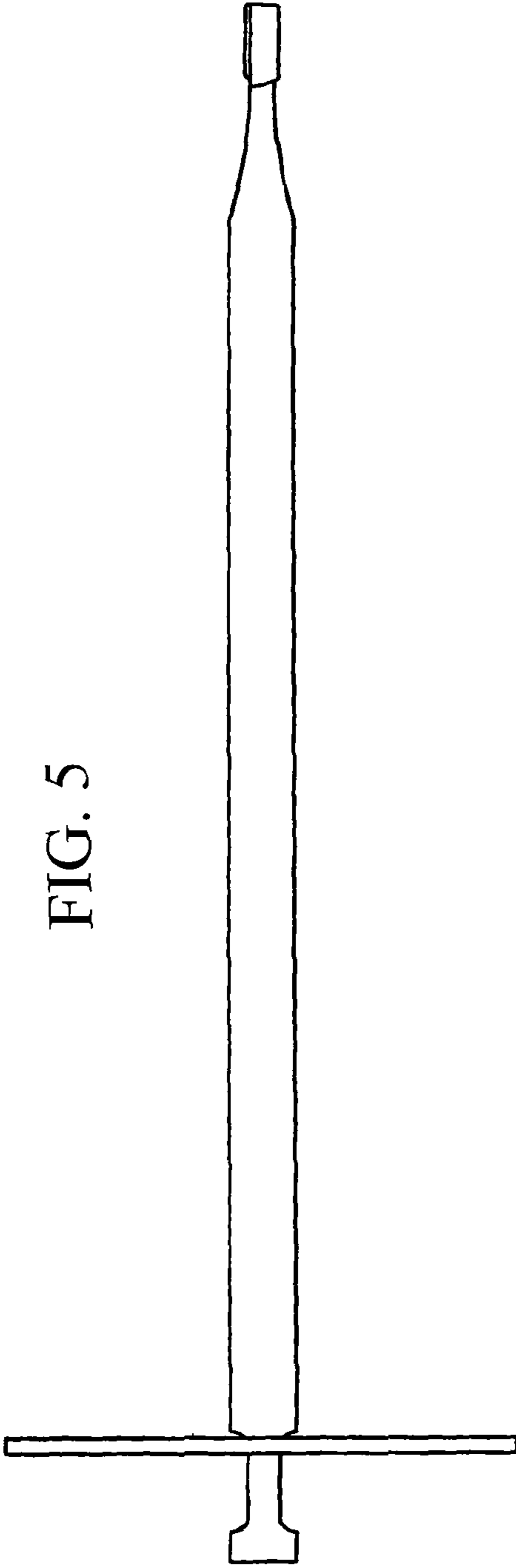

FIG. 6

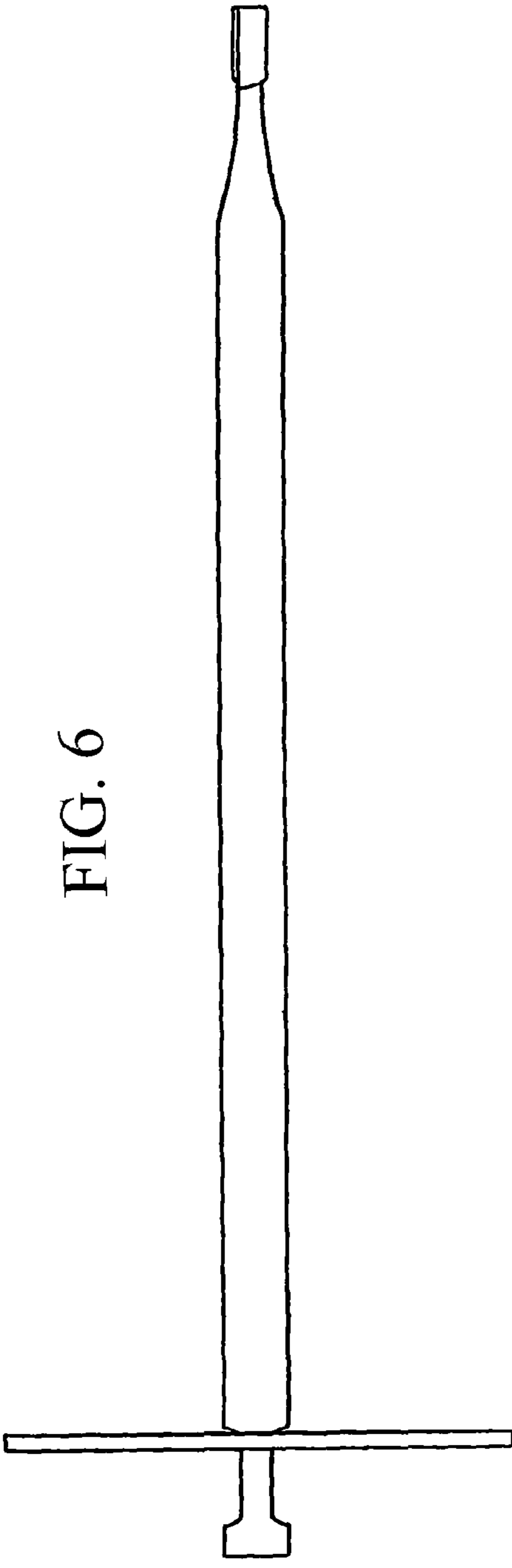

FIG. 8

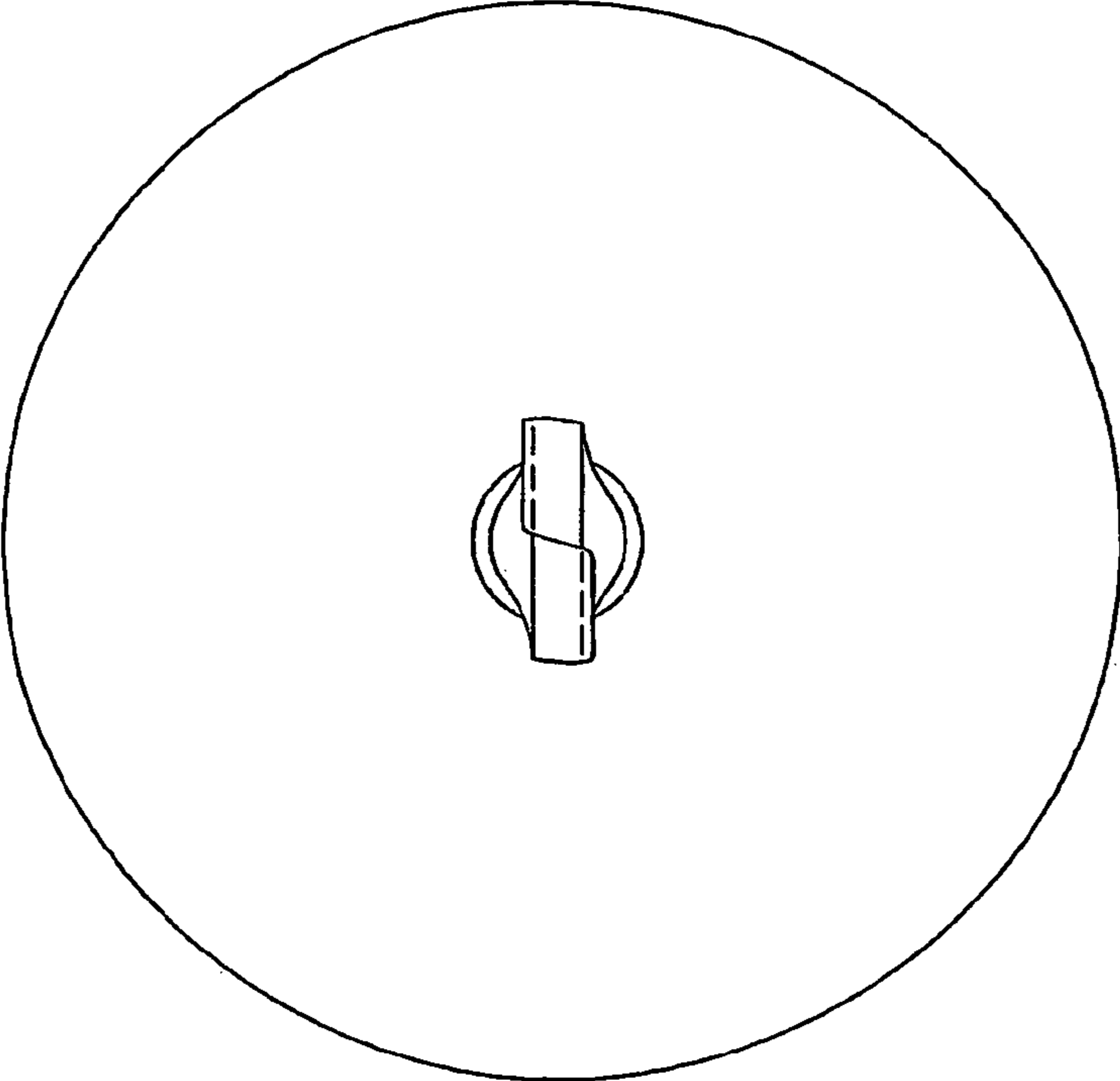

FIG. 7

