



US00D719783S

(12) **United States Design Patent**
Eubank et al.

(10) **Patent No.:** **US D719,783 S**

(45) **Date of Patent:** **** Dec. 23, 2014**

(54) **HOLSTER MUG**

(71) Applicants: **Robert Eubank**, San Diego, CA (US);
Jack Graham, Phoenix, AZ (US)

(72) Inventors: **Robert Eubank**, San Diego, CA (US);
Jack Graham, Phoenix, AZ (US)

(73) Assignee: **American Legacy Products, Inc.**, Vista,
CA (US)

(**) Term: **14 Years**

(21) Appl. No.: **29/479,420**

(22) Filed: **Jan. 15, 2014**

(51) **LOC (10) Cl.** **07-01**

(52) **U.S. Cl.**
USPC **D7/515**

(58) **Field of Classification Search**
USPC D7/536, 533, 515, 514, 606; D9/680;
446/220; 215/386, 396
See application file for complete search history.

(56) **References Cited**

U.S. PATENT DOCUMENTS

D18,718 S *	11/1888	Bloomingtondale	D9/680
D115,532 S *	7/1939	Stough	D9/680
D171,287 S *	1/1954	Alvarez	D7/623
2,749,727 A *	6/1956	Fabro	215/236
D207,408 S *	4/1967	Levin et al.	D7/515

D211,105 S *	5/1968	Swenson	D7/515
D300,402 S *	3/1989	Tardel et al.	D7/515
D303,195 S *	9/1989	Devine	D7/515
D349,626 S *	8/1994	Rigsby	D7/515
D368,408 S *	4/1996	Ratcliff	D7/517
D505,298 S *	5/2005	Holt	D7/515
D617,147 S *	6/2010	White	D7/515
8,257,134 B2 *	9/2012	Zuloff	446/220
D697,765 S *	1/2014	Wampold	D7/606
D698,601 S *	2/2014	Harris	D7/515

* cited by examiner

Primary Examiner — Marianne Pandozzi

(74) *Attorney, Agent, or Firm* — Coastal Patent Law Group,
P.C.; Joshua S. Schoonover

(57) **CLAIM**

The ornamental design for a holster mug, as shown and described.

DESCRIPTION

FIG. 1 is a front perspective view of the holster mug showing a top, front, and left side thereof;
FIG. 2 is a rear perspective view of the holster mug showing a top, rear, and right side thereof;
FIG. 3 is front view of the holster mug;
FIG. 4 is a rear view of the holster mug;
FIG. 5 is a left side of the holster mug;
FIG. 6 is a right side of the holster mug;
FIG. 7 is a top view of the holster mug; and,
FIG. 8 is a bottom view of the holster mug.

1 Claim, 7 Drawing Sheets

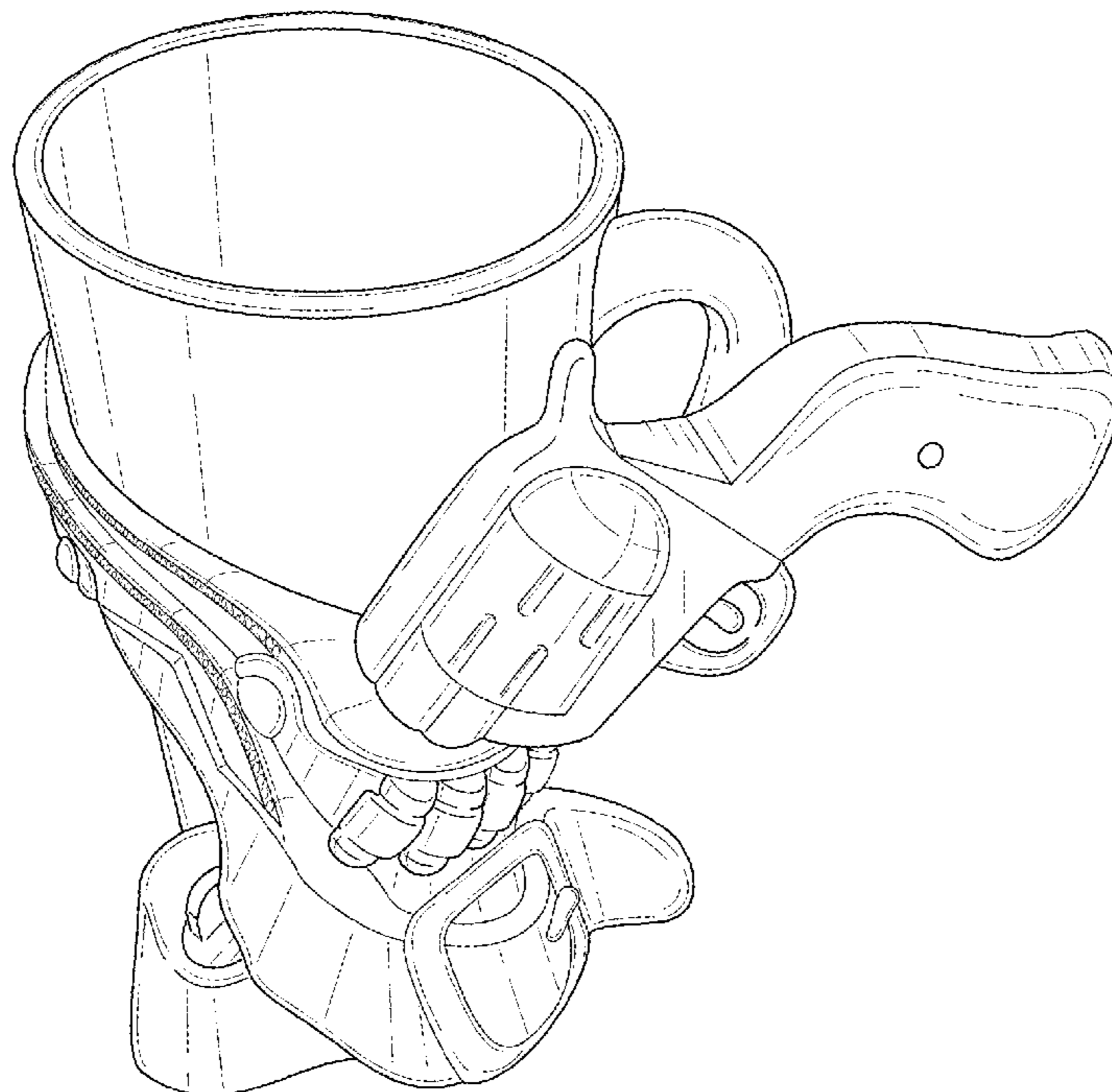

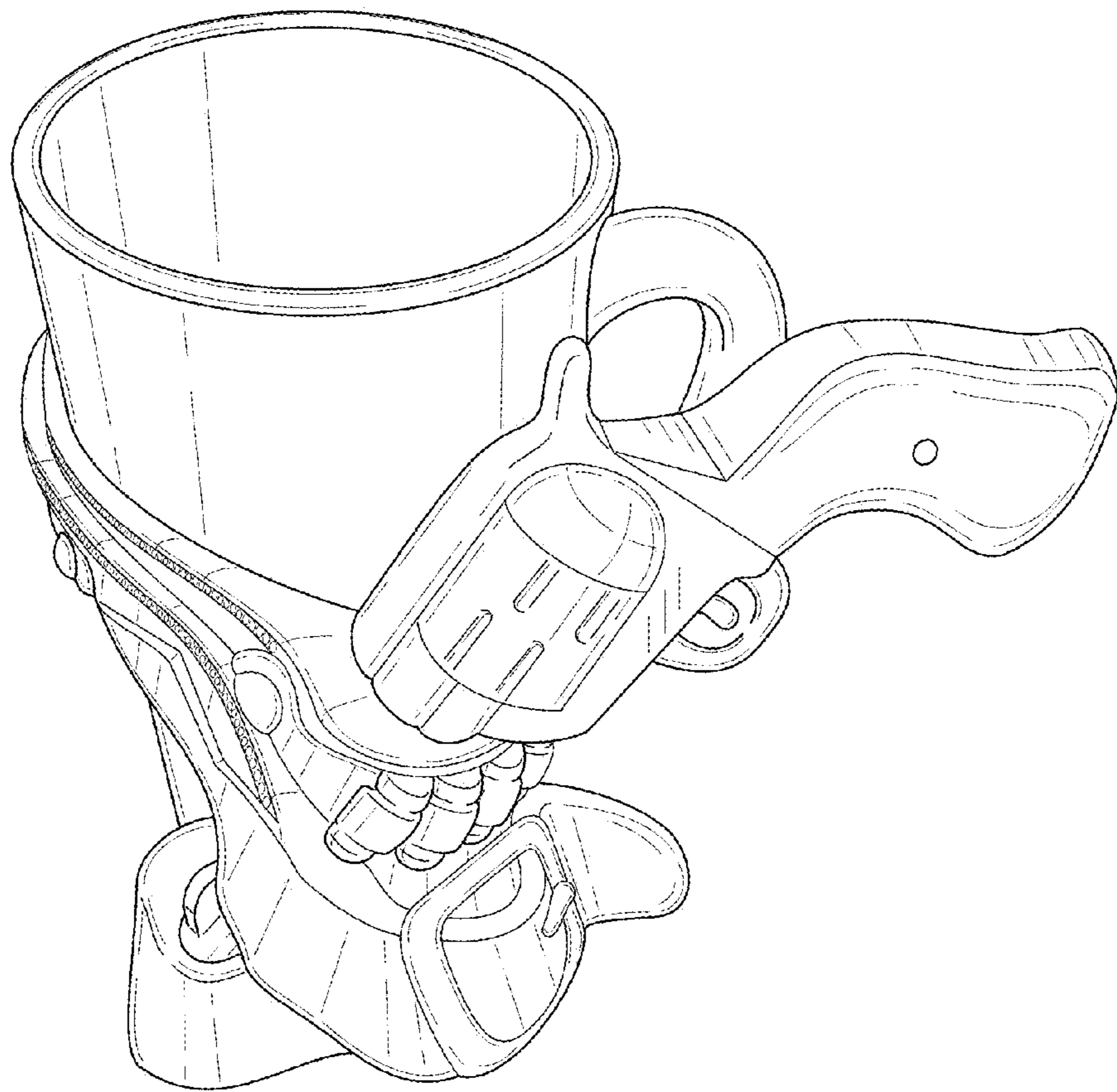

FIG. 1

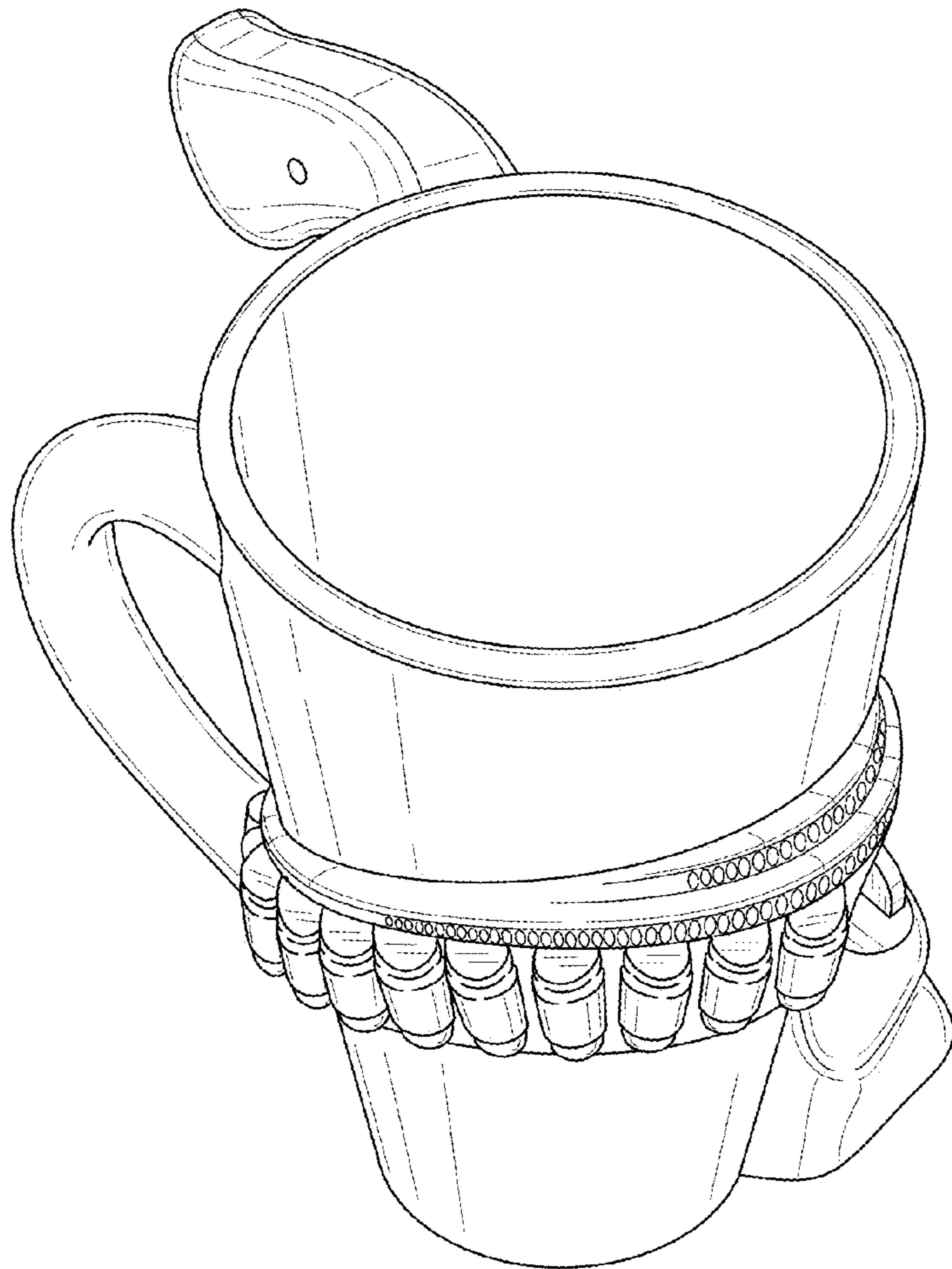

FIG. 2

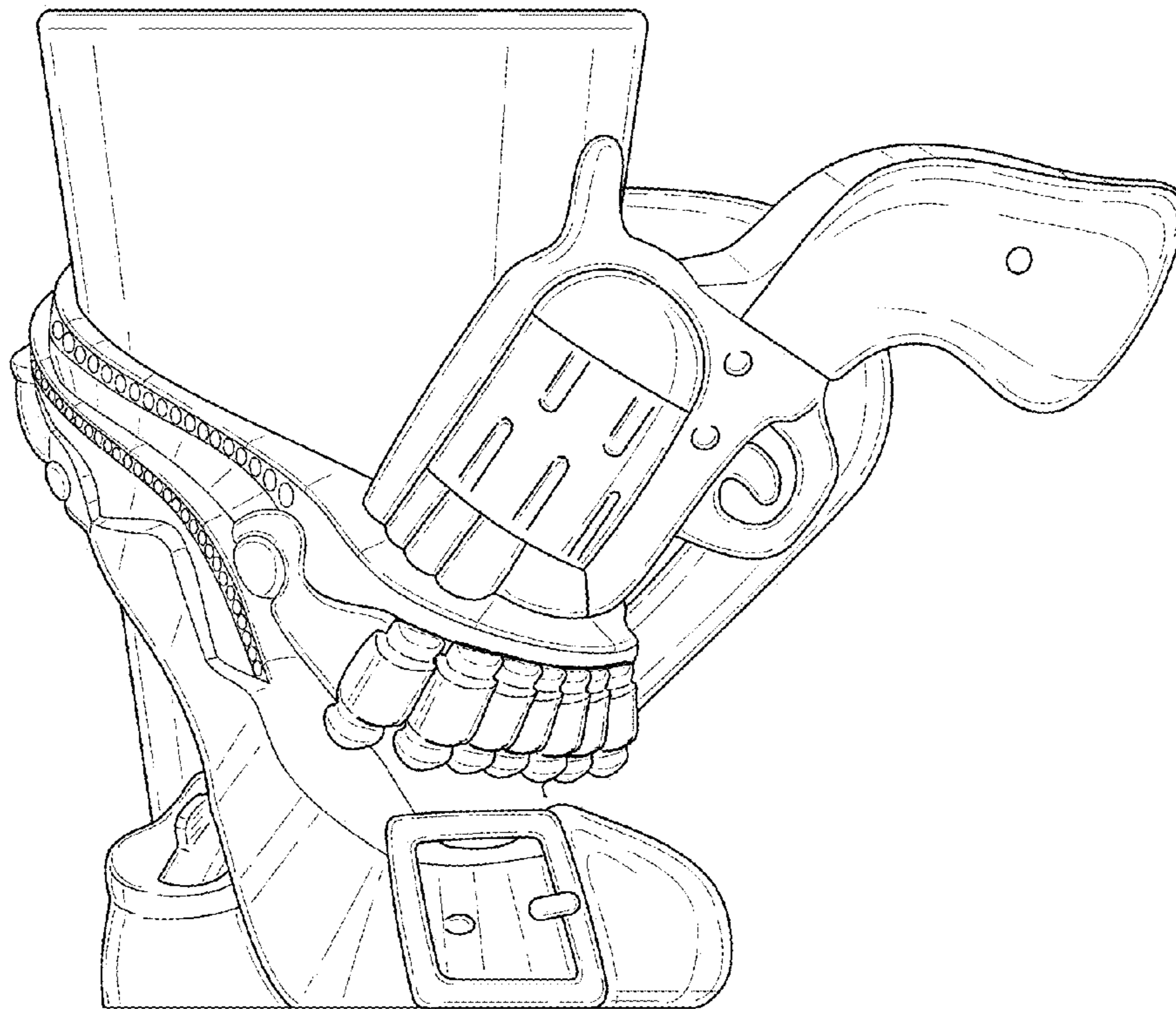

FIG. 3

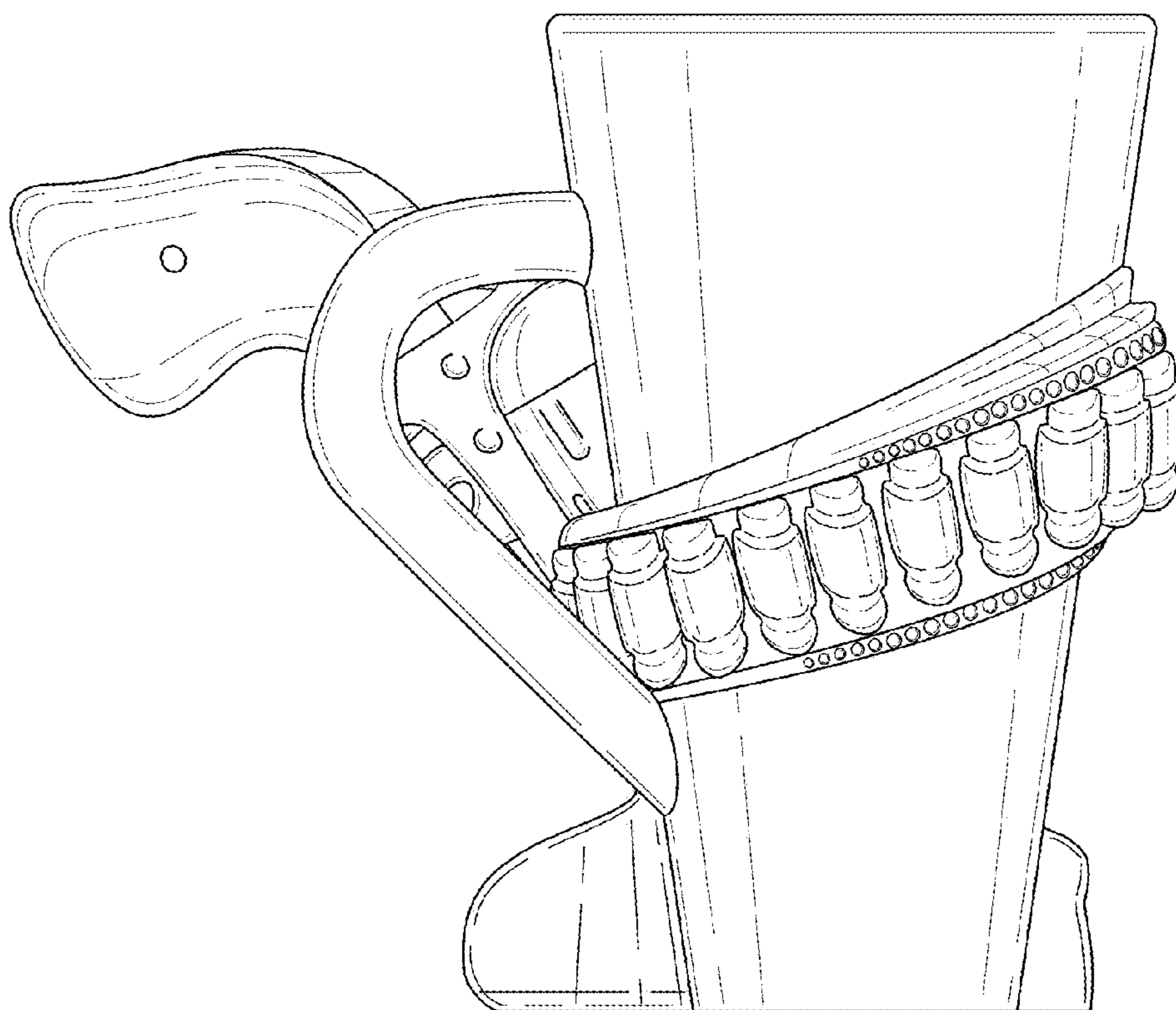

FIG. 4

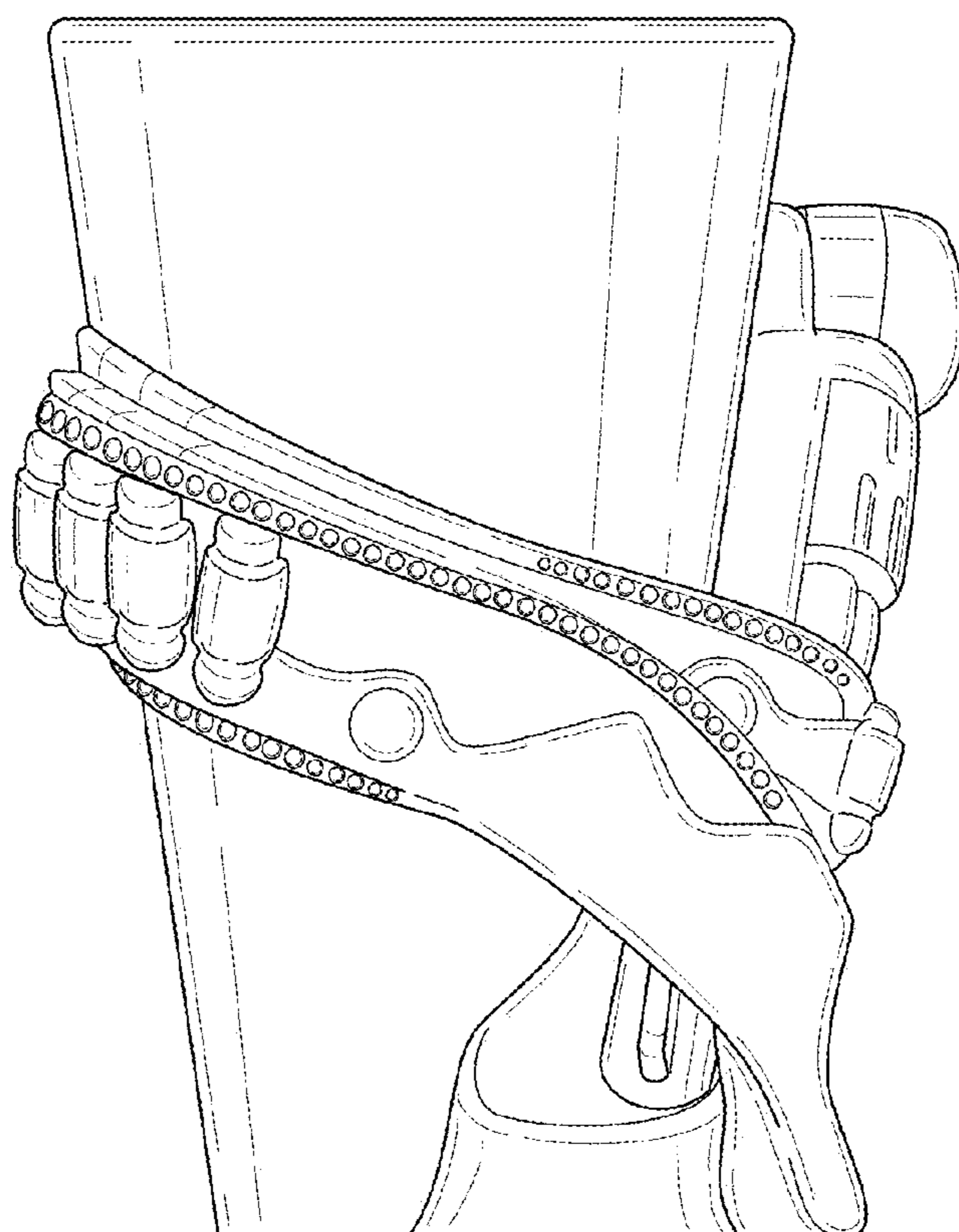

FIG. 5

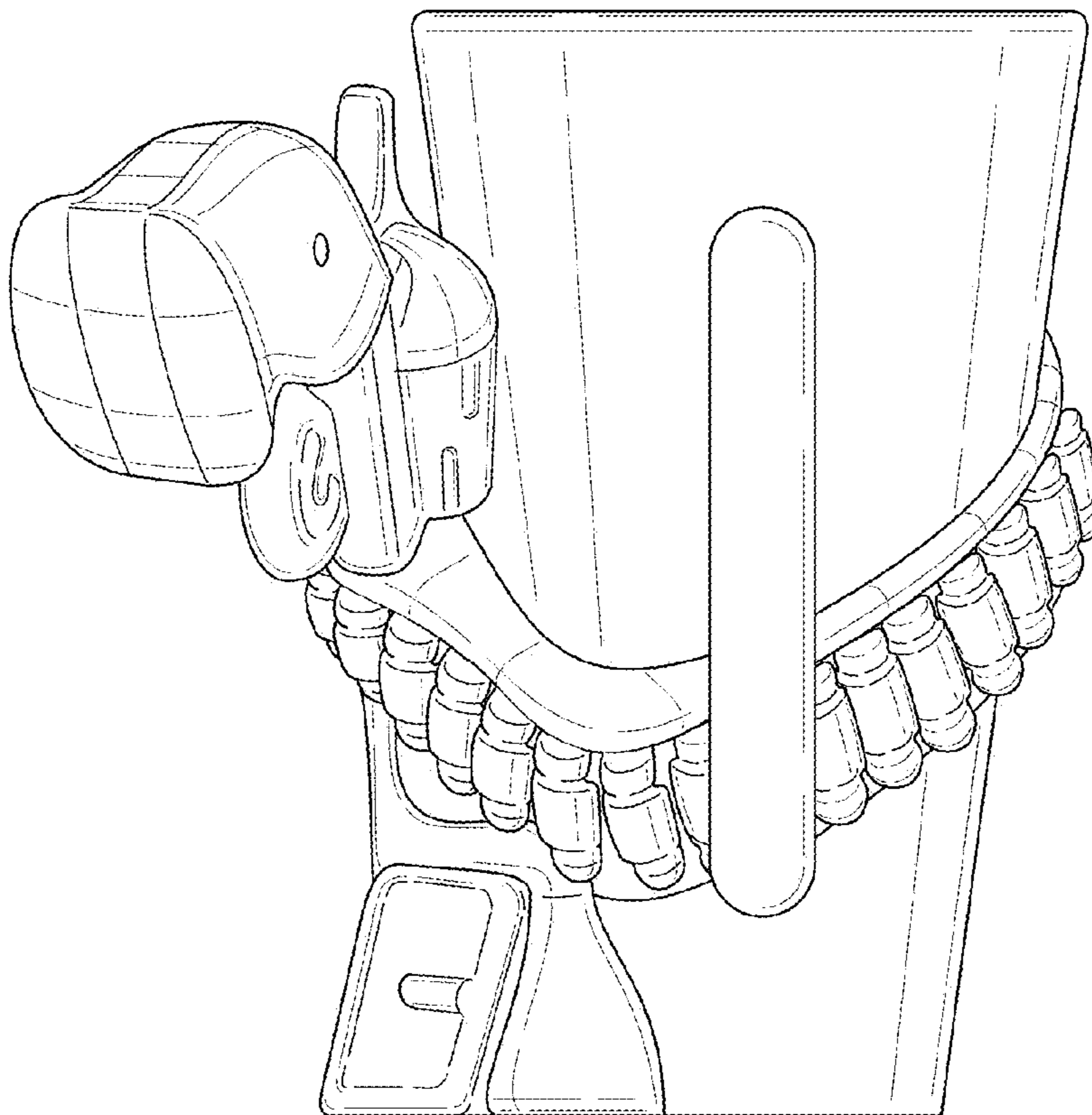

FIG. 6

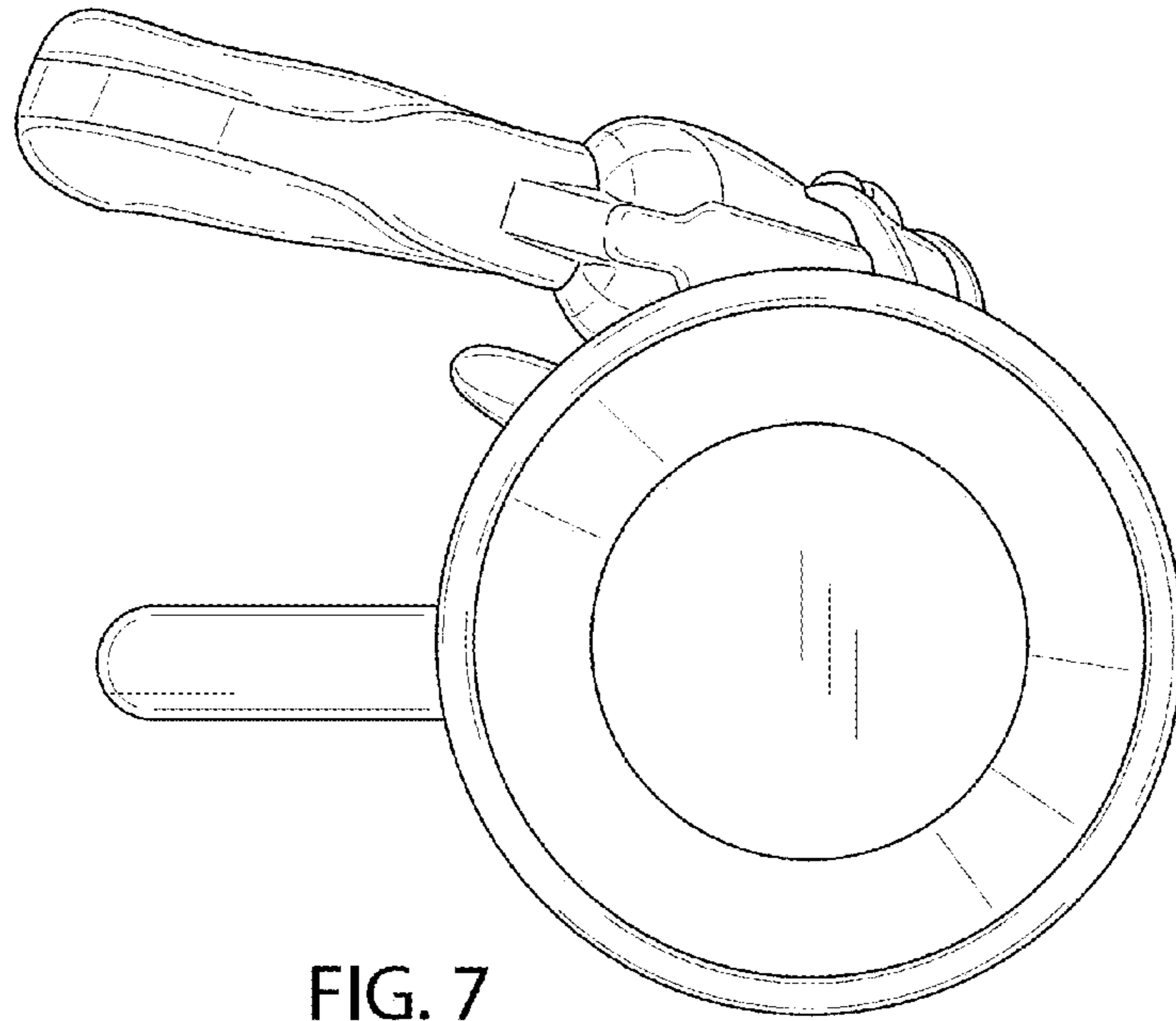

FIG. 7

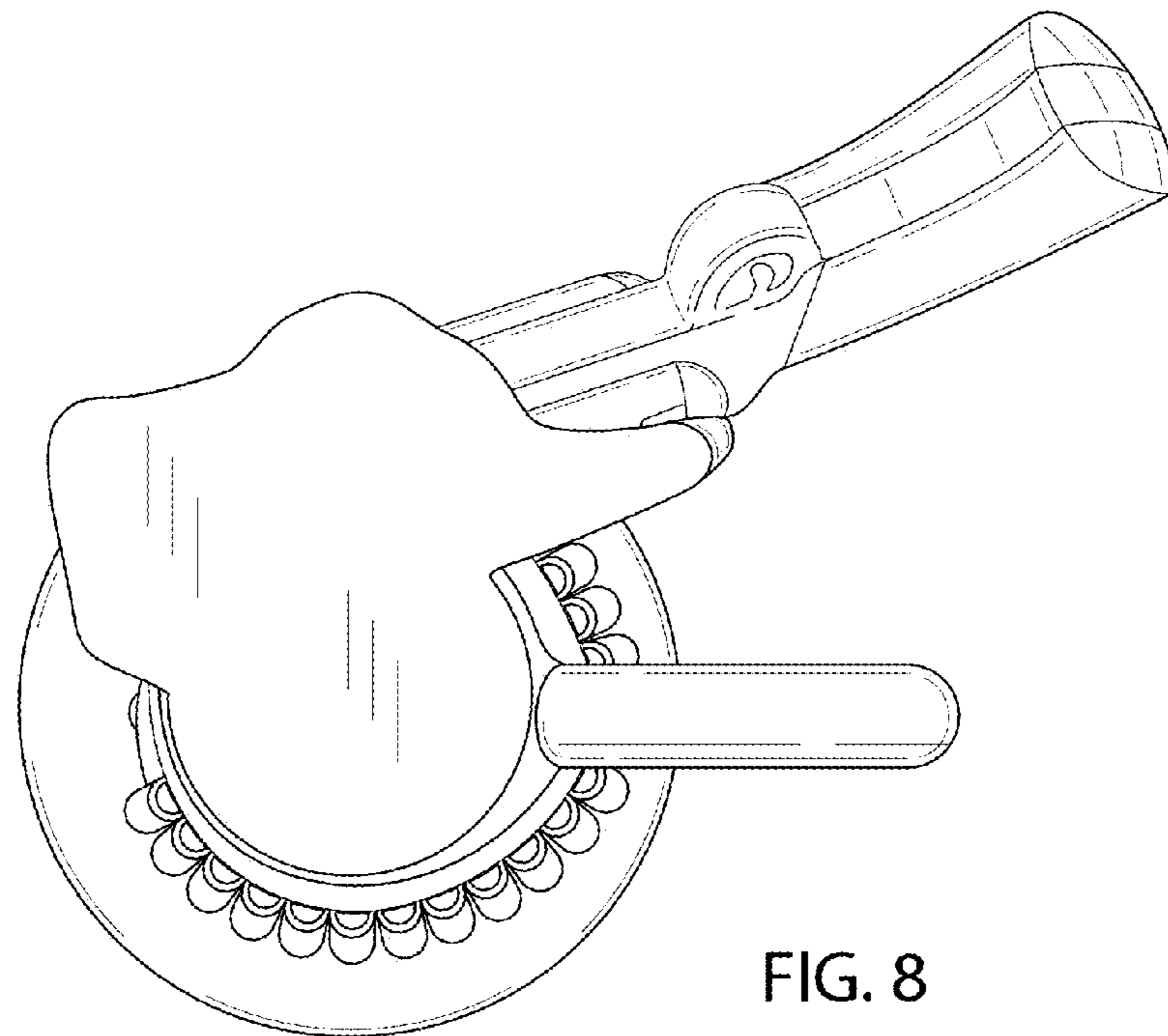

FIG. 8