



US00D719760S

(12) **United States Design Patent**
Cute

(10) **Patent No.:** **US D719,760 S**

(45) **Date of Patent:** **** Dec. 23, 2014**

- (54) **POT HOLDER AND FLAG STAND**
- (71) Applicant: **Sun Hill Industries, Inc.**, Fairfield, CA (US)
- (72) Inventor: **Joseph E. Cute**, Geneva, IL (US)
- (73) Assignee: **Sun Hill Industries, Inc.**, Fairfield, CT (US)
- (**) Term: **14 Years**
- (21) Appl. No.: **29/467,317**
- (22) Filed: **Sep. 18, 2013**
- (51) **LOC (10) Cl.** **11-02**
- (52) **U.S. Cl.**
USPC **D6/403**
- (58) **Field of Classification Search**
USPC D6/403-405, 556-558, 681.1;
D11/143-156, 164, 182; D26/19-11,
D26/55, 87; 47/17, 18, 32.7, 33, 39, 41.01,
47/41.11-41.15, 65, 65.5, 66.1, 66.6, 66.7,
47/67-71
See application file for complete search history.

D275,245 S *	8/1984	Pack	D6/462
D299,088 S *	12/1988	Monza	D6/403
D387,216 S *	12/1997	Stone	D6/405
D429,921 S *	8/2000	Allanson	D6/458
D434,247 S *	11/2000	Rosenberg	D6/403
D632,505 S *	2/2011	Yeh	D6/403
D658,906 S *	5/2012	Cute	D6/403
8,172,187 B2 *	5/2012	Felknor et al.	248/188
D692,253 S *	10/2013	Cute	D6/404
D694,547 S *	12/2013	Cute	D6/403
D698,180 S *	1/2014	Cute	D6/403
D698,565 S *	2/2014	Cute	D6/403
D698,566 S *	2/2014	Cute	D6/403
D707,464 S *	6/2014	Cute	D6/403
2012/0227317 A1 *	9/2012	Yeh	47/39

* cited by examiner

Primary Examiner — Elizabeth Albert

(74) *Attorney, Agent, or Firm* — Riverside Law LLP

(57) **CLAIM**

I claim the ornamental design for a pot holder and flag stand, as shown and described.

DESCRIPTION

FIG. 1 is a perspective view of a pot holder and flag stand;
 FIG. 2 is a front view thereof;
 FIG. 3 is a rear view thereof;
 FIG. 4 is a right side view thereof;
 FIG. 5 is a left side view thereof;
 FIG. 6 is a top view thereof;
 FIG. 7 is a bottom view thereof; and,
 FIG. 8 is another perspective view of a pot holder and flag stand.

The broken lines are included to show portions of the pot holder and flag stand that form no part of the claimed design.

1 Claim, 7 Drawing Sheets

(56) **References Cited**

U.S. PATENT DOCUMENTS

D36,086 S *	9/1902	Olsen	D6/403
D63,046 S *	9/1923	Stuck	D6/403
1,958,716 A *	5/1934	Roach et al.	248/156
2,001,646 A *	5/1935	Abitsch	248/527
D147,902 S *	11/1947	Gray	D6/498
D186,517 S *	11/1959	Walsh	D6/411
4,111,471 A *	9/1978	Hanley	289/16.5
D260,338 S *	8/1981	Savage	D6/410

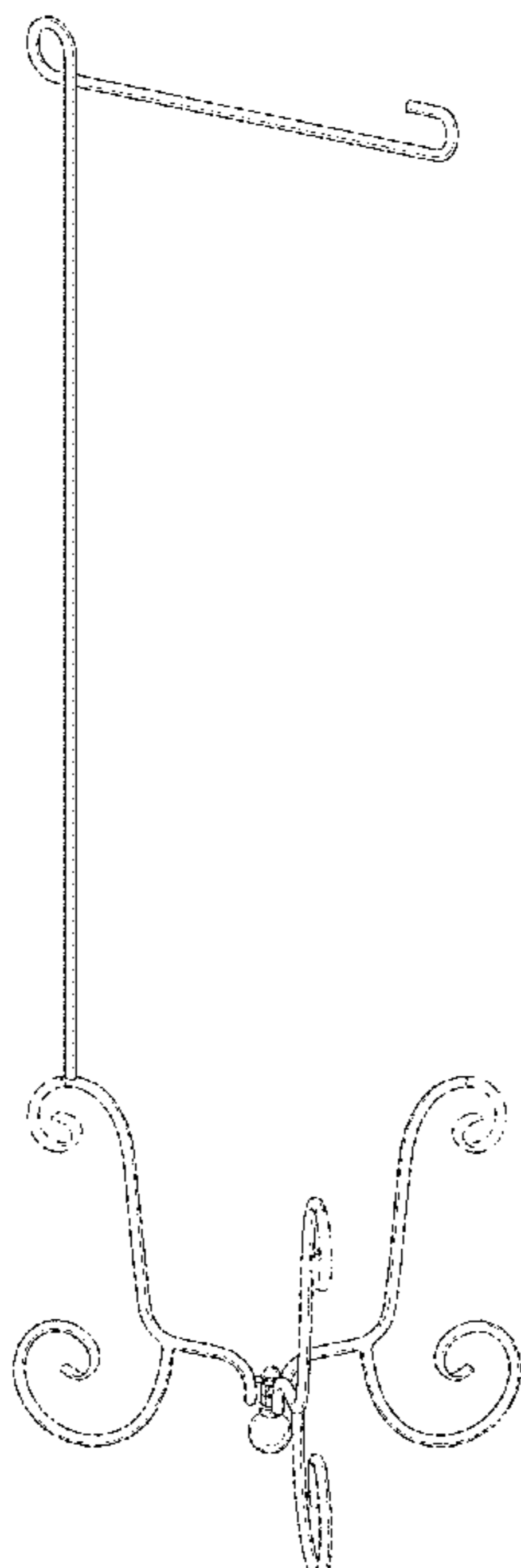

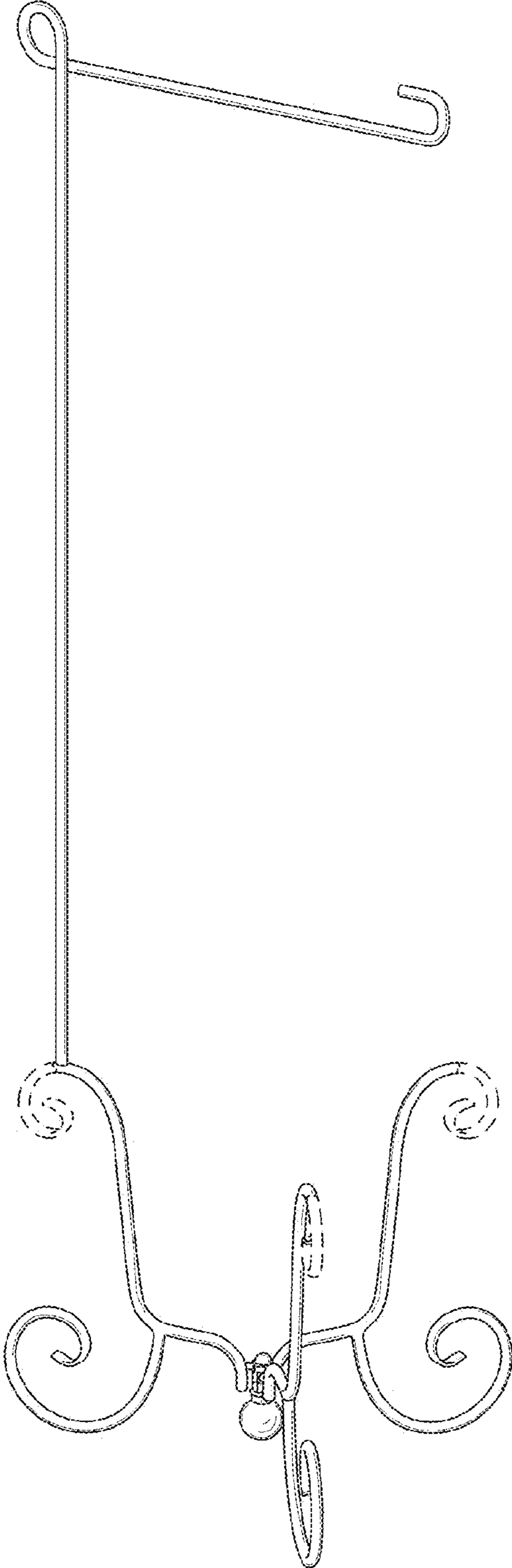

FIG. 1

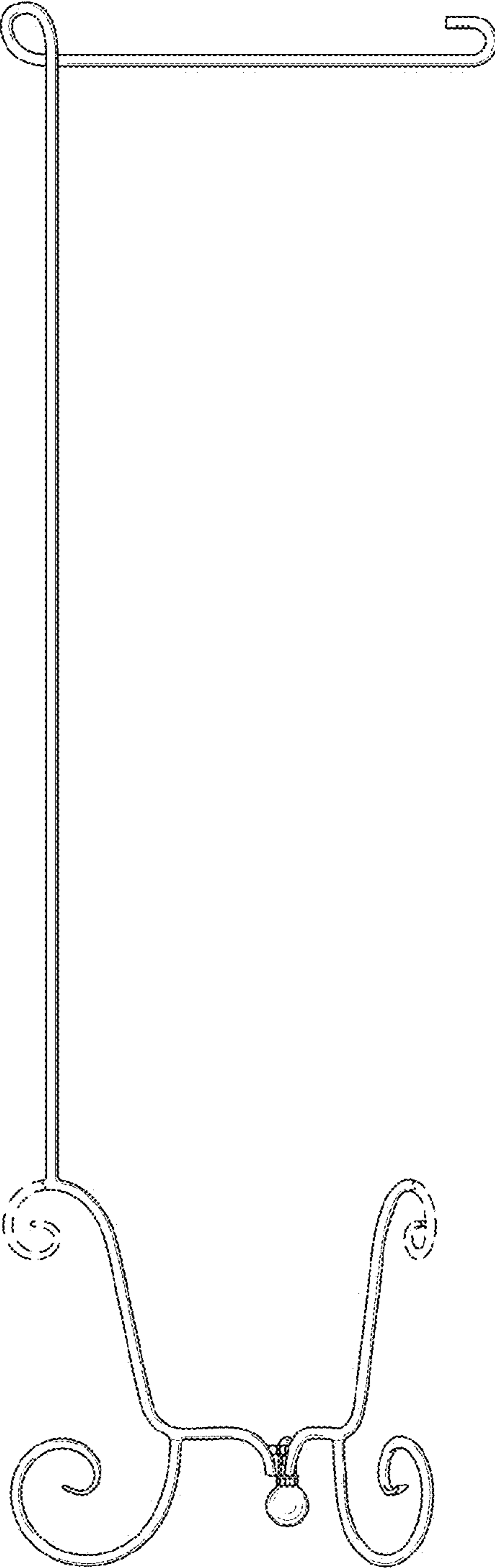

FIG. 2

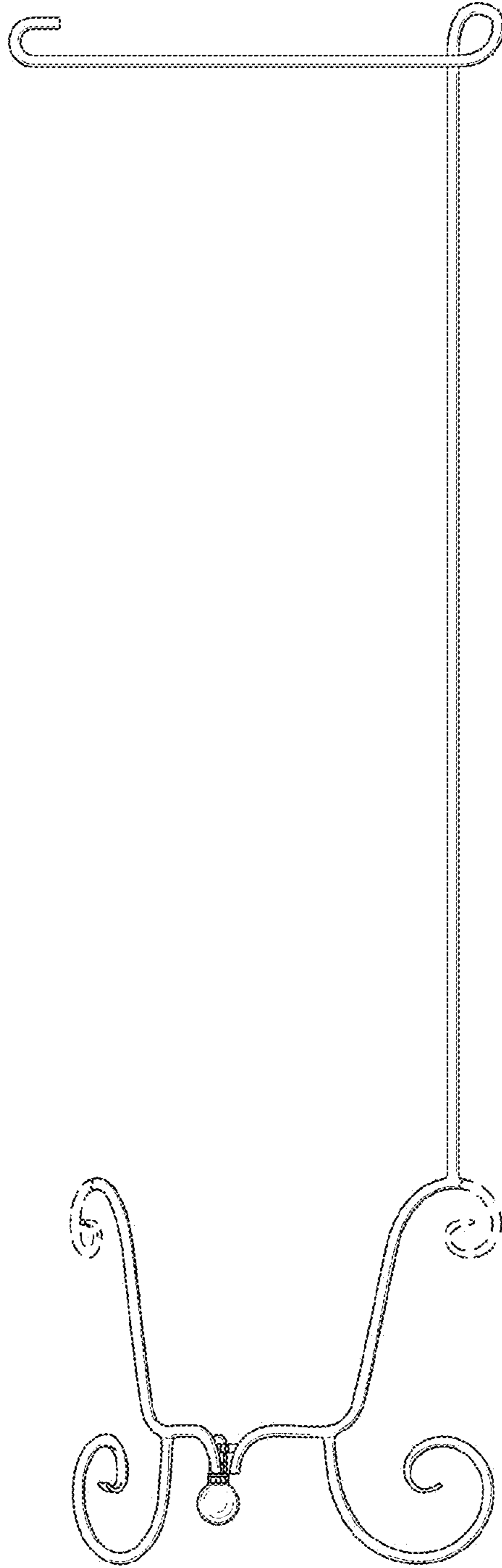

FIG. 3

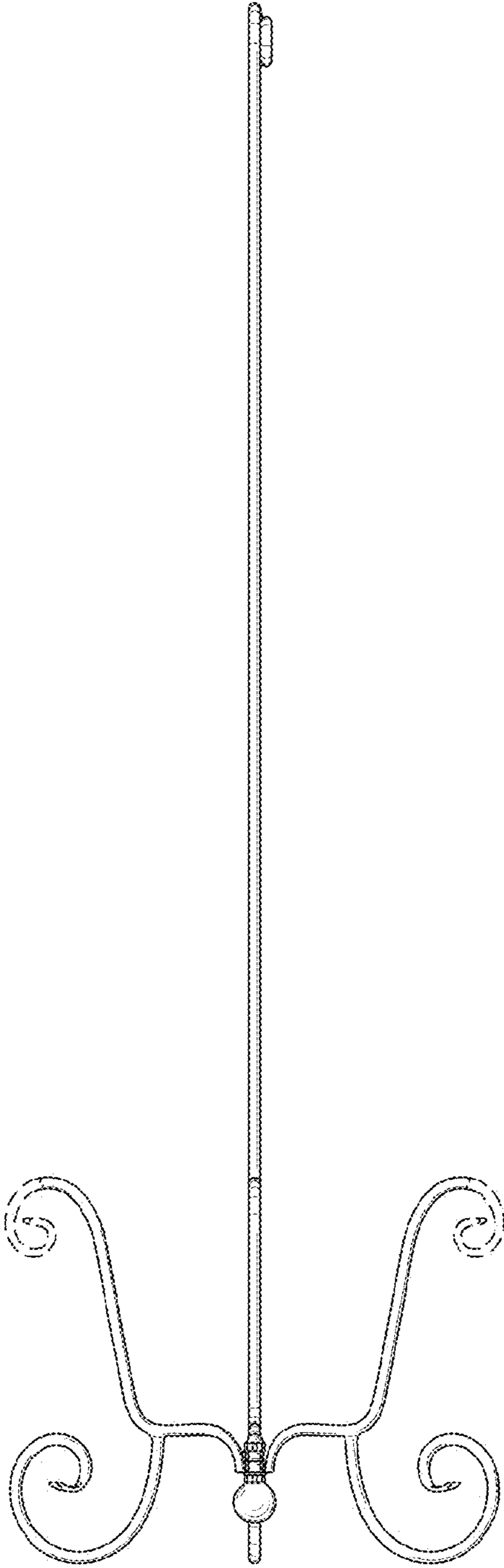

FIG. 4

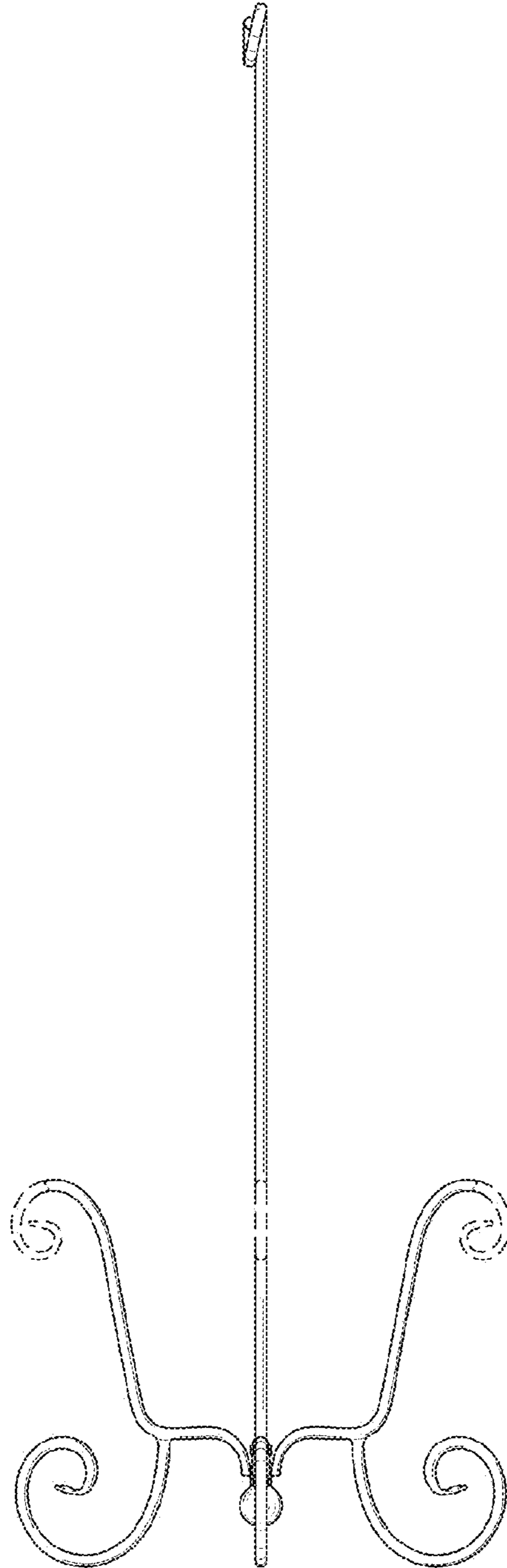

FIG. 5

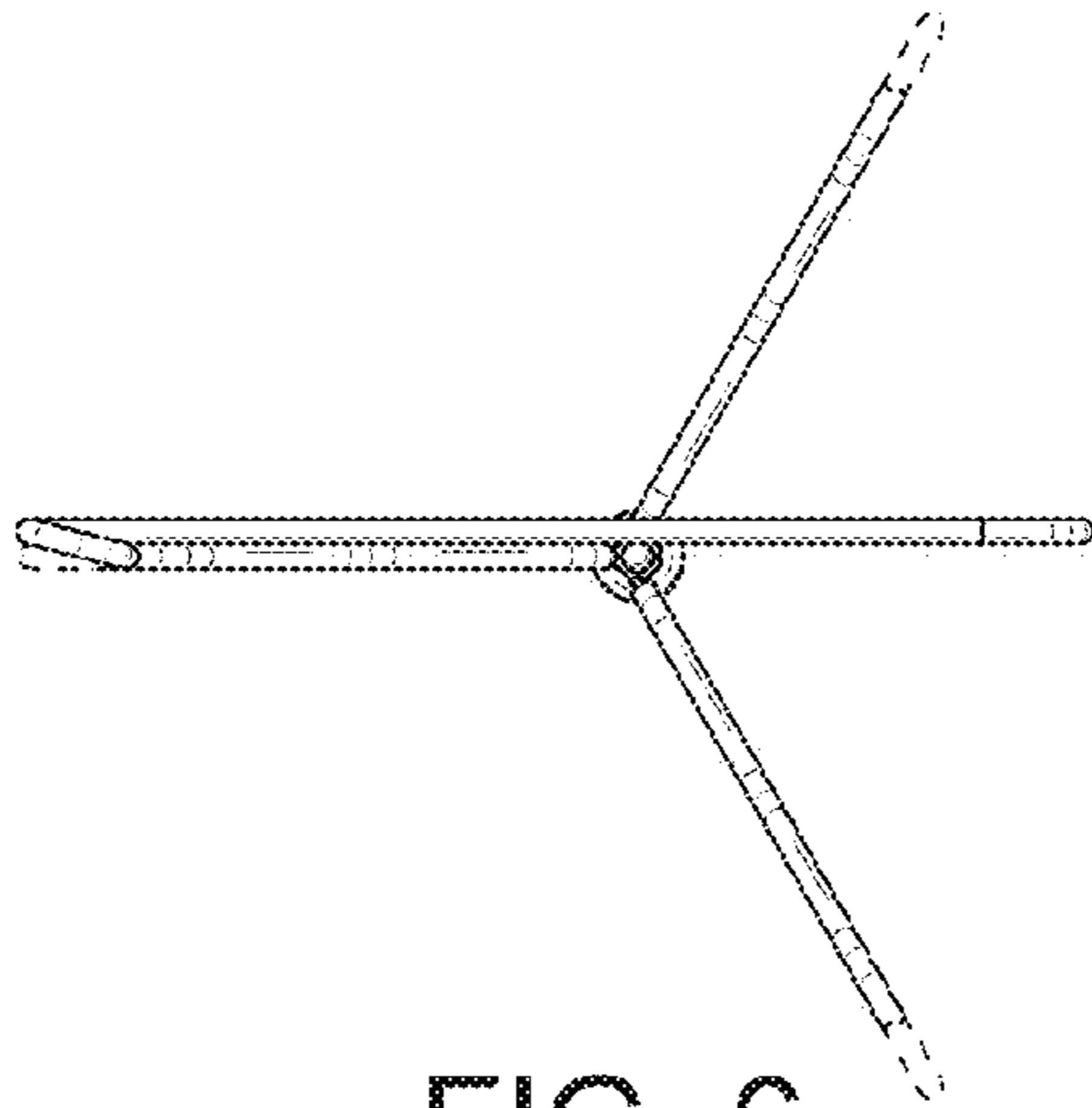

FIG. 6

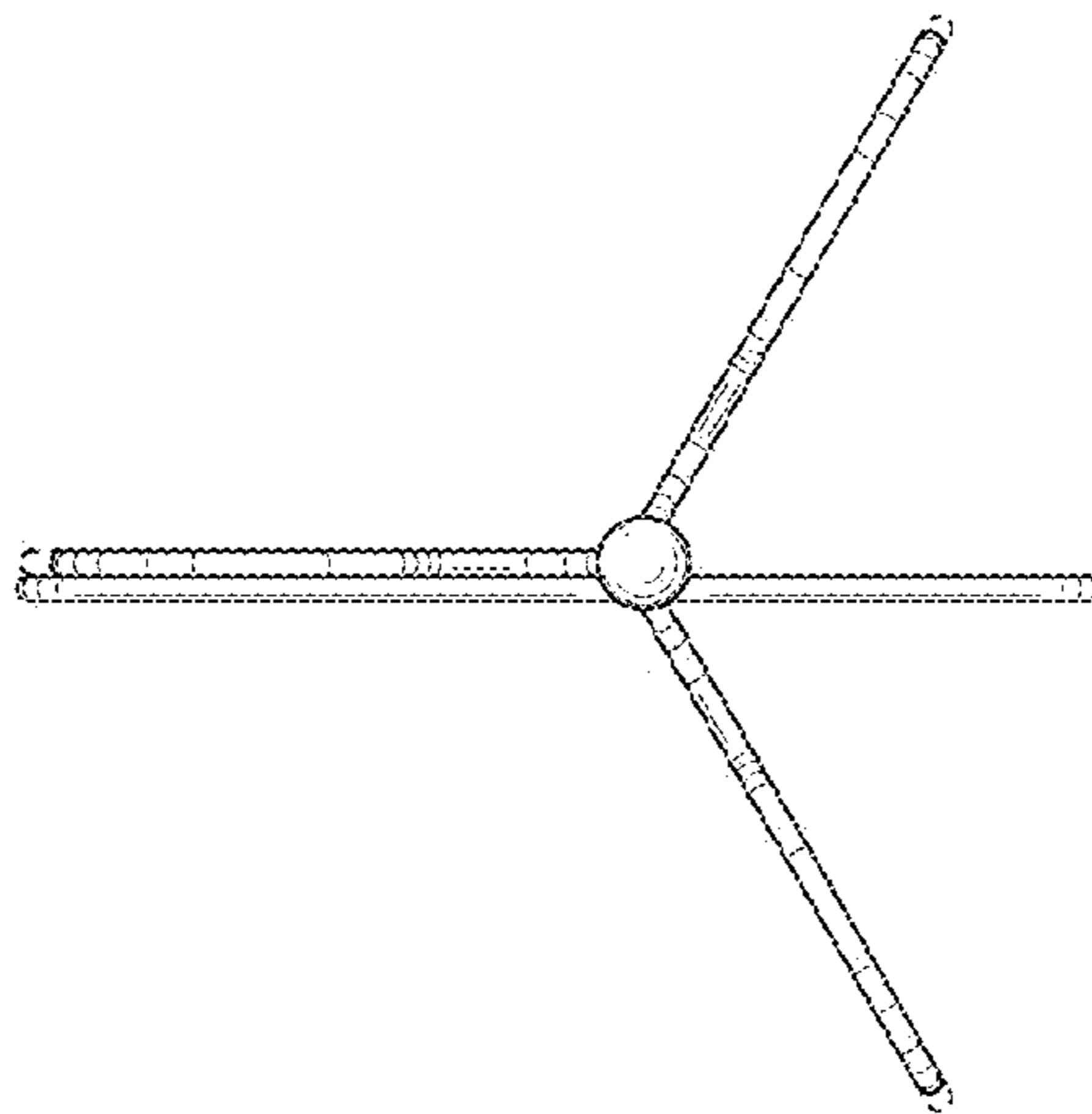

FIG. 7

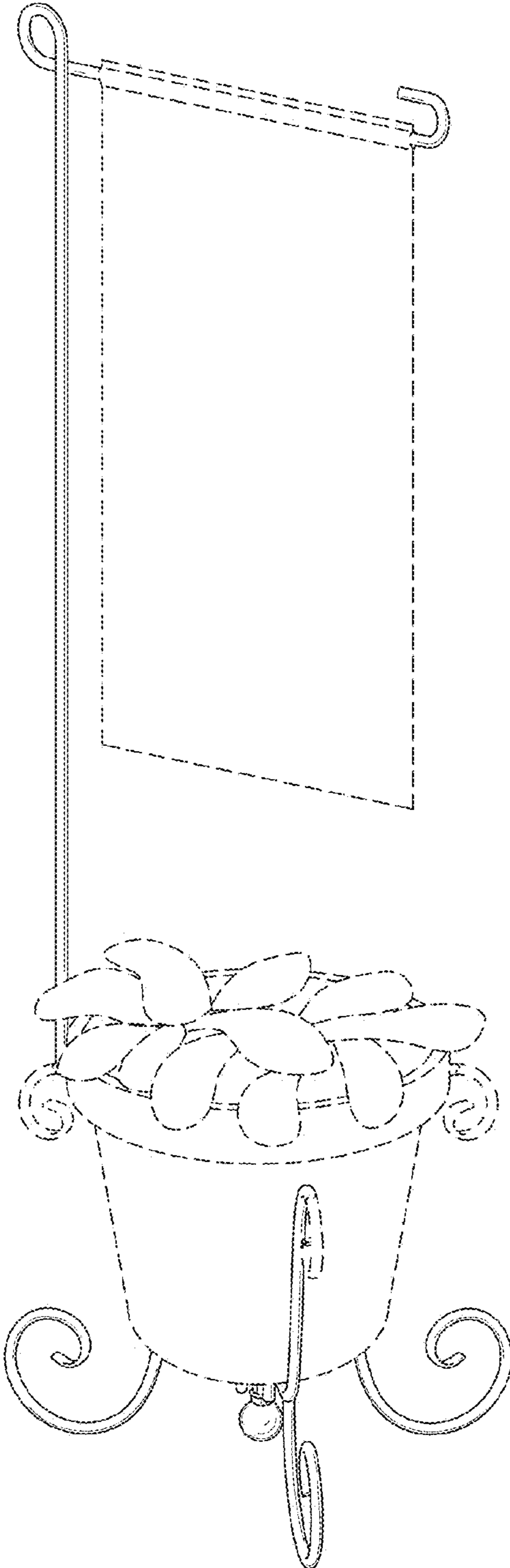

FIG. 8