



(12) **United States Design Patent**
Lim

(10) **Patent No.:** **US D719,655 S**
(45) **Date of Patent:** **** Dec. 16, 2014**

(54) **HEAD OF A DENTAL ELEVATOR**

(71) Applicant: **Dental USA, Inc.**, McHenry, IL (US)

(72) Inventor: **Jang H. Lim**, McHenry, IL (US)

(73) Assignee: **Dental USA, Inc.**, McHenry, IL (US)

(**) Term: **14 Years**

(21) Appl. No.: **29/462,189**

(22) Filed: **Jul. 31, 2013**

Related U.S. Application Data

(63) Continuation of application No. 29/431,804, filed on Sep. 11, 2012, now Pat. No. Des. 690,010.

(51) **LOC (10) Cl.** **24-02**

(52) **U.S. Cl.**
USPC **D24/153**

(58) **Field of Classification Search**
USPC D24/133, 143, 146-147, 148, 152-154,
D24/176; D8/52, 54-56, 58; 7/125-128;
81/300, 302, 305-306, 342, 356, 382,
81/385, 427.5, 424; 433/4, 141, 152,
433/159-160

See application file for complete search history.

(56) **References Cited**

U.S. PATENT DOCUMENTS

491,932 A * 2/1893 Whitlock 433/159
991,313 A * 5/1911 Hull 433/159

(Continued)

Primary Examiner — Wan Laymon

(74) *Attorney, Agent, or Firm* — Bishop Diehl & Lee, Ltd.

(57) **CLAIM**

The ornamental design for the head of a dental elevator, as shown and described.

DESCRIPTION

FIG. 1 is an elevated isometric view of a first embodiment of a head of a dental elevator showing the new design;

FIG. 2 is a bottom isometric view of the head of a dental elevator as shown in FIG. 1;

FIG. 3 is a top isometric view of the head of a dental elevator in an open configuration;

FIG. 4 is a bottom isometric view of the head of a dental elevator shown in FIG. 3;

FIG. 5 is a top view of the head of a dental elevator in a closed configuration;

FIG. 6 is a bottom view of the head of a dental elevator as shown in FIG. 1;

FIG. 7 is a right side view of the head of a dental elevator as shown in FIG. 1;

FIG. 8 is a left side view of the head of a dental elevator as shown in FIG. 1;

FIG. 9 is a front side view of the head of a dental elevator as shown in FIG. 1;

FIG. 10 is a rear side view of the head of a dental elevator as shown in FIG. 1;

FIG. 11 is an elevated isometric view of a second embodiment of a head of a dental elevator showing the new design;

FIG. 12 is a bottom isometric view of the head of a dental elevator as shown in FIG. 11;

FIG. 13 is a top isometric view of the head of a dental elevator in an open configuration;

FIG. 14 is a bottom isometric view of the head of a dental elevator shown in FIG. 13;

FIG. 15 is a top view of the head of a dental elevator in a closed configuration;

FIG. 16 is a bottom view of the head of a dental elevator as shown in FIG. 11;

FIG. 17 is a right side view of the head of a dental elevator as shown in FIG. 11;

FIG. 18 is a left side view of the head of a dental elevator as shown in FIG. 11;

FIG. 19 is a front side view of the head of a dental elevator as shown in FIG. 11; and,

FIG. 20 is a rear side view of the head of a dental elevator as shown in FIG. 11.

The broken lines shown in the figures represent portions of the head of a dental elevator that form no part of the claimed design.

1 Claim, 8 Drawing Sheets

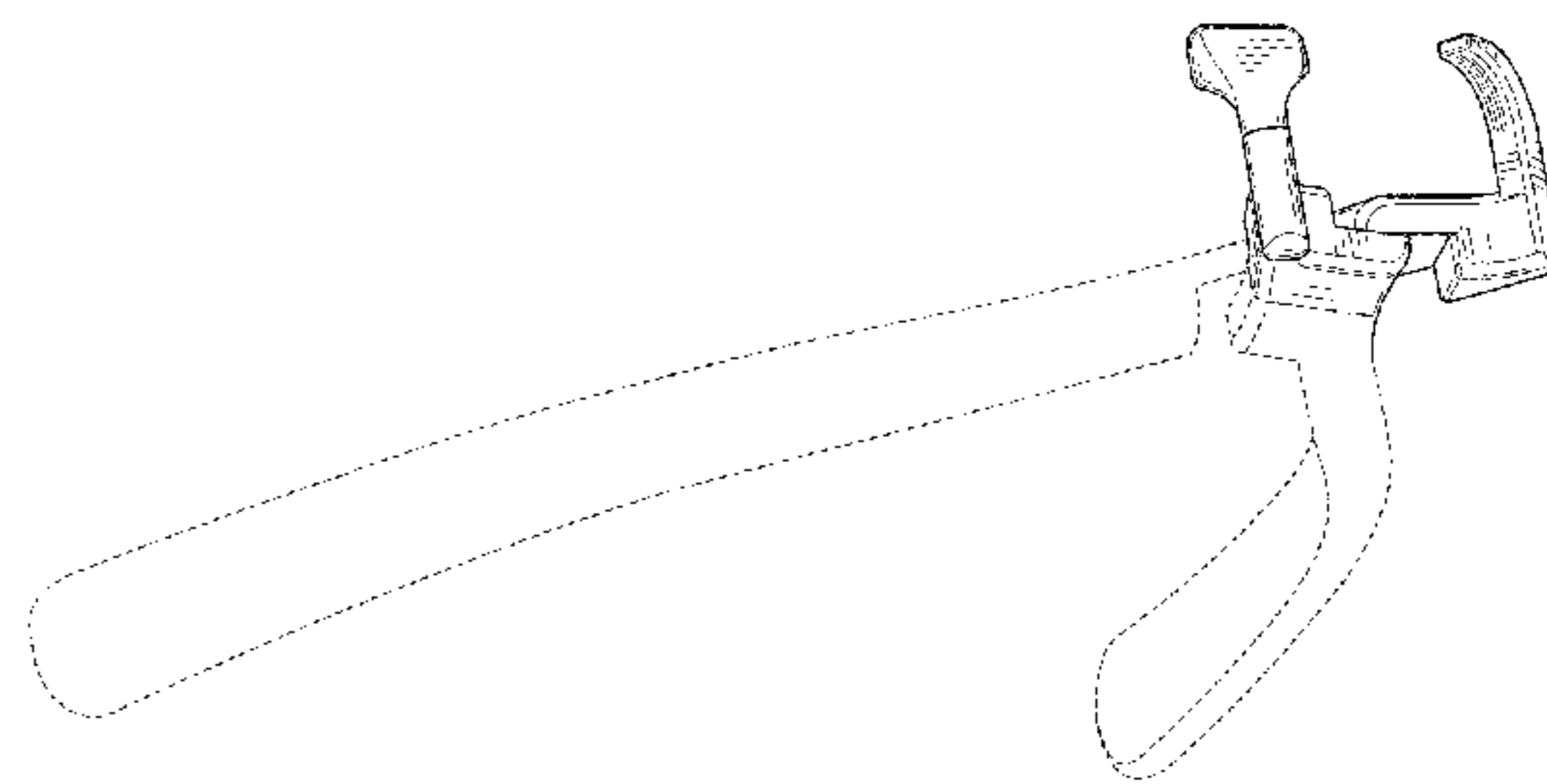
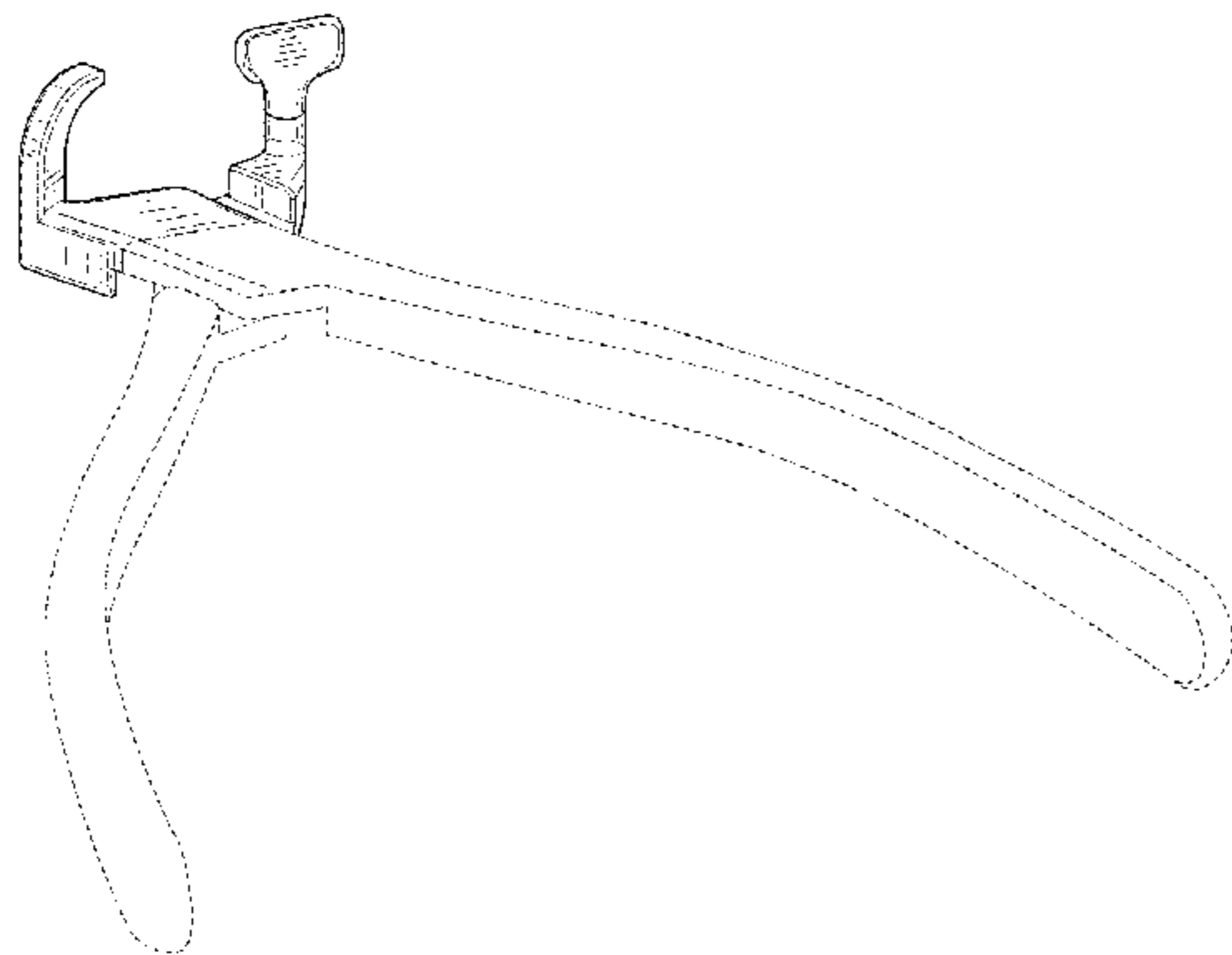

(56)

References Cited

U.S. PATENT DOCUMENTS

1,034,591	A *	8/1912	Douds	433/4	6,984,126	B1 *	1/2006	Graham	433/4
1,487,776	A *	3/1924	Goldberg	433/159	7,128,575	B1 *	10/2006	Sohn	433/159
D208,009	S *	6/1967	Hearrell	D8/58	D695,084	S *	12/2013	Jensen	D8/52
4,081,909	A *	4/1978	Garcia	433/4	2010/0240008	A1 *	9/2010	Golden	433/159
						2011/0027754	A1 *	2/2011	Golden	433/159
						2013/0244201	A1 *	9/2013	Lim	433/159

* cited by examiner

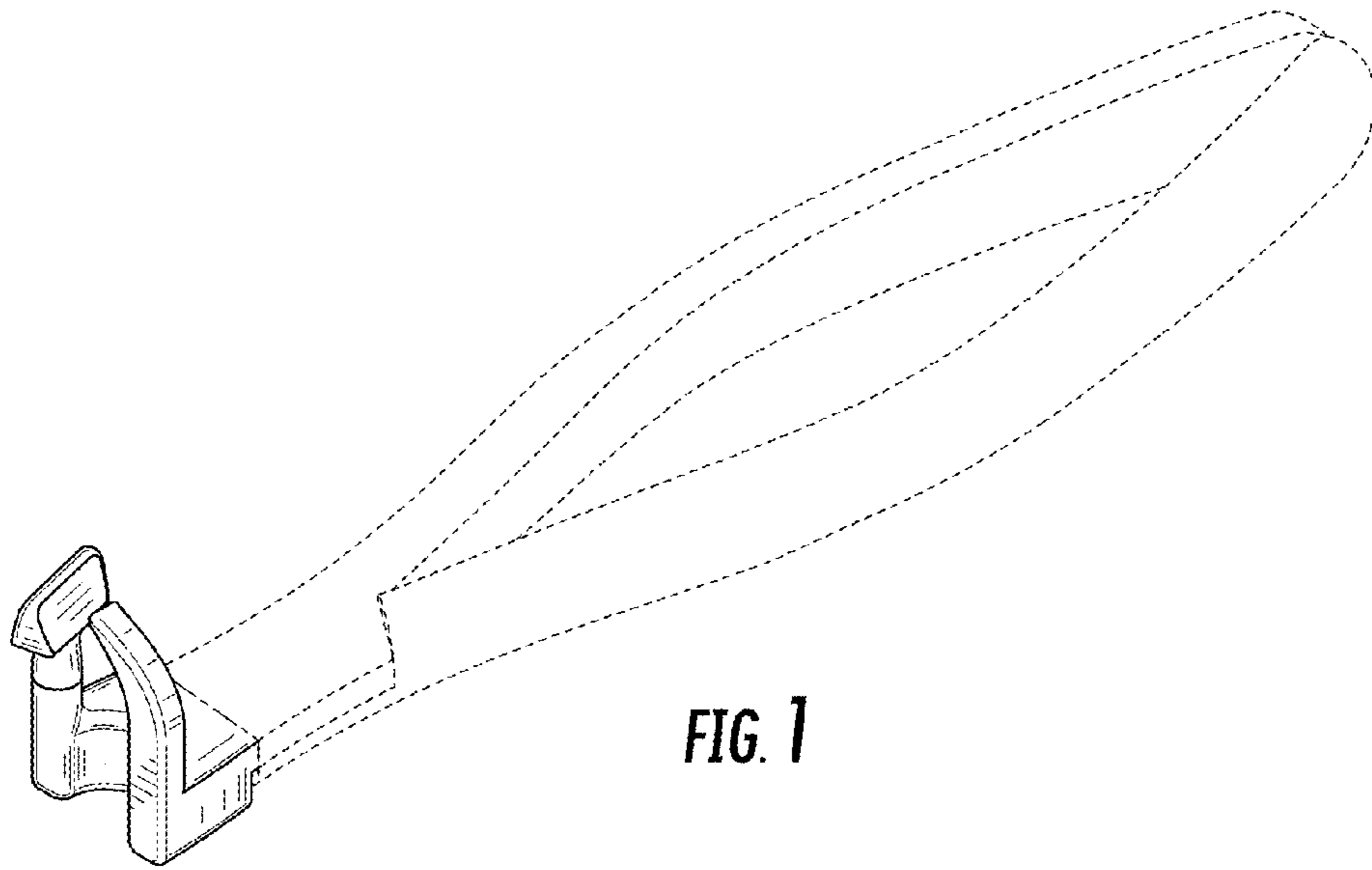

FIG. 1

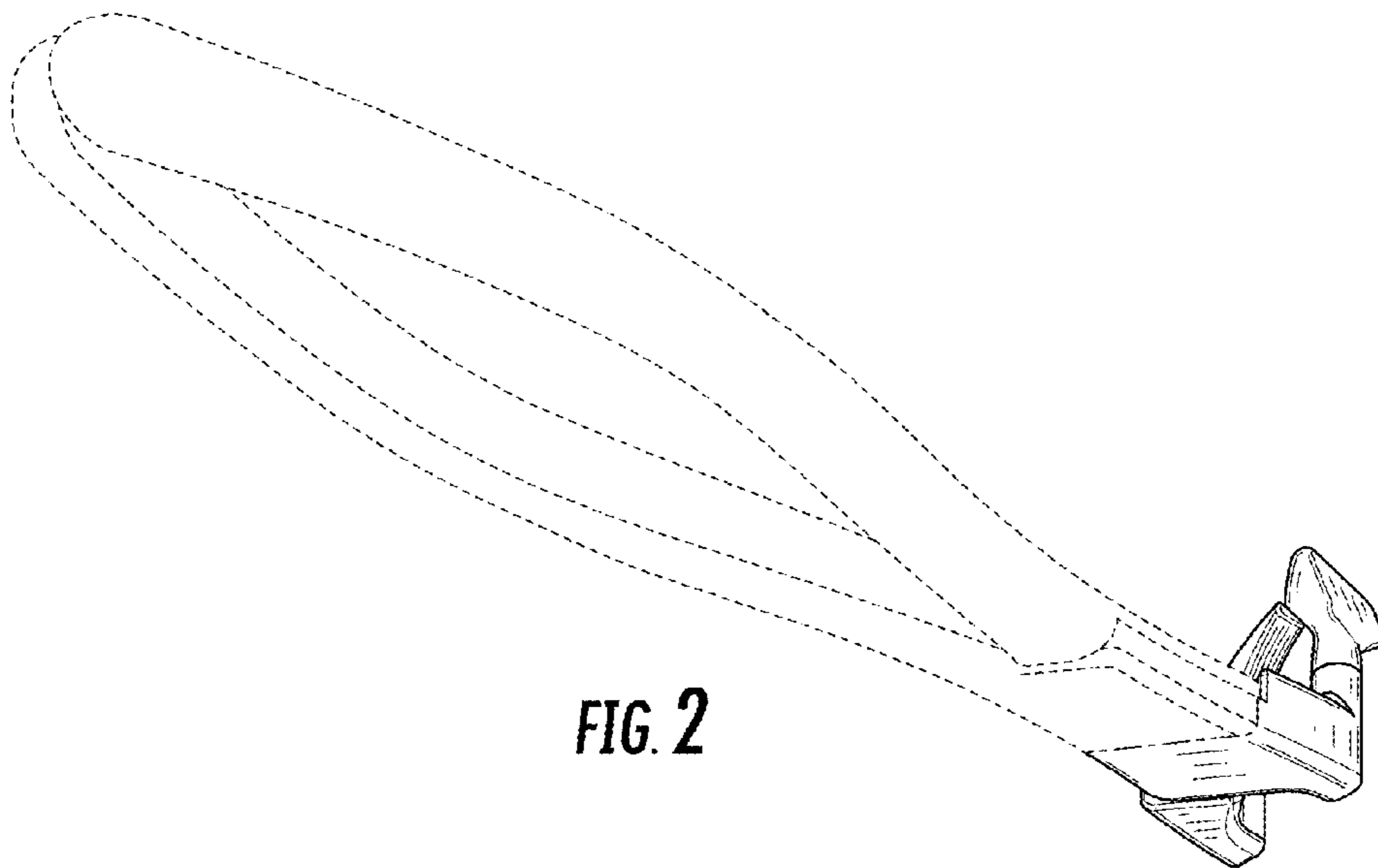

FIG. 2

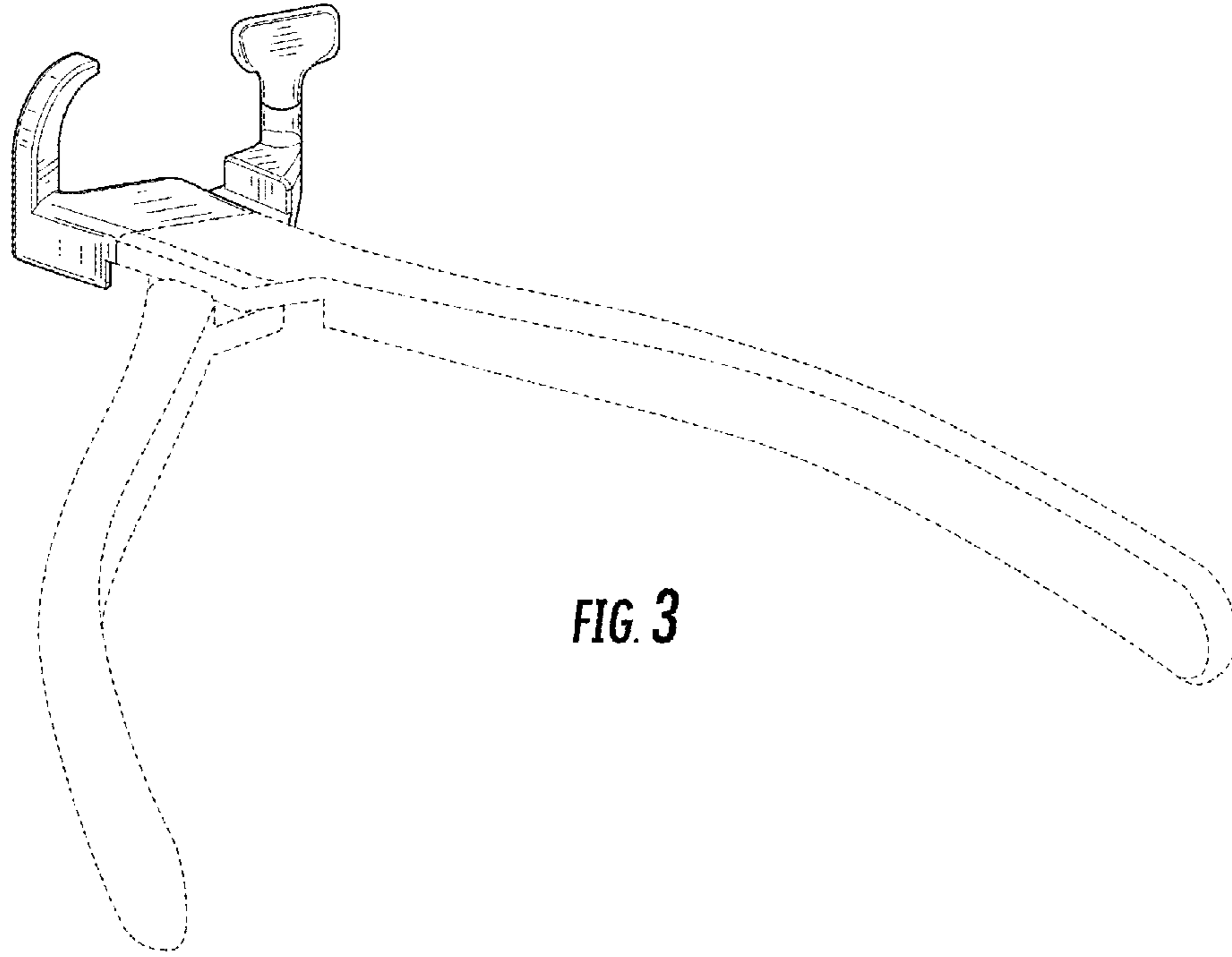

FIG. 3

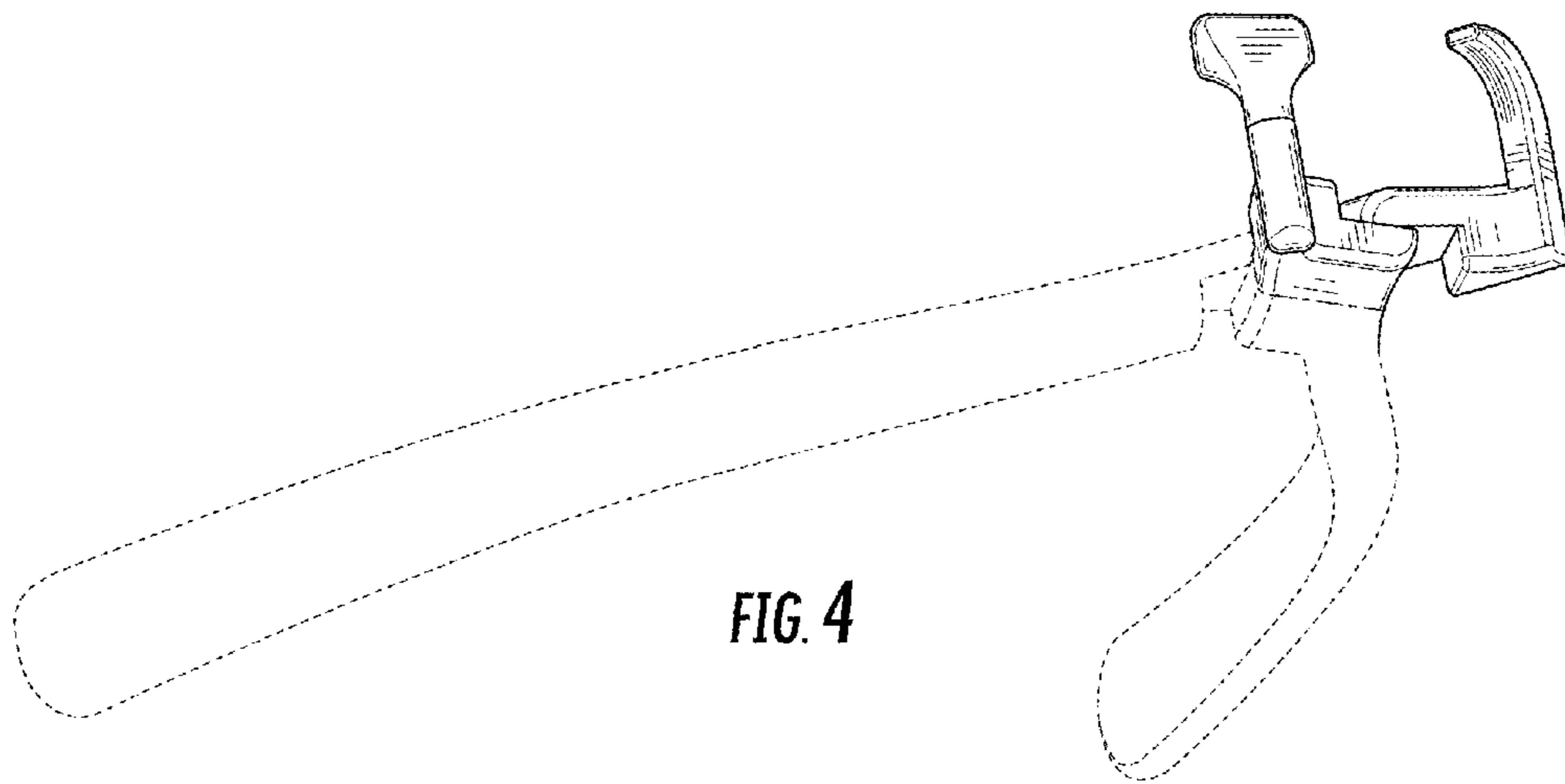

FIG. 4

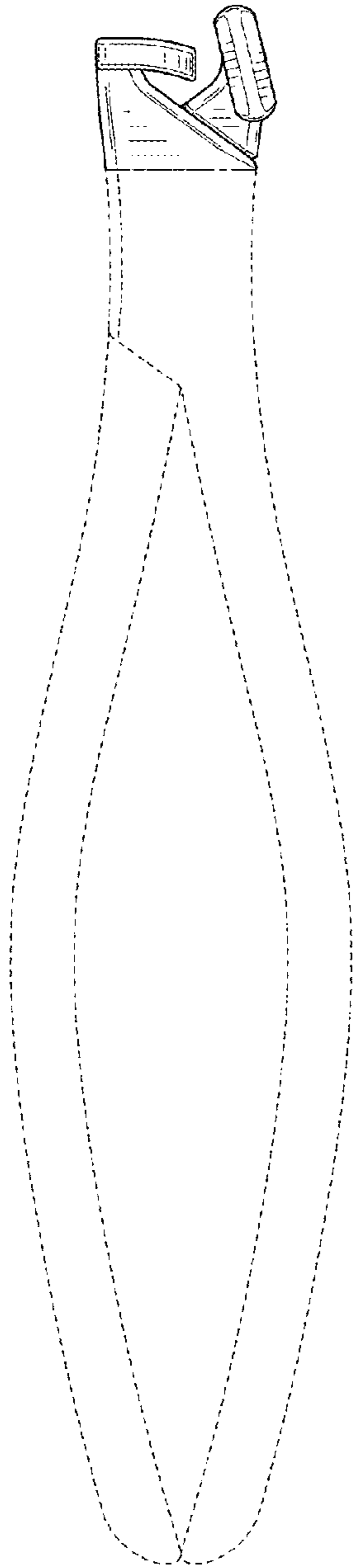

FIG. 5

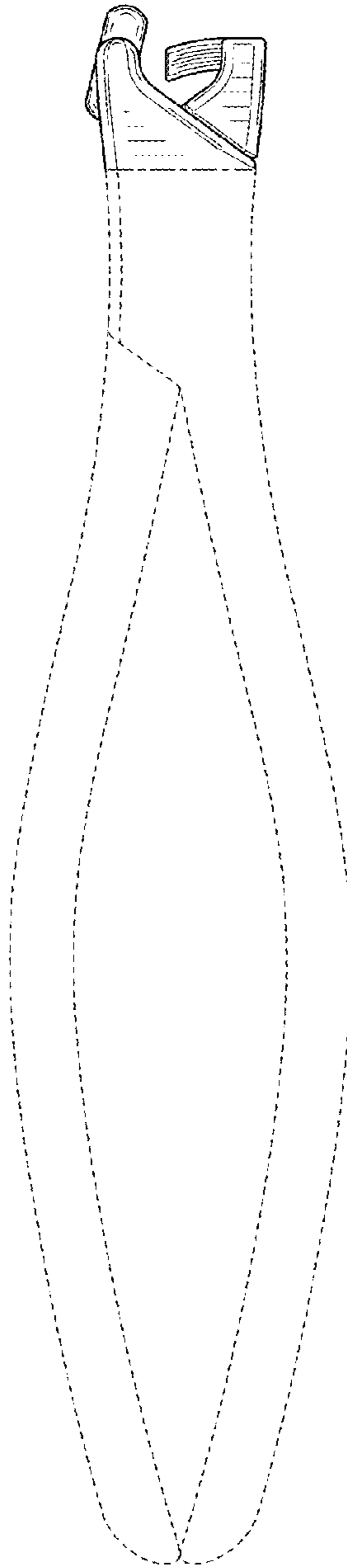

FIG. 6

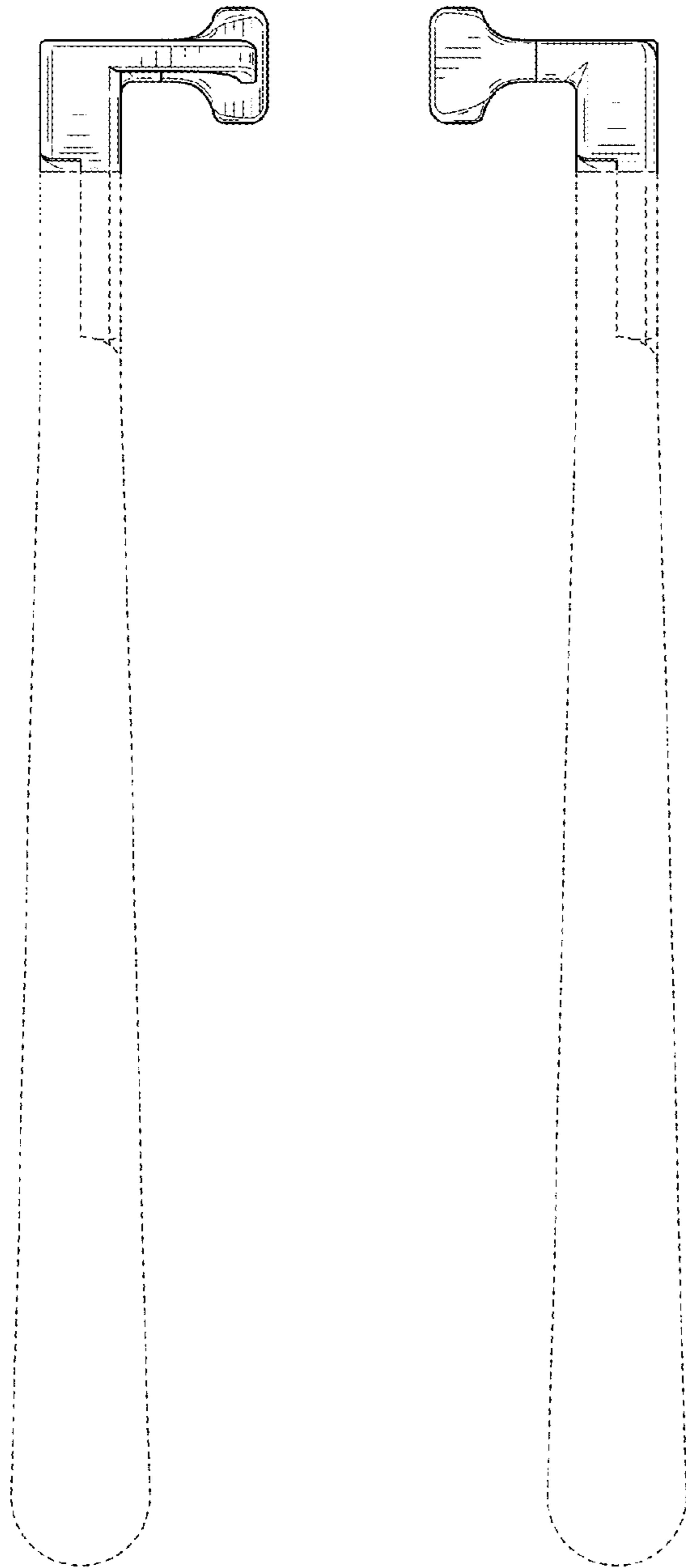

FIG. 7

FIG. 8

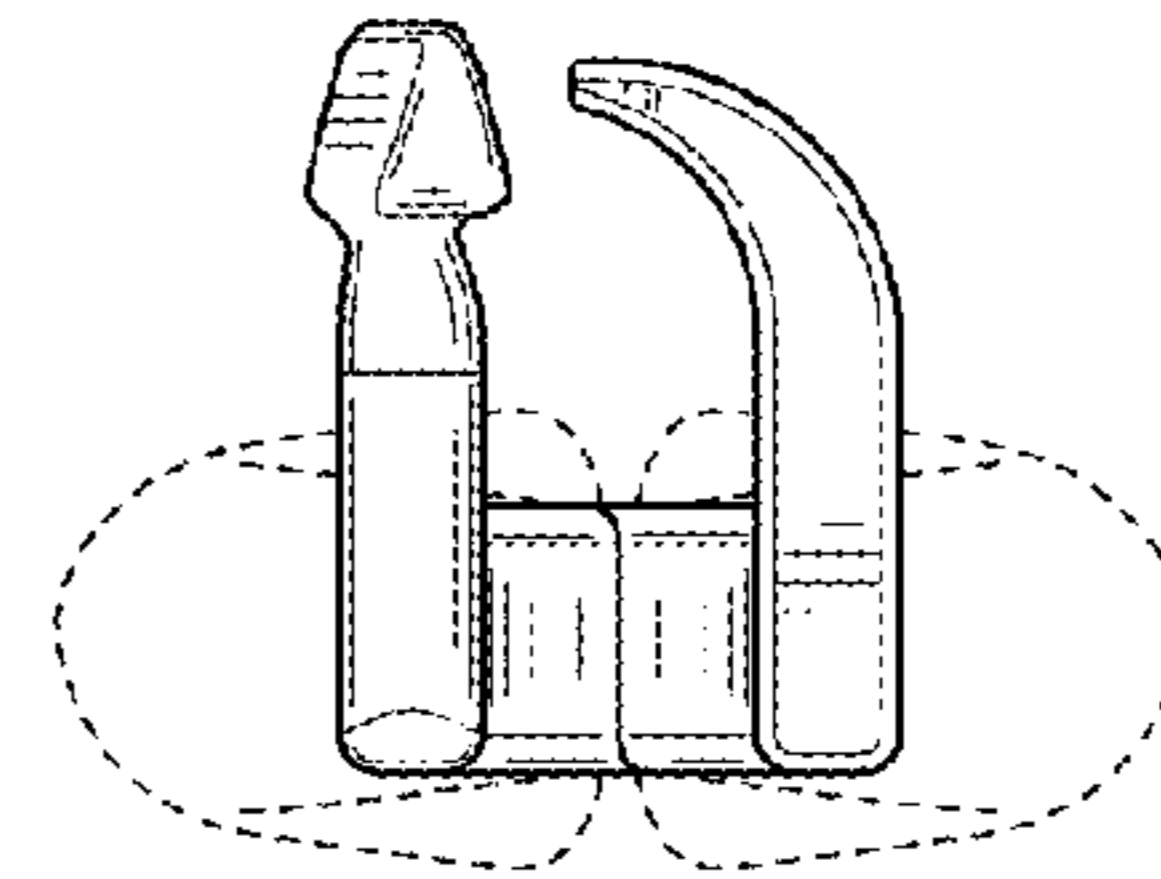

FIG. 9

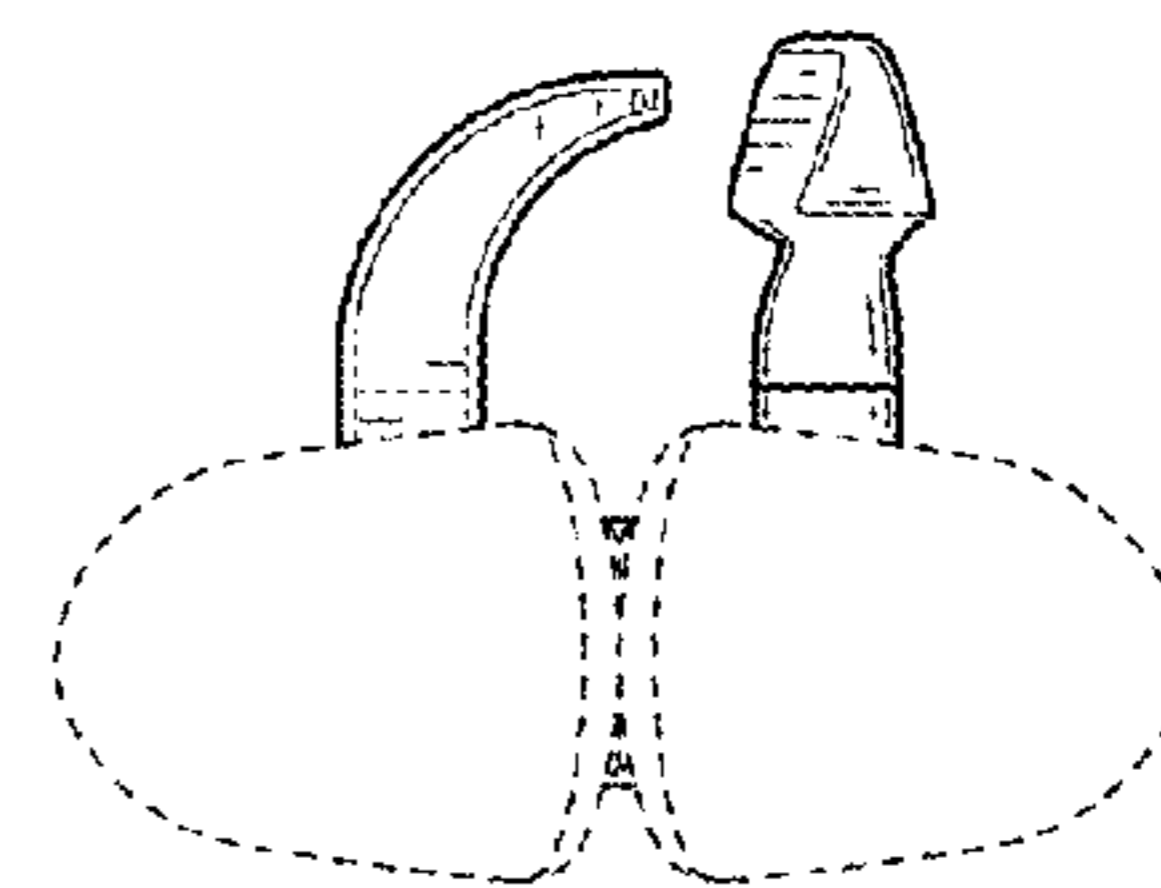

FIG. 10

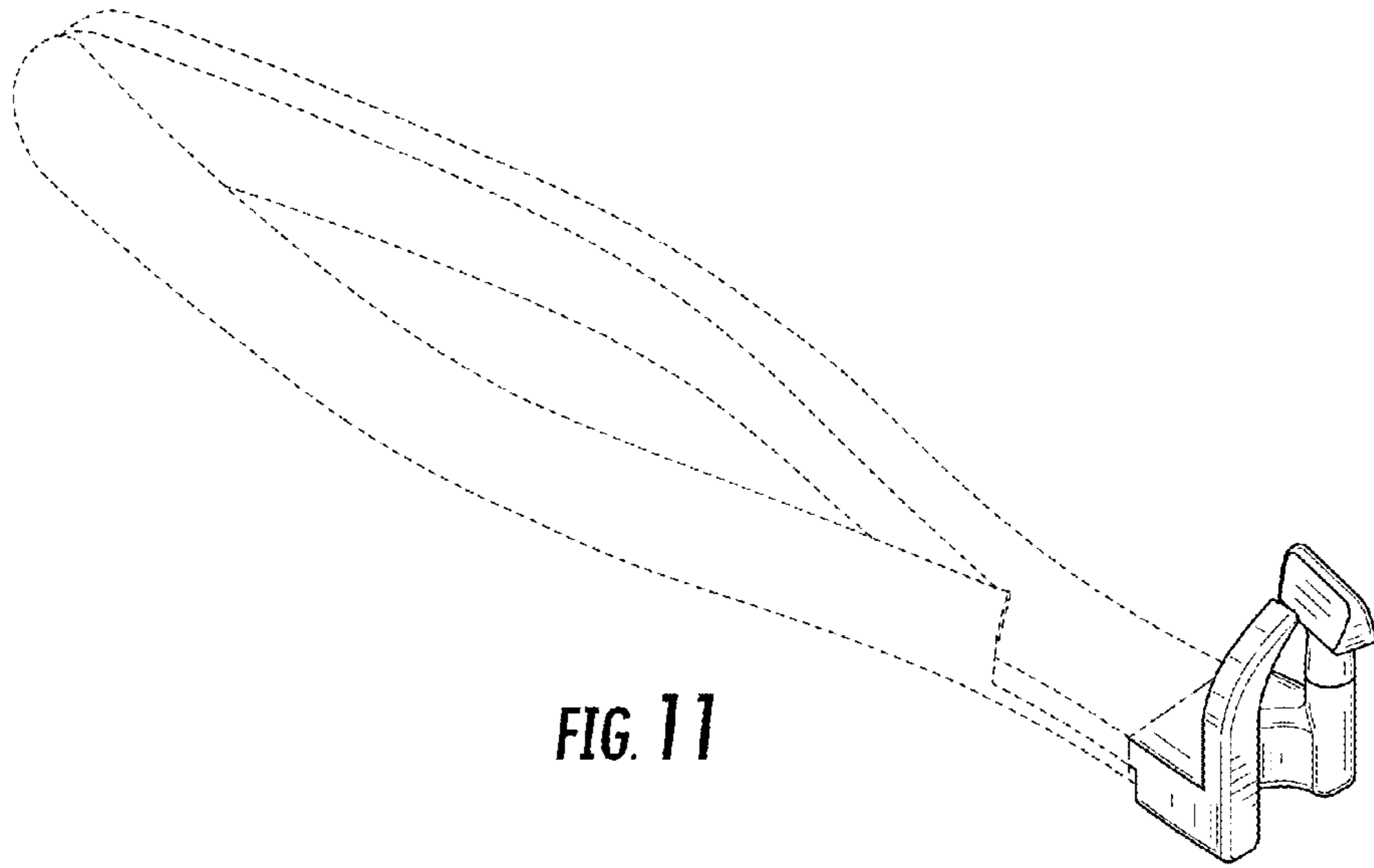

FIG. 11

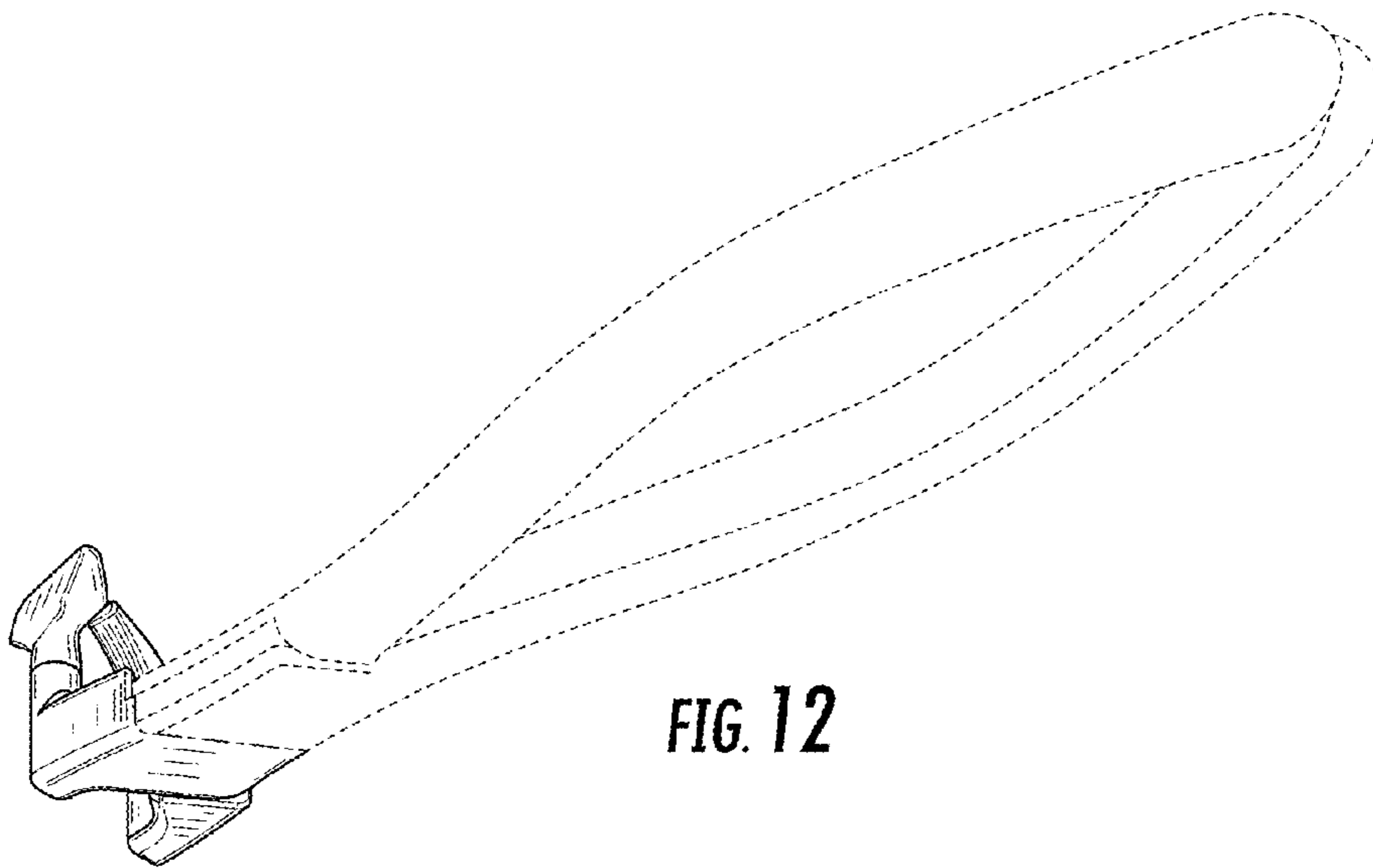

FIG. 12

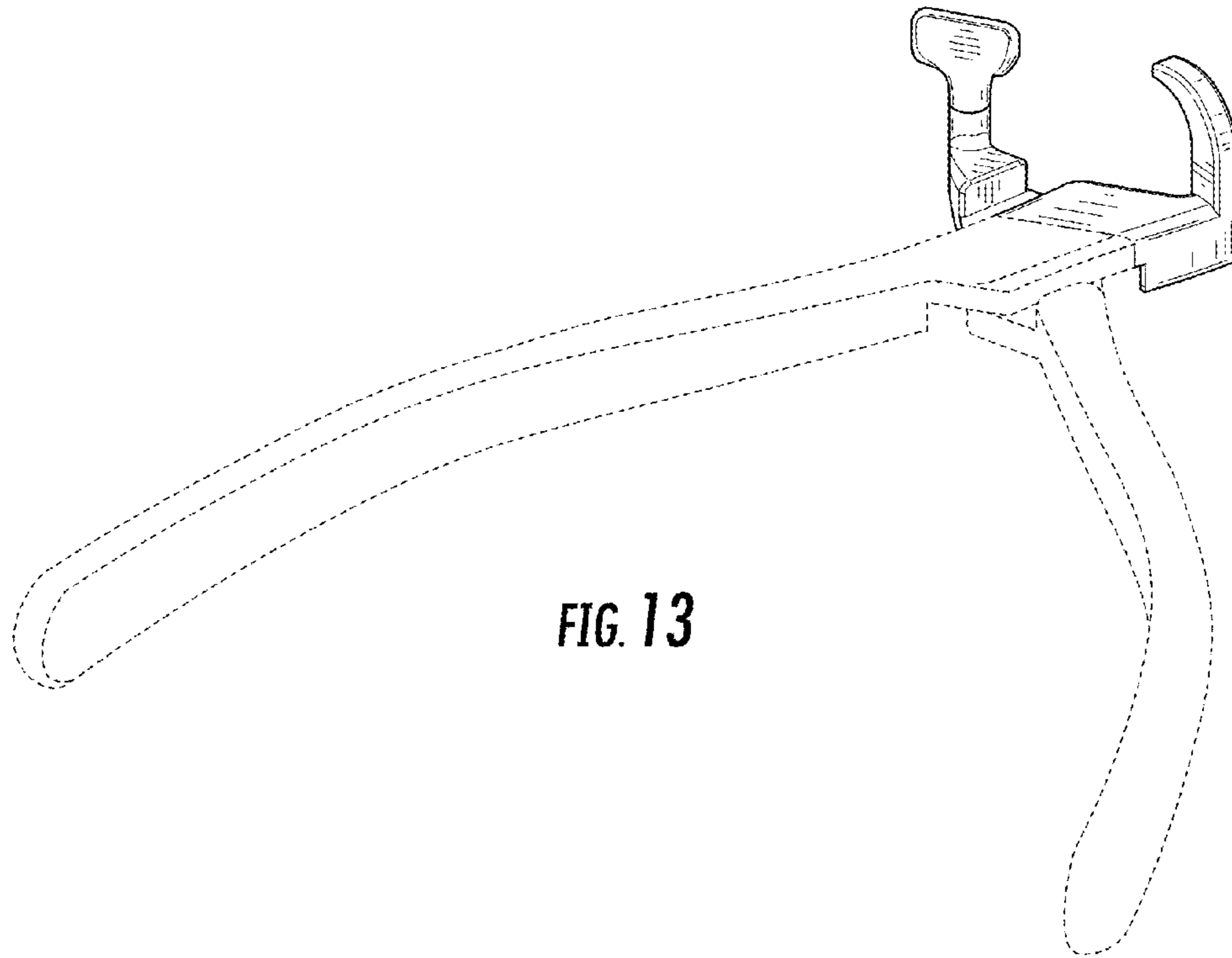

FIG. 13

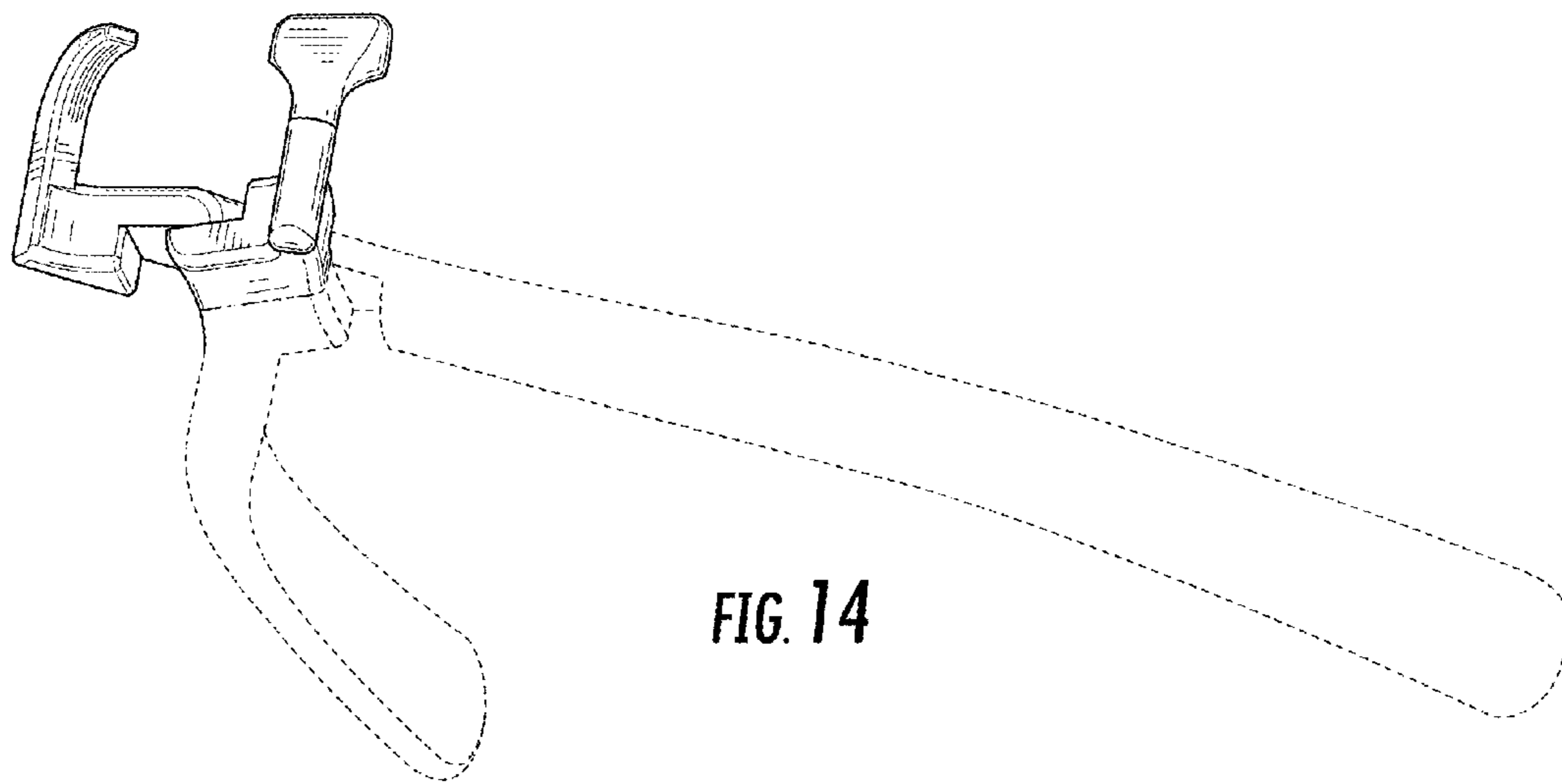

FIG. 14

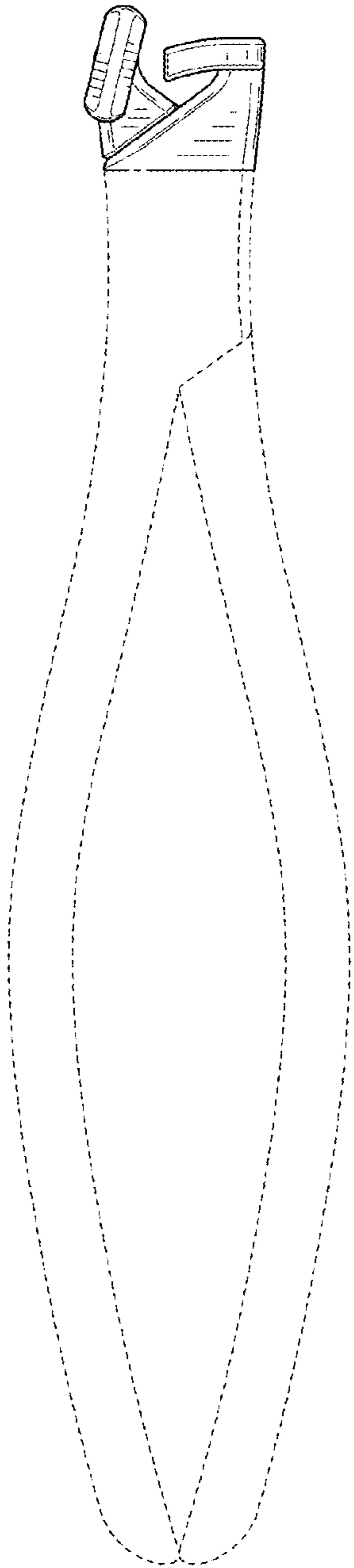

FIG. 15

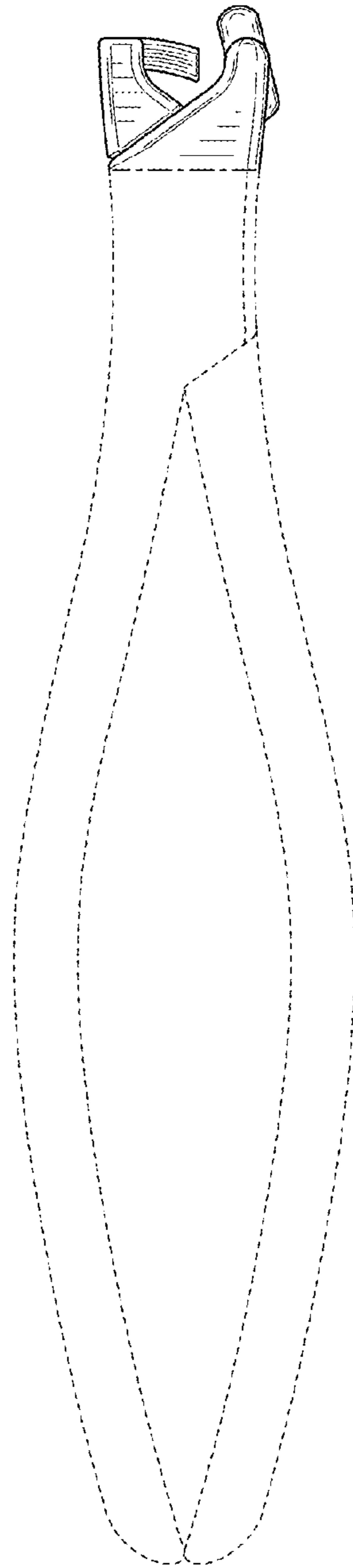

FIG. 16

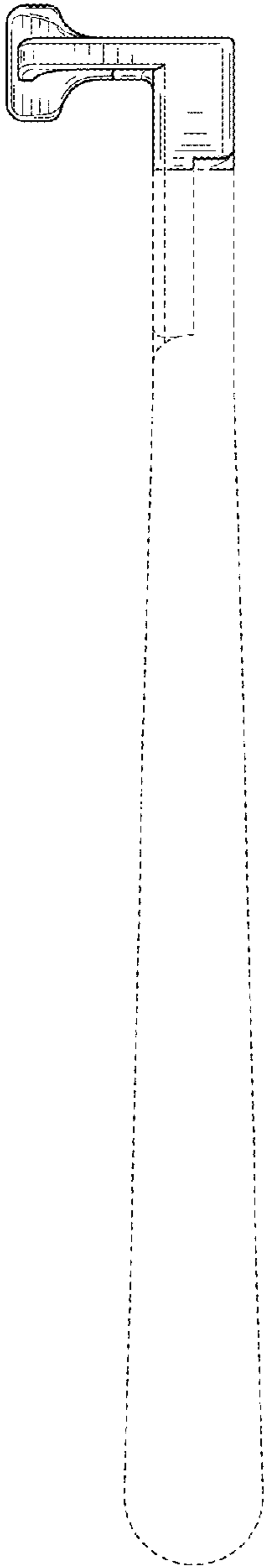

FIG. 17

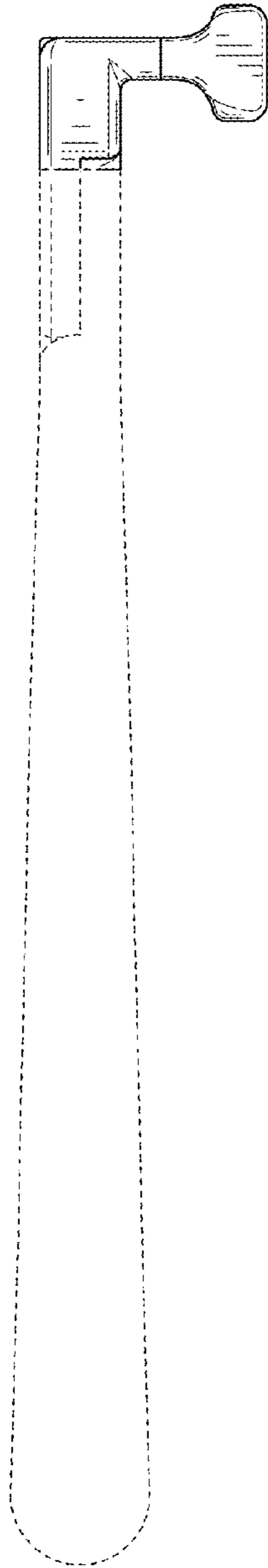

FIG. 18

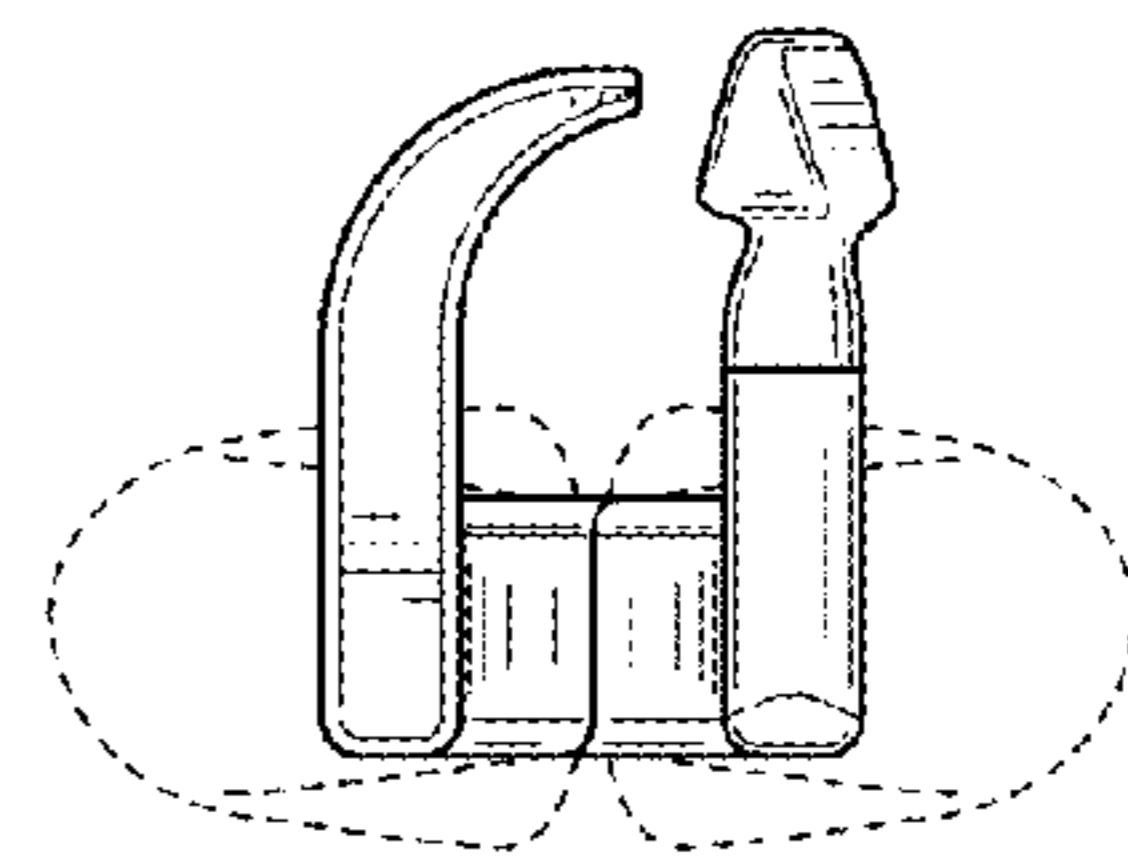

FIG. 19

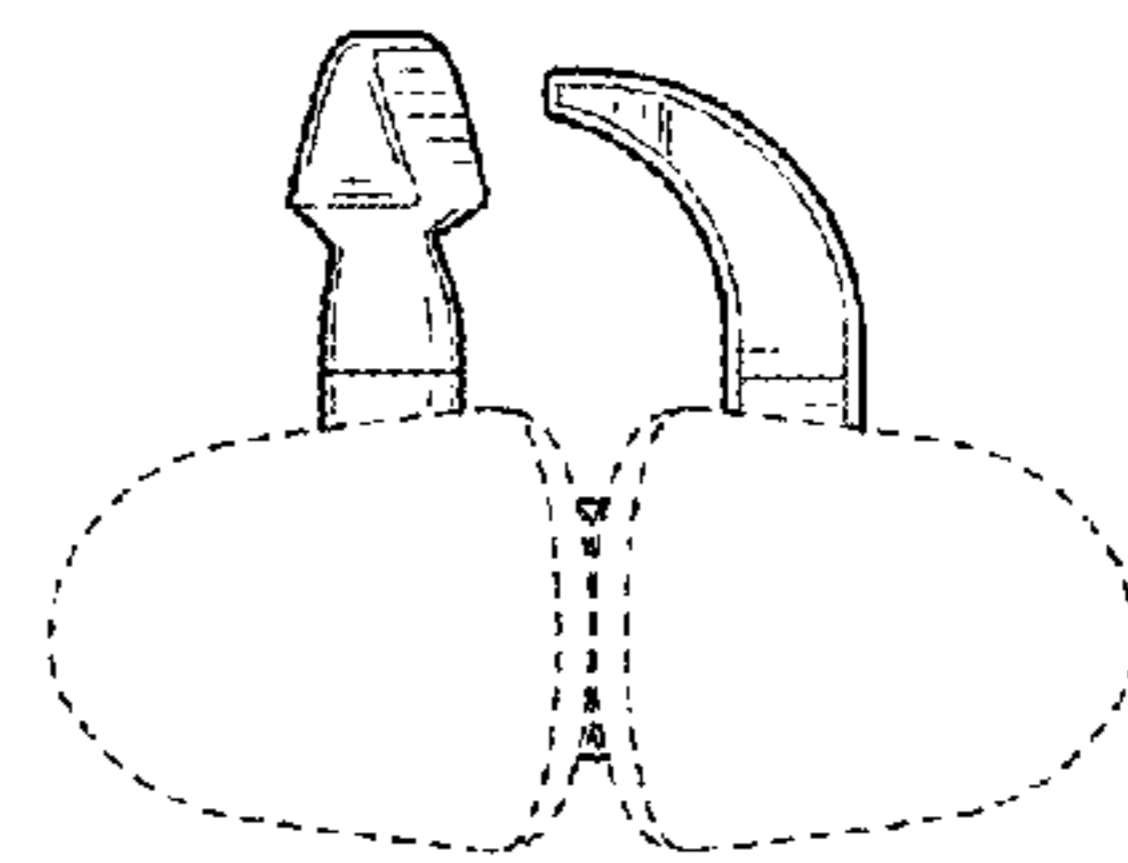

FIG. 20