



US00D719611S

(12) **United States Design Patent**
Wang

(10) **Patent No.:** **US D719,611 S**

(45) **Date of Patent:** **** Dec. 16, 2014**

(54) **BALL PEN**

(71) Applicant: **Tonglu Ido Imp & Exp Co., Ltd.**,
Hangzhou, Zhejiang (CN)

(72) Inventor: **Andrew Wang**, Anhui (CN)

(73) Assignee: **Tonglu Ido Imp & Exp Co., Ltd.**,
Fenshui Town, Tonglu, Hangzhou,
Zhejiang Province (CN)

(**) Term: **14 Years**

(21) Appl. No.: **29/462,044**

(22) Filed: **Jul. 30, 2013**

(51) **LOC (10) Cl.** **19-06**

(52) **U.S. Cl.**
USPC **D19/170**

(58) **Field of Classification Search**
USPC D14/411; D19/115-186, 190-204;
24/11 F, 11 P, 11 R; 401/52, 99, 192,
401/195, 196

See application file for complete search history.

(56) **References Cited**

U.S. PATENT DOCUMENTS

3,343,292	A *	9/1967	Jorgensen	40/334
3,597,100	A *	8/1971	Ganz	401/110
3,792,931	A *	2/1974	Ganz	401/109
D332,637	S *	1/1993	Hesse	D19/48

D366,498	S *	1/1996	Abe et al.	D19/51
D382,016	S *	8/1997	Takahashi	D19/51
D387,804	S *	12/1997	Izushima	D19/51
D389,866	S *	1/1998	Boix Gacia	D19/51
D401,280	S *	11/1998	Chevalier et al.	D19/57
6,227,743	B1 *	5/2001	Robb	401/243
D451,139	S *	11/2001	Wang	D19/36
D508,527	S *	8/2005	Hung	D19/36
D516,625	S *	3/2006	Bertheaux	D19/51
D619,651	S *	7/2010	Zhang	D19/51
D645,083	S *	9/2011	Stukenkemper	D19/48
D669,896	S *	10/2012	Nakata	D14/411
D670,289	S *	11/2012	Bae et al.	D14/411
D682,275	S *	5/2013	Nakata	D14/411
D695,829	S *	12/2013	Hern et al.	D19/170

* cited by examiner

Primary Examiner — Elizabeth Albert

(74) *Attorney, Agent, or Firm* — Tianhua Gu; Global IP Services

(57) **CLAIM**

The ornamental design for a ball pen, as shown and described.

DESCRIPTION

FIG. 1 is a front elevation view of a ball pen showing my new design;

FIG. 2 is a rear elevation view thereof;

FIG. 3 is a left elevation view thereof;

FIG. 4 is a right elevation view thereof;

FIG. 5 is a bottom plan view thereof; and,

FIG. 6 is a top plan view thereof.

1 Claim, 3 Drawing Sheets

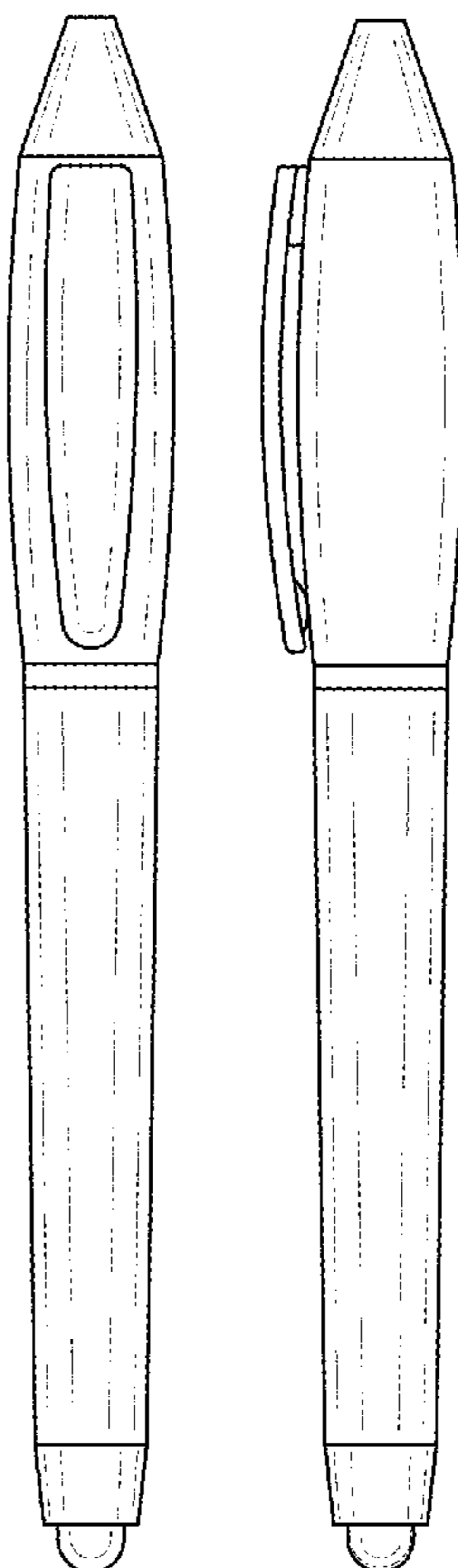

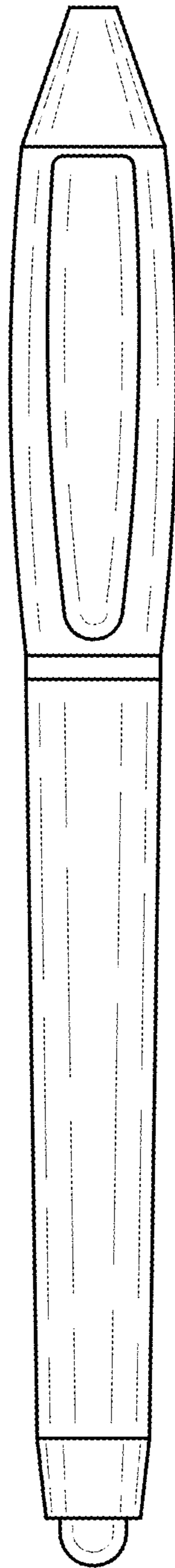

FIG. 1

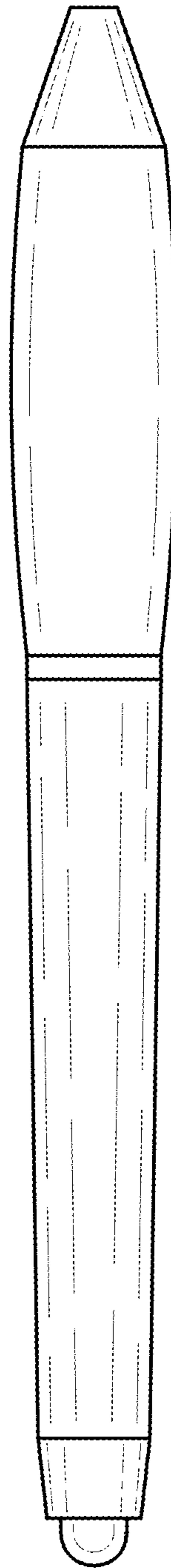

FIG. 2

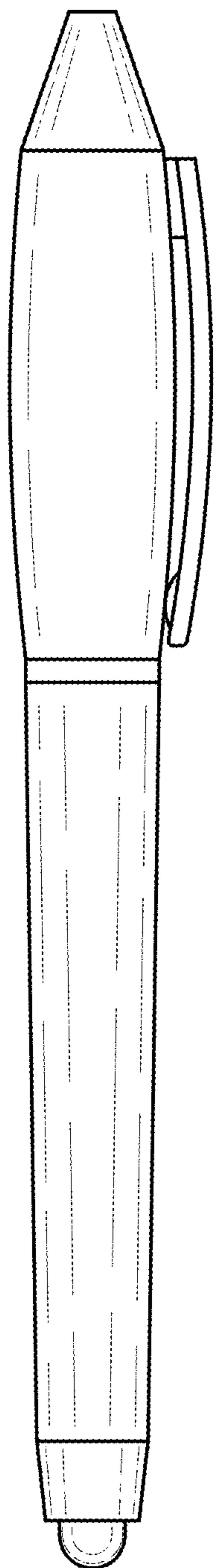

FIG. 3

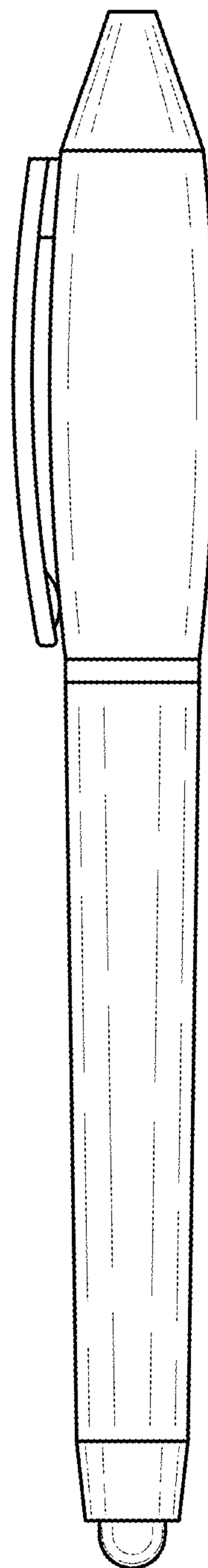

FIG. 4

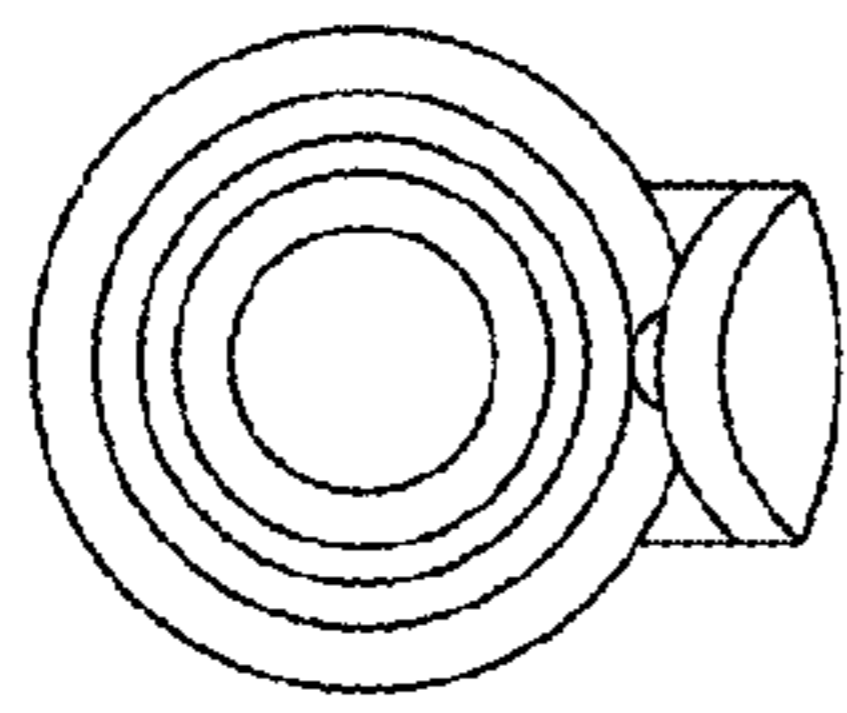

FIG. 5

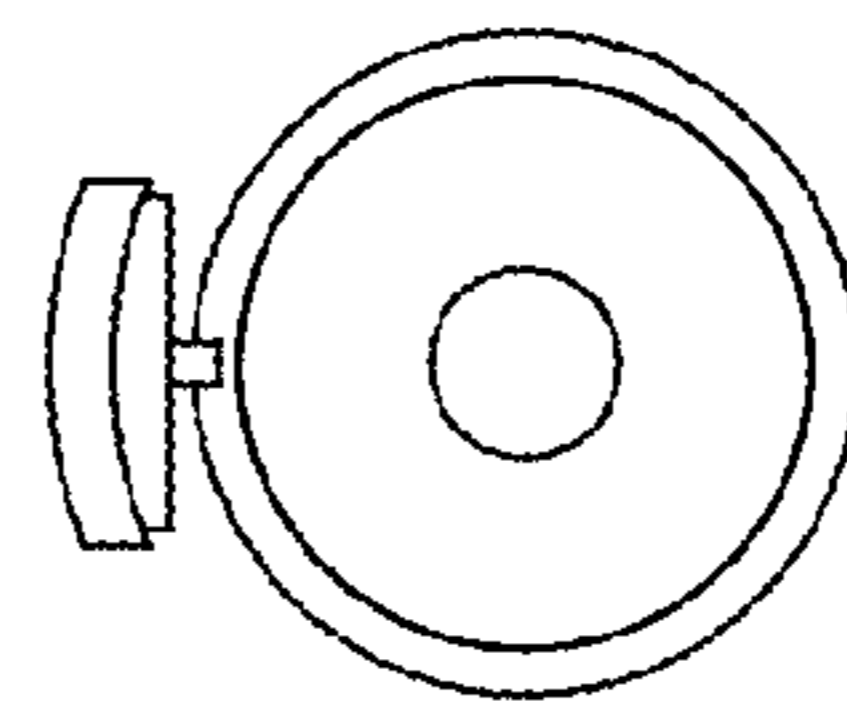

FIG. 6