



US00D719558S

(12) **United States Design Patent**  
**Cho**

(10) **Patent No.:** **US D719,558 S**

(45) **Date of Patent:** **\*\* Dec. 16, 2014**

(54) **HANDSET**

(71) Applicant: **Nokia Corporation**, Espoo (FI)

(72) Inventor: **Sungwoo Cho**, Gyeongsangnam-do (KR)

(73) Assignee: **Nokia Corporation**, Espoo (FI)

(\*\*) Term: **14 Years**

(21) Appl. No.: **29/500,971**

(22) Filed: **Aug. 29, 2014**

**Related U.S. Application Data**

(62) Division of application No. 29/452,863, filed on Apr. 22, 2013.

(51) **LOC (10) Cl.** ..... **14-03**

(52) **U.S. Cl.**  
USPC ..... **D14/248**

(58) **Field of Classification Search**  
CPC ..... H04M 1/02; H04M 1/0202-1/035;  
H04M 1/0235; H04M 1/0237; H04M 1/0239;  
H04M 2250/22; H04M 1/23; H04M 1/0236;  
H04M 1/26; H04M 1/03; H04M 1/72519;  
G06F 1/1626  
USPC ..... D14/138 AA, 138 AB, 138 G, 138 AD,  
D14/138 R, 496, 203.1, 203.3, 203.4, 203.5,  
D14/203.7, 248, 218, 341, 345, 346,  
D14/138 AC, 147, 247, 439; 455/575.1,  
455/556.2, 575.3, 575.4; D21/517;  
379/433.01, 433.04, 433.12, 433.13;  
D13/168; 361/679.3, 679.56; D10/65,  
D10/78, 104.1

See application file for complete search history.

(56) **References Cited**

U.S. PATENT DOCUMENTS

D546,810 S	7/2007	Kwak	
D548,218 S	8/2007	Hong et al.	
D572,697 S	7/2008	Lee et al.	
D572,715 S	7/2008	Gloscia et al.	
D582,372 S	12/2008	Lee et al.	
D583,369 S *	12/2008	Boyd et al.	D14/248
D584,262 S *	1/2009	Hu et al.	D14/138 AA
D587,696 S *	3/2009	Aarras	D14/248

(Continued)

FOREIGN PATENT DOCUMENTS

IN	226595	12/2009
KR	30-0515655	12/2008
RU	70902	6/2009
RU	79062	7/2011

OTHER PUBLICATIONS

Office Action received in corresponding Russian Application No. 2013504103 issued on Jun. 12, 2014. 6 pages.

(Continued)

*Primary Examiner* — Jeffrey D Asch  
(74) *Attorney, Agent, or Firm* — Banner & Witcoff, Ltd.

(57) **CLAIM**  
The ornamental design for a handset, as shown and described.

**DESCRIPTION**

FIG. 1 is a perspective front view of a handset showing my new design;  
FIG. 2 is a front plan view thereof;  
FIG. 3 is a rear plan view thereof;  
FIG. 4 is a right side view thereof;  
FIG. 5 is a left side view thereof;  
FIG. 6 is a top plan view thereof; and,  
FIG. 7 is a bottom plan view thereof.  
The broken lines and the unshaded regions within the broken lines show portions of the handset and form no part of the claimed design.

**1 Claim, 5 Drawing Sheets**

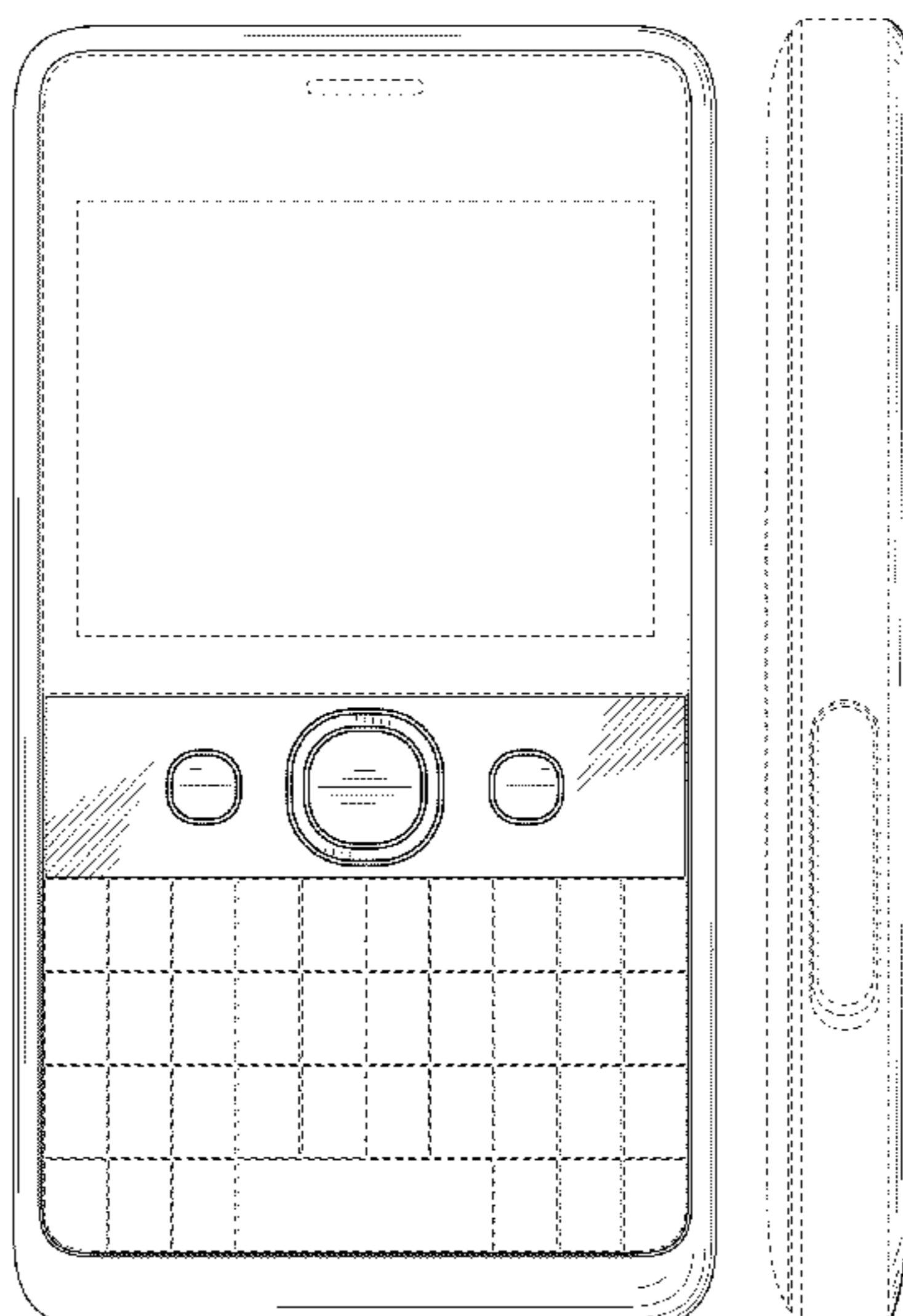

(56)

References Cited

U.S. PATENT DOCUMENTS

D590,821 S 4/2009 Rouger  
 D591,278 S 4/2009 Rouger  
 D598,887 S 8/2009 Xiao et al.  
 D600,229 S 9/2009 Kangasmaa  
 D600,231 S 9/2009 Lee et al.  
 D601,528 S 10/2009 Lim et al.  
 D601,529 S 10/2009 Rouger  
 D601,541 S 10/2009 Lee et al.  
 D611,922 S 3/2010 Yoshihara  
 D612,349 S 3/2010 Lee  
 D613,730 S \* 4/2010 Rouger et al. .... D14/248  
 D615,524 S 5/2010 He  
 D618,656 S 6/2010 Hunt  
 D627,343 S \* 11/2010 Andre et al. .... D14/341  
 D627,751 S 11/2010 Kim et al.  
 D628,187 S 11/2010 Huang  
 D631,450 S 1/2011 Moss  
 D633,458 S 3/2011 Jinkinson et al.  
 D633,903 S 3/2011 Rouger et al.  
 D636,370 S 4/2011 Huang  
 D637,988 S \* 5/2011 Jinkinson ..... D14/138 AA  
 D639,285 S \* 6/2011 Harrison ..... D14/248  
 D643,395 S 8/2011 Moss  
 D649,134 S 11/2011 Lee  
 D661,278 S 6/2012 Wang  
 D661,288 S 6/2012 Wang  
 D661,678 S 6/2012 Kim  
 D673,562 S 1/2013 Johnson  
 D675,183 S 1/2013 Suk  
 D675,185 S 1/2013 Han  
 D675,591 S 2/2013 Han  
 D678,854 S 3/2013 Chung  
 D680,987 S \* 4/2013 Suk ..... D14/138 AA  
 D681,586 S \* 5/2013 Suk ..... D14/138 AA  
 D682,241 S \* 5/2013 Choi ..... D14/138 AA  
 D682,243 S 5/2013 Yoo  
 D688,652 S 8/2013 Yang

8,583,195 B2 11/2013 Dearden  
 8,666,305 B2 3/2014 Al Qalqili et al.  
 8,717,201 B2 \* 5/2014 Tai et al. .... 341/23  
 D709,848 S \* 7/2014 Wang et al. .... D14/138 AA  
 D709,849 S \* 7/2014 Cho ..... D14/138 AA  
 D710,323 S \* 8/2014 Harmon et al. .... D14/138 AA  
 2008/0018606 A1 1/2008 Chen

OTHER PUBLICATIONS

Office Action receiving in corresponding Indian Application No. 257553 dated May 30, 2014. 2 pages.  
 Nokia Asha 210 telephone, announced Apr. 2013, [online], [site visited Apr. 29, 2014]. Available from Internet, <URL: [http://www.gsmarena.com/nokia\\_asha\\_210-5417.php](http://www.gsmarena.com/nokia_asha_210-5417.php)>.  
 Huawei G6153 telephone, announced Mar. 2013, [online], [site visited Apr. 29, 2014]. Available from Internet, <URL: [http://www.gsmarena.com/huawei\\_g6153-5739.php](http://www.gsmarena.com/huawei_g6153-5739.php)>.  
 Vodafone 546 telephone, announced Apr. 2010, [online], [site visited Apr. 29, 2014]. Available from Internet, <URL: [http://www.gsmarena.com/vodafone\\_546-3296.php](http://www.gsmarena.com/vodafone_546-3296.php)>.  
 ZTE E N72 telephone, announced Aug. 2010, [online], [site visited Apr. 29, 2014]. Available from Internet, <URL: [http://www.gsmarena.com/zte\\_e\\_n72-3485.php](http://www.gsmarena.com/zte_e_n72-3485.php)>.  
 Micromax Q7 telephone, announced May 2010, [online], [site visited Apr. 29, 2014]. Available from Internet, <URL: [http://www.gsmarena.com/micromax\\_q7-3320.php](http://www.gsmarena.com/micromax_q7-3320.php)>.  
 Gigabyte GSmart q60 telephone, announced Feb. 2007, [online], [site visited Apr. 29, 2014]. Available from Internet, <URL: [http://www.gsmarena.com/gigabyte\\_gsmart\\_q60-1918.php](http://www.gsmarena.com/gigabyte_gsmart_q60-1918.php)>.  
 LG CB630 Invision telephone, announced Aug. 2008, [online], [site visited Apr. 29, 2014]. Available from Internet, <URL: [http://www.gsmarena.com/lg\\_cb630\\_invision-2504.php](http://www.gsmarena.com/lg_cb630_invision-2504.php)>.  
 Motorola Motokey XT EX118 telephone, announced Jul. 2011, [online], [site visited Apr. 29, 2014]. Available from Internet, <URL: [http://www.gsmarena.com/motorola\\_motokey\\_xt\\_ex118-4061.php](http://www.gsmarena.com/motorola_motokey_xt_ex118-4061.php)>.

\* cited by examiner

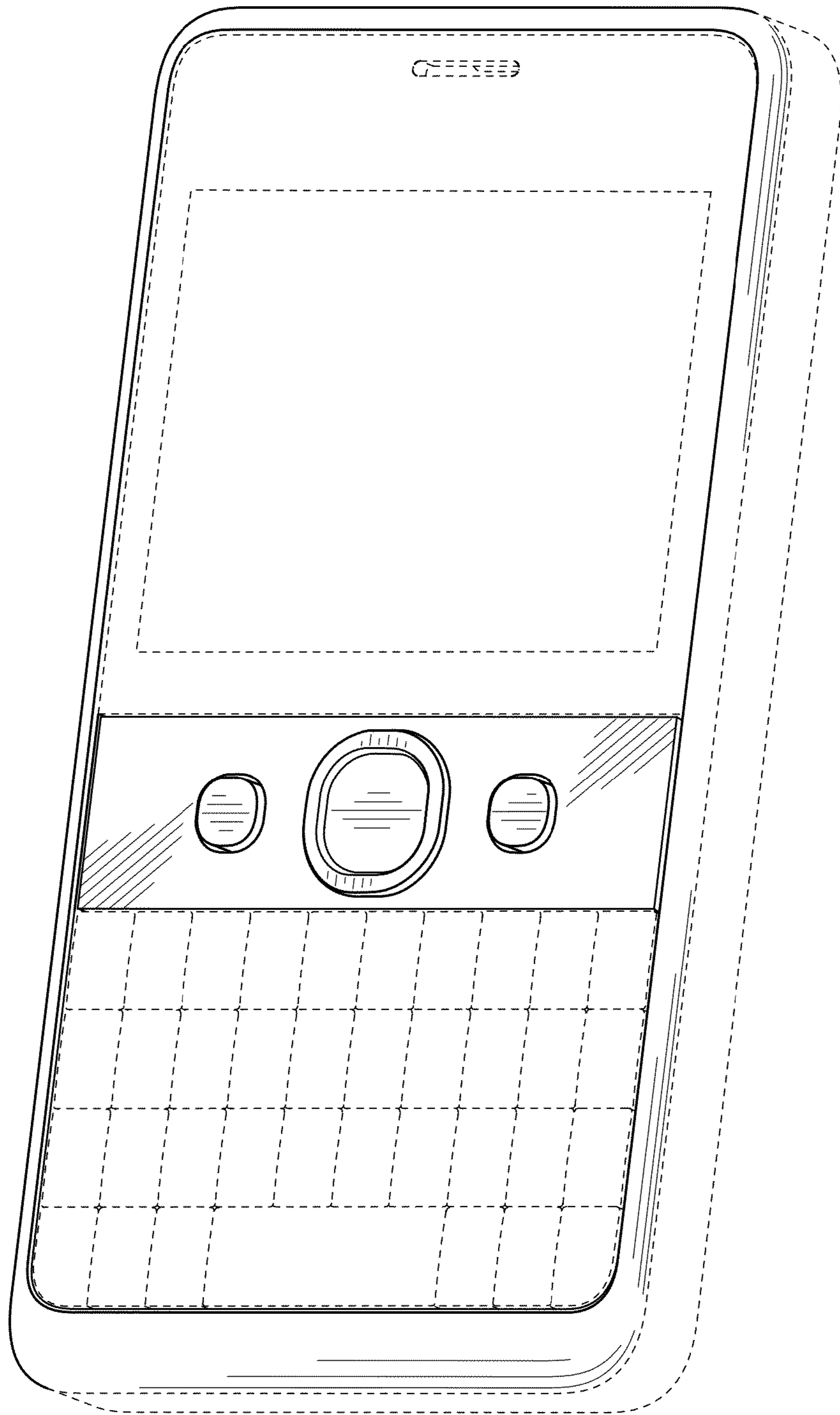

FIG. 1

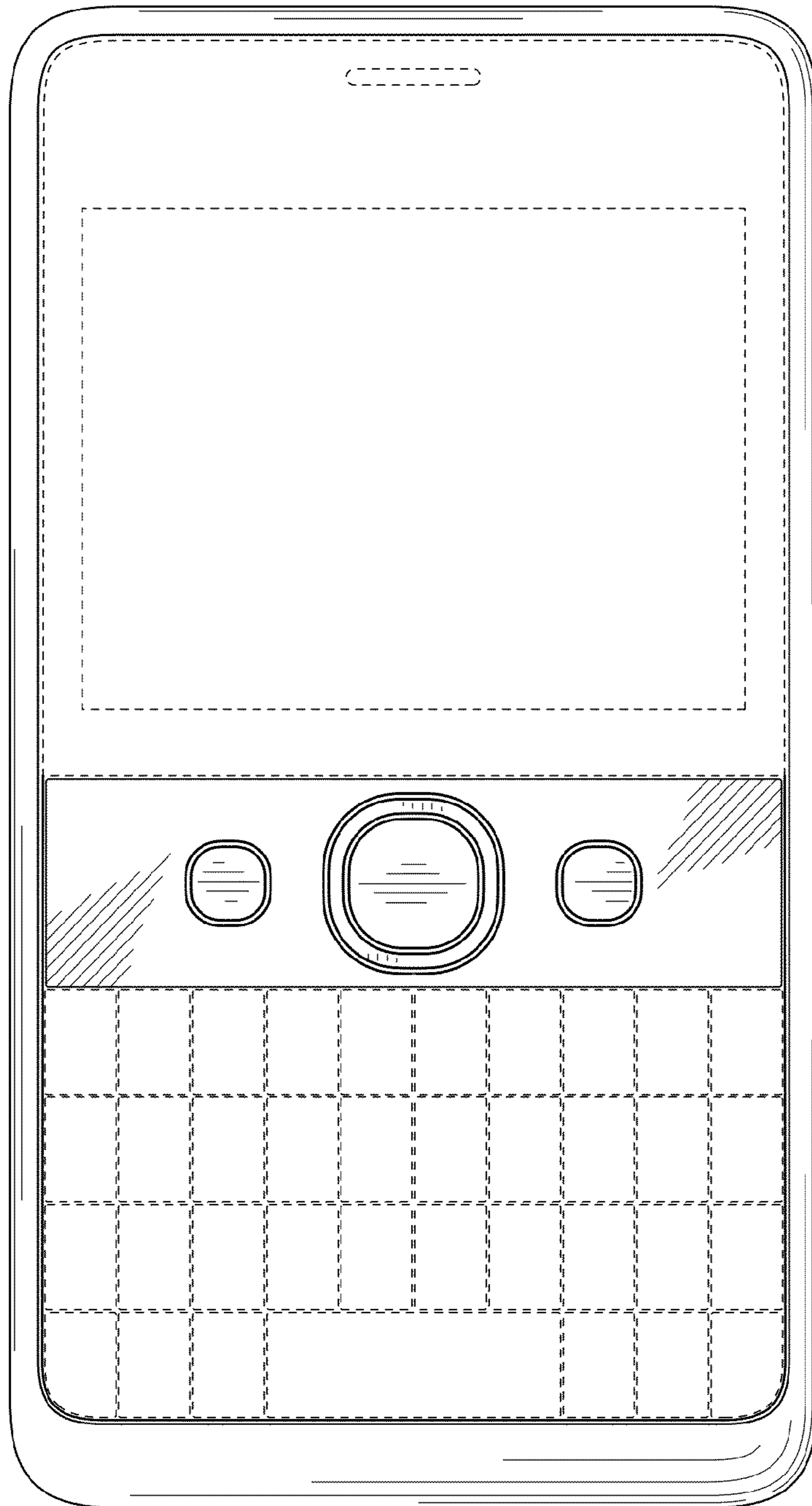
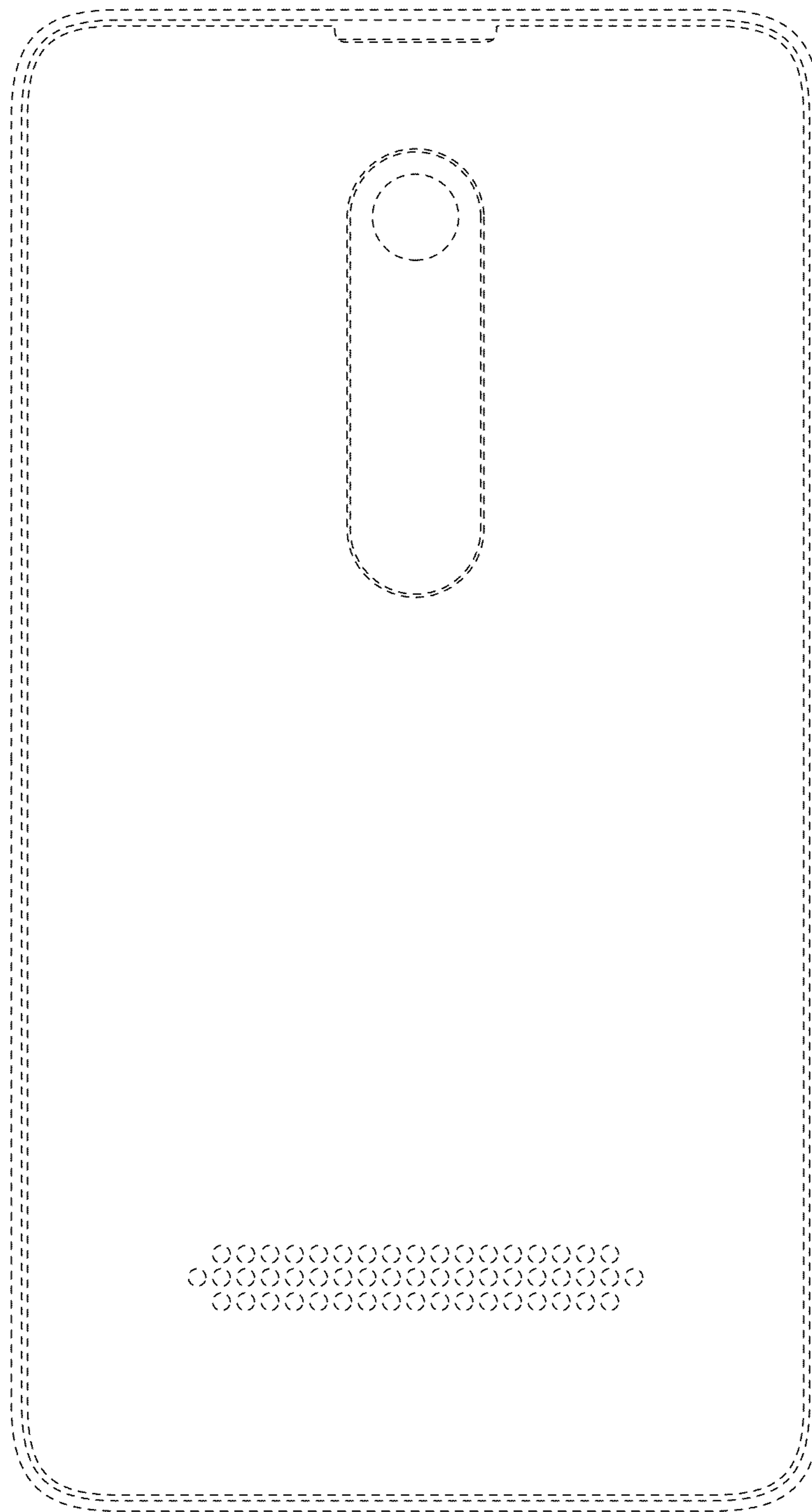

FIG. 2



**FIG. 3**

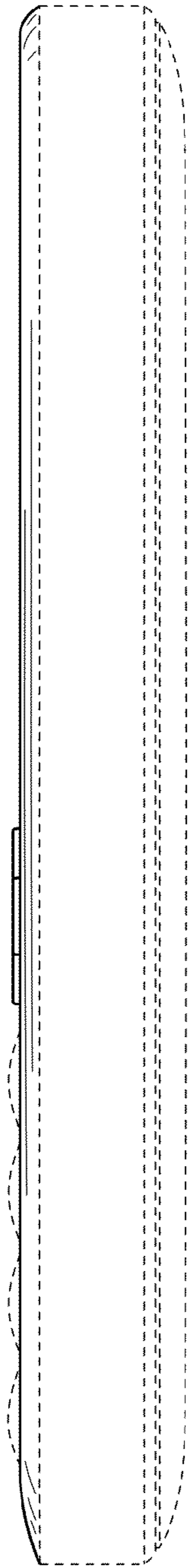

FIG. 4

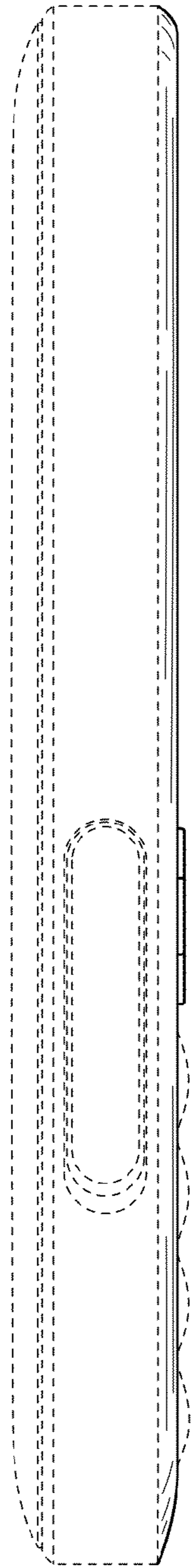
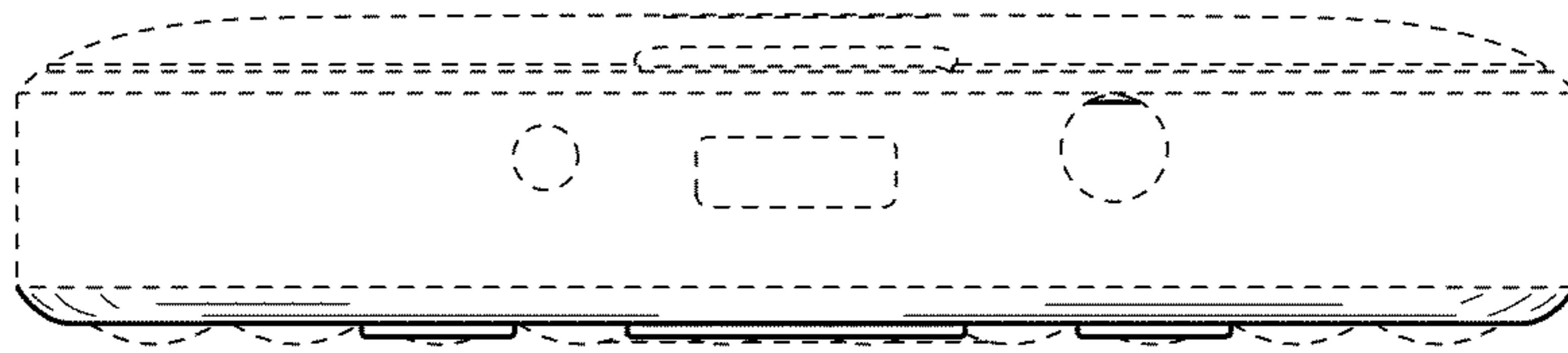
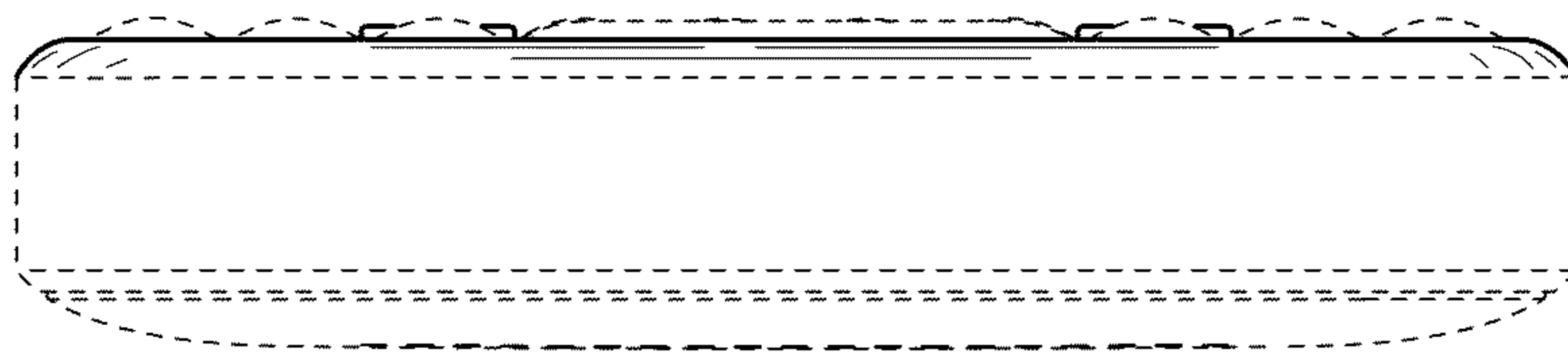

FIG. 5



**FIG. 6**



**FIG. 7**