



US00D719542S

(12) **United States Design Patent**  
**Lee et al.**

(10) **Patent No.:** **US D719,542 S**  
(45) **Date of Patent:** **\*\* Dec. 16, 2014**

(54) **MOBILE PHONE**

(71) Applicant: **Samsung Display Co., Ltd.**, Yongin-si,  
Gyeonggi-do (KR)

(72) Inventors: **Yong-Joon Lee**, Yongin (KR);  
**Woo-Jong Lee**, Yongin (KR)

(73) Assignee: **Samsung Display Co., Ltd.**, Yongin-si  
(KR)

(\*\*) Term: **14 Years**

(21) Appl. No.: **29/448,482**

(22) Filed: **Mar. 12, 2013**

(30) **Foreign Application Priority Data**

Nov. 9, 2012 (KR) ..... 30-2012-0053715

(51) **LOC (10) Cl.** ..... **14-03**

(52) **U.S. Cl.**  
USPC ..... **D14/138 AB; D14/345**

(58) **Field of Classification Search**

CPC ..... H04M 1/0214; H04M 1/0216; H04M  
1/0245; H04M 2250/16; H04M 1/022; G06F  
1/1641; G06F 1/1616  
USPC ..... D14/138 AB, 138 R, 138 AD, 345, 341,  
D14/346, 203.1, 203.4, 203.3, 203.7, 143,  
D14/248, 218, 138 AA, 138 G, 147;  
455/575.1, 556.2, 575.3, 575.4, 566;  
D21/517; 379/433.01, 433.04, 433.12,  
379/433.13; D10/65, 78, 104.1; D13/168;  
361/679.3, 679.56; 345/1.3

See application file for complete search history.

(56) **References Cited**

U.S. PATENT DOCUMENTS

5,808,862 A \* 9/1998 Robbins ..... 361/679.09  
6,072,476 A \* 6/2000 Harada et al. .... 345/204

(Continued)

FOREIGN PATENT DOCUMENTS

KR 10-2010-0092222 A 8/2010  
KR 10-2011-0017858 A 2/2011

OTHER PUBLICATIONS

Sony Tablet P telephone, announced 1Q-2012, [online], [site visited  
Apr. 29, 2014]. Available from Internet, <URL: [http://www.gsmarena.com/sony\\_tablet\\_p-4648.php](http://www.gsmarena.com/sony_tablet_p-4648.php)>.\*

(Continued)

*Primary Examiner* — Jeffrey D Asch

(74) *Attorney, Agent, or Firm* — Christie, Parker & Hale,  
LLP

(57) **CLAIM**

The ornamental design for a mobile phone, as shown and  
described.

**DESCRIPTION**

FIG. 1 is a front perspective view of a mobile phone in a  
closed position;  
FIG. 2 is a front view of the mobile phone of FIG. 1;  
FIG. 3 is a rear view of the mobile phone of FIG. 1;  
FIG. 4 is a left side view of the mobile phone of FIG. 1;  
FIG. 5 is a right side view of the mobile phone of FIG. 1;  
FIG. 6 is a top view of the mobile phone of FIG. 1;  
FIG. 7 is a bottom view of the mobile phone of FIG. 1; and,  
FIG. 8 is a front perspective view of a mobile phone of FIG.  
1 in an open position, wherein the outer panel of the front and  
the two adjacent interior surfaces of the central and rear  
panels as shown in FIGS. 1-7 are oriented in a planar rela-  
tionship.

**1 Claim, 6 Drawing Sheets**

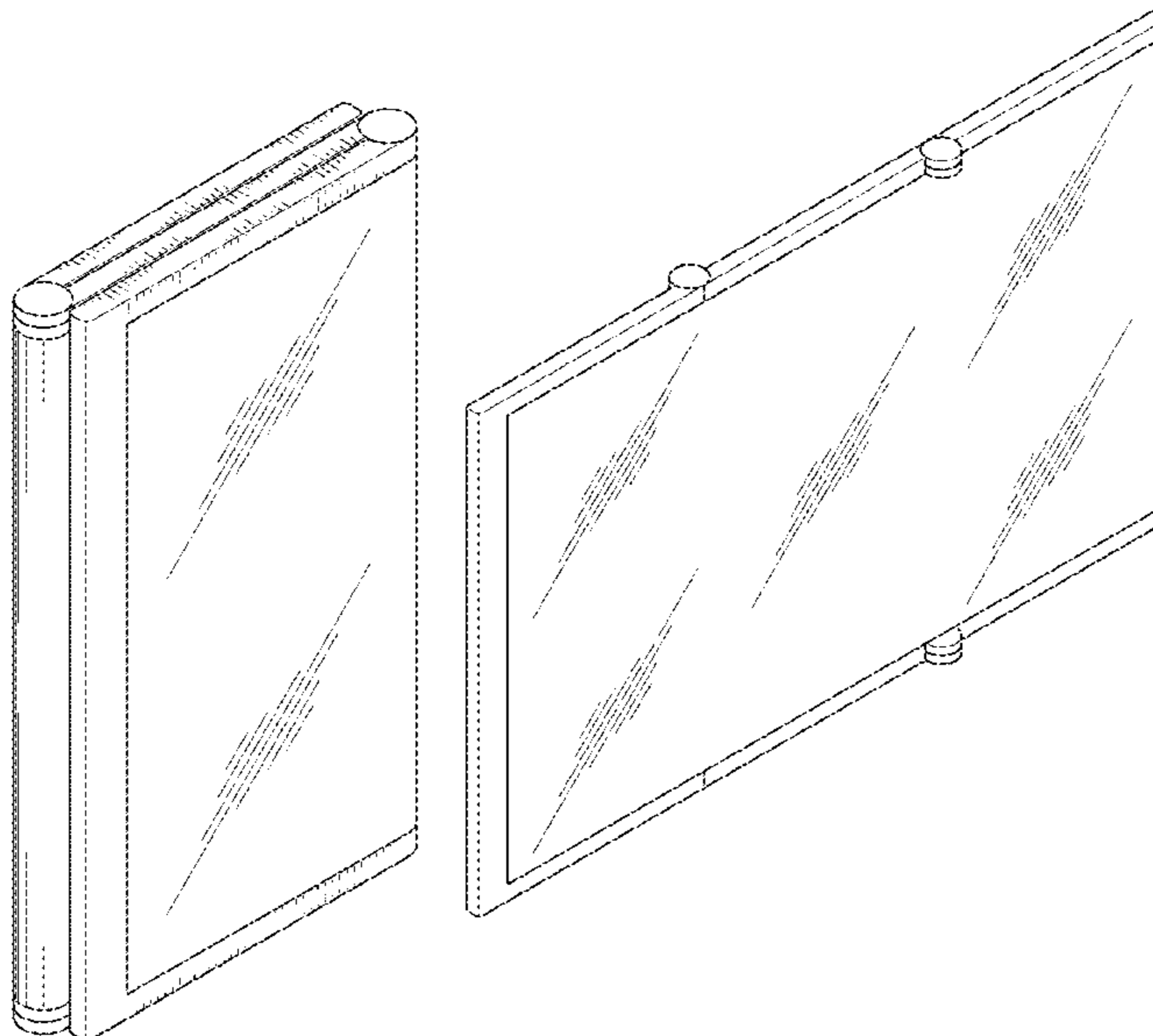

(56)

References Cited

U.S. PATENT DOCUMENTS

6,262,785 B1 \* 7/2001 Kim ..... 349/58  
 7,352,565 B2 \* 4/2008 Yin ..... 361/679.55  
 D585,444 S \* 1/2009 Verschoor ..... D14/345  
 D588,126 S \* 3/2009 Chiang et al. .... D14/345  
 7,714,801 B2 \* 5/2010 Kimmel ..... 345/1.3  
 7,787,917 B2 \* 8/2010 Aoki et al. .... 455/575.3  
 7,864,524 B2 \* 1/2011 Ladouceur et al. .... 361/679.55  
 7,898,501 B2 \* 3/2011 Jang et al. .... 345/1.3  
 8,203,832 B2 \* 6/2012 Szabolcsi ..... 361/679.06  
 8,306,575 B2 \* 11/2012 Kubodera et al. .... 455/566  
 8,330,900 B2 \* 12/2012 Kuo et al. .... 349/73  
 8,355,755 B2 \* 1/2013 Kim et al. .... 455/566  
 8,384,615 B2 \* 2/2013 Tan et al. .... 345/1.1  
 D681,054 S \* 4/2013 Koh et al. .... D14/496  
 8,493,730 B2 \* 7/2013 Shim et al. .... 361/679.55  
 D694,754 S \* 12/2013 Nakada ..... D14/373  
 D696,693 S \* 12/2013 Kim et al. .... D14/496  
 8,670,244 B2 \* 3/2014 Wakimoto ..... 361/755  
 2002/0141146 A1 \* 10/2002 Mustoe ..... 361/683  
 2003/0218860 A1 \* 11/2003 Shiraiwa ..... 361/681  
 2004/0051679 A1 \* 3/2004 Ponx ..... 345/1.1  
 2004/0160736 A1 \* 8/2004 Lin ..... 361/683  
 2005/0134524 A1 \* 6/2005 Parker et al. .... 345/1.1  
 2006/0125784 A1 \* 6/2006 Jang et al. .... 345/156  
 2007/0004475 A1 \* 1/2007 Kuo et al. .... 455/575.3  
 2008/0062625 A1 \* 3/2008 Batio ..... 361/680

2008/0079656 A1 \* 4/2008 Kee et al. .... 345/1.3  
 2010/0064244 A1 \* 3/2010 Kilpatrick et al. .... 715/773  
 2010/0201604 A1 8/2010 Kee et al.  
 2011/0148797 A1 6/2011 Huitema et al.  
 2011/0241998 A1 \* 10/2011 McKinney et al. .... 345/168  
 2012/0236484 A1 \* 9/2012 Miyake ..... 361/679.01  
 2013/0082924 A1 \* 4/2013 Kumar et al. .... 345/157  
 2013/0100040 A1 \* 4/2013 Haynes et al. .... 345/173  
 2013/0135837 A1 \* 5/2013 Kemppinen ..... 361/807  
 2013/0250492 A1 \* 9/2013 Wong et al. .... 361/679.01  
 2013/0321340 A1 \* 12/2013 Seo et al. .... 345/174

OTHER PUBLICATIONS

Plica Concept Phone is Two Times the iPhone, by Thyrstan, concept-phones.com, posted Aug. 4, 2008, [online], [site visited May 12, 2014]. Available from Internet, <URL: <http://www.concept-phones.com/cool-concepts/plica-concept-phone-is-two-times-the-iphone/>>.\*  
 Flexible Silicon Phone“Plica”, by Kenny-J. t-device.net, posted Jul. 4, 2011, [online], [site visited May 12, 2014]. Available from Internet, <URL: <http://tdevice.net/flexible-silicon-phone-plica/>>.\*  
 CES 09: Samsung Folding OLED Display, by reghardware, posted Jan 8, 2009, youtube, [online], [site visited May 12, 2014]. Available from Internet, <URL: [https://www.youtube.com/watch?v=YfN\\_TkZUOt4](https://www.youtube.com/watch?v=YfN_TkZUOt4)>.\*

\* cited by examiner

FIG. 1

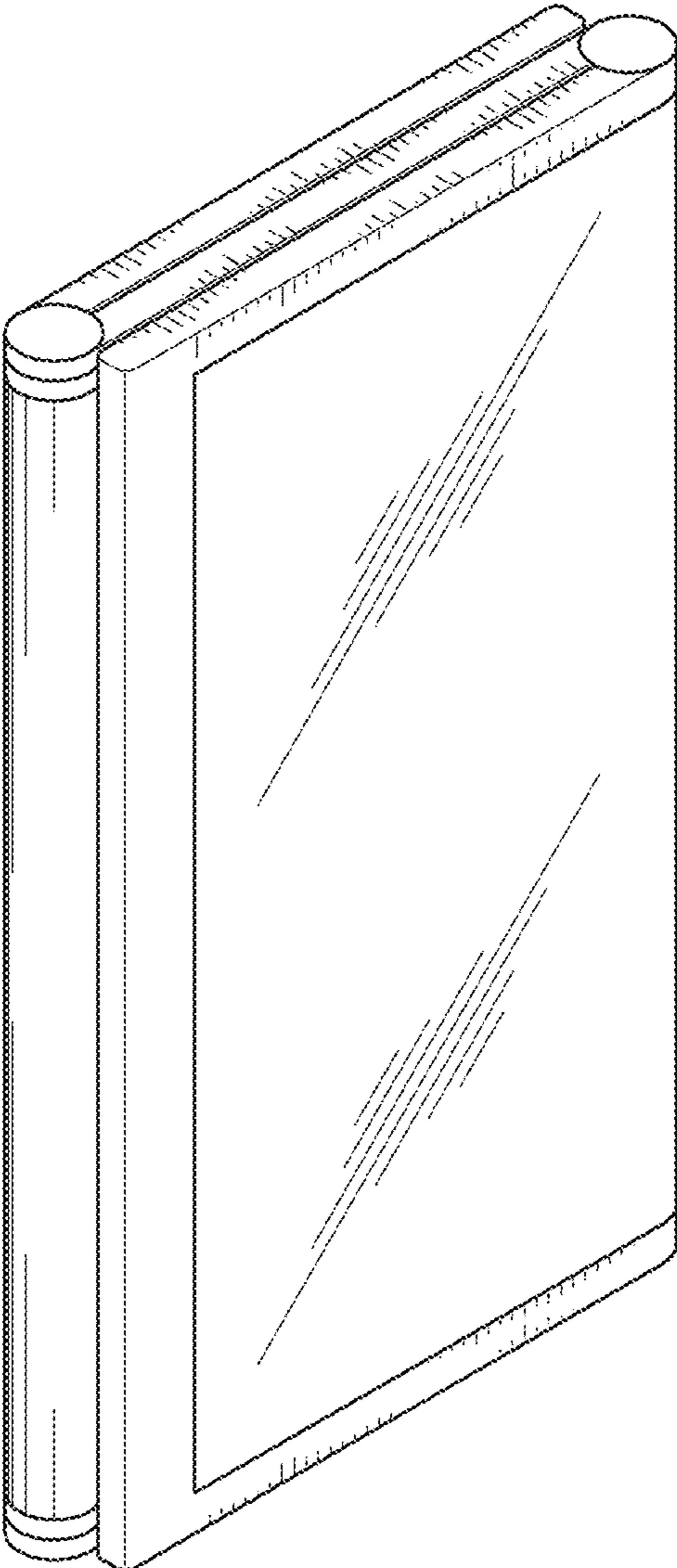

FIG. 2

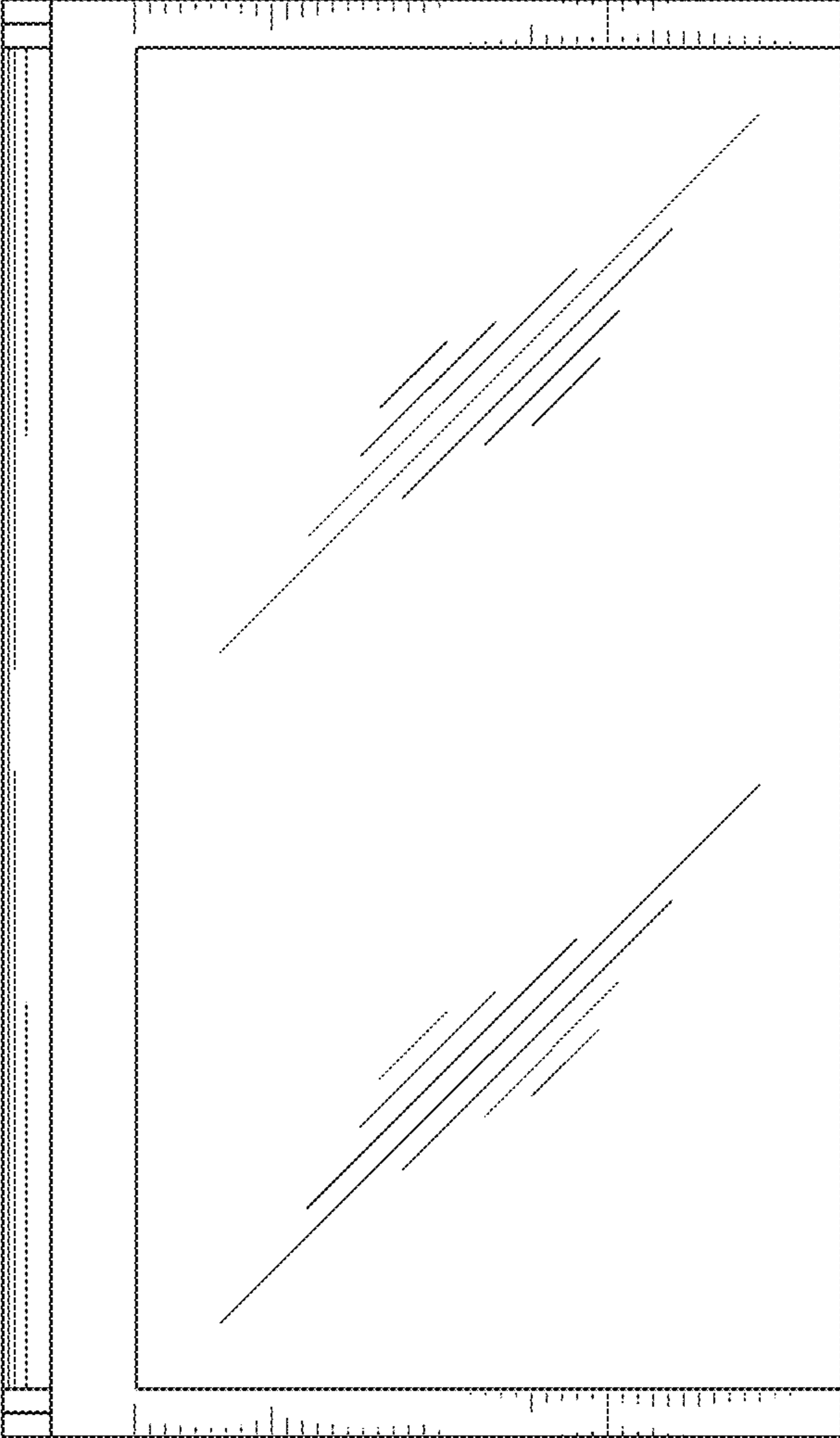

FIG. 3

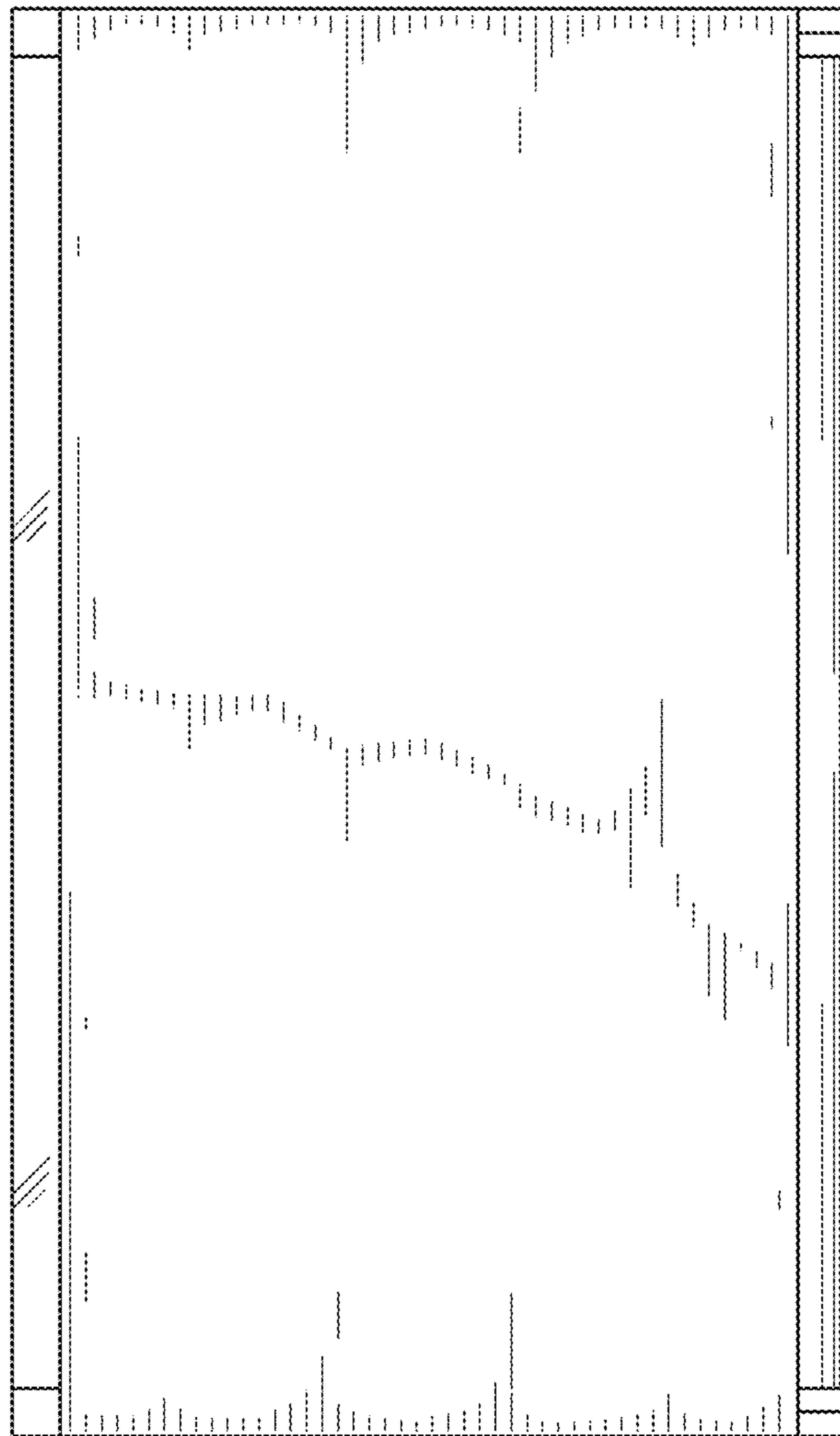



FIG. 4

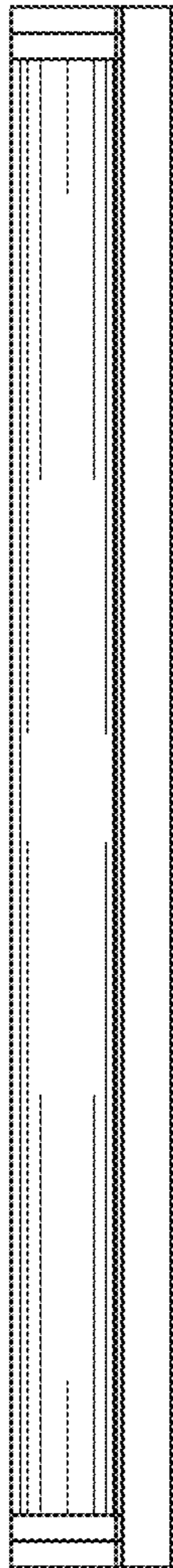

FIG. 5

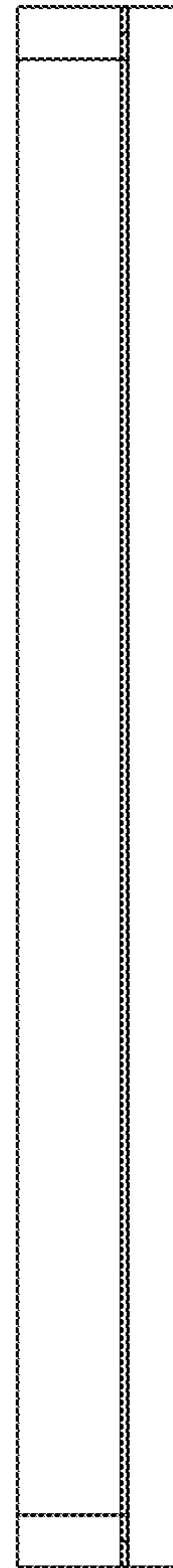

FIG. 6

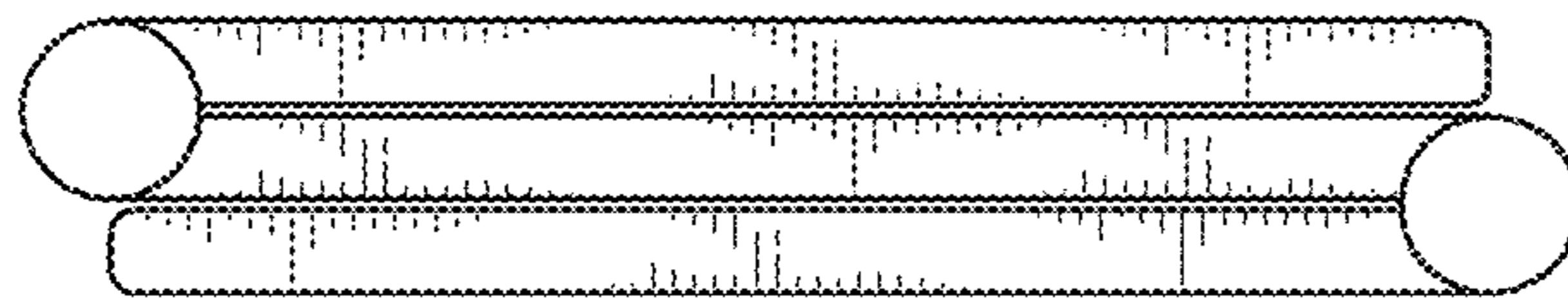

FIG. 7

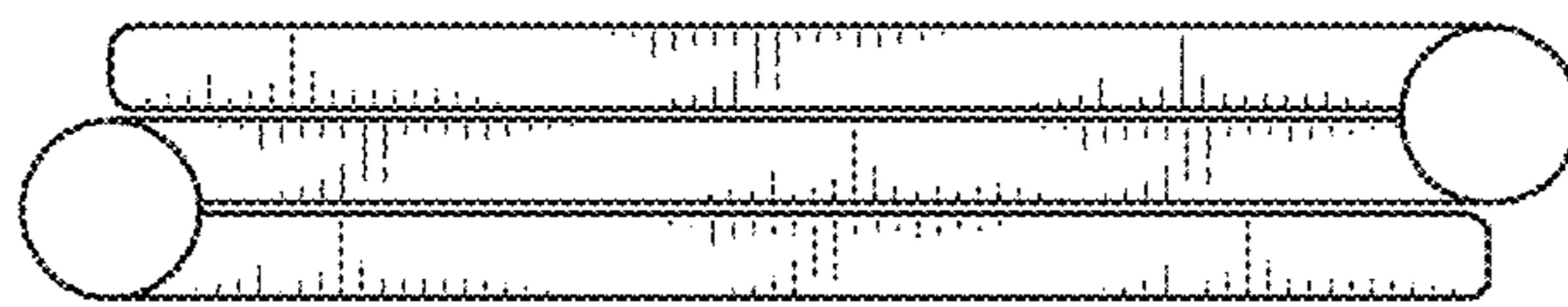

FIG. 8

