



US00D719487S

(12) **United States Design Patent**
Asai et al.

(10) **Patent No.:** **US D719,487 S**
(45) **Date of Patent:** **** Dec. 16, 2014**

(54) **AUTOMOBILE, TOY REPLICA AND/OR
OTHER REPLICAS**

(71) Applicant: **Honda Motor Co., Ltd.**, Tokyo (JP)

(72) Inventors: **Keisuke Asai**, Wako (JP); **Akihiko
Ohhashi**, Wako (JP)

(73) Assignee: **Honda Motor Co., Ltd.**, Tokyo (JP)

(**) Term: **14 Years**

(21) Appl. No.: **29/468,758**

(22) Filed: **Oct. 2, 2013**

(30) **Foreign Application Priority Data**

Apr. 9, 2013 (JP) 2013-007892

(51) **LOC (10) Cl.** **12-08**

(52) **U.S. Cl.**
USPC **D12/91**

(58) **Field of Classification Search**
CPC B62D 35/00
USPC D12/86, 90-92; D21/421, 433, 434;
296/181.1, 181.5
See application file for complete search history.

(56) **References Cited**

U.S. PATENT DOCUMENTS

D604,670 S * 11/2009 Nagura et al. D12/91
D619,500 S * 7/2010 Hsu et al. D12/91

D630,554 S * 1/2011 Kim D12/91
D633,823 S * 3/2011 Matei et al. D12/91
D647,004 S * 10/2011 Nemoto D12/91
D657,715 S * 4/2012 Hakamata et al. D12/91
D666,945 S * 9/2012 Ogawa et al. D12/91
D674,726 S * 1/2013 Yamada et al. D12/91
D692,346 S * 10/2013 Matsueda D12/91
D697,834 S * 1/2014 Okue et al. D12/91
D699,628 S * 2/2014 Kochi et al. D12/91
D709,800 S * 7/2014 Cartabiano et al. D12/91

* cited by examiner

Primary Examiner — Melody N Brown

(74) *Attorney, Agent, or Firm* — Plumsea Law Group, LLC

(57) **CLAIM**

The ornamental design for an automobile, toy replica and/or other replicas, as shown and described.

DESCRIPTION

FIG. 1 is a front perspective view of an automobile, toy replica and/or other replicas.
FIG. 2 is a rear perspective view thereof.
FIG. 3 is a right side elevation view thereof.
FIG. 4 is a left side elevation view thereof.
FIG. 5 is a front elevation view thereof.
FIG. 6 is a rear elevation view thereof; and,
FIG. 7 is a top plan view thereof.
The portions of the automobile shown in broken lines are for the purpose of showing environmental structure only and form no part of the claimed design.

1 Claim, 7 Drawing Sheets

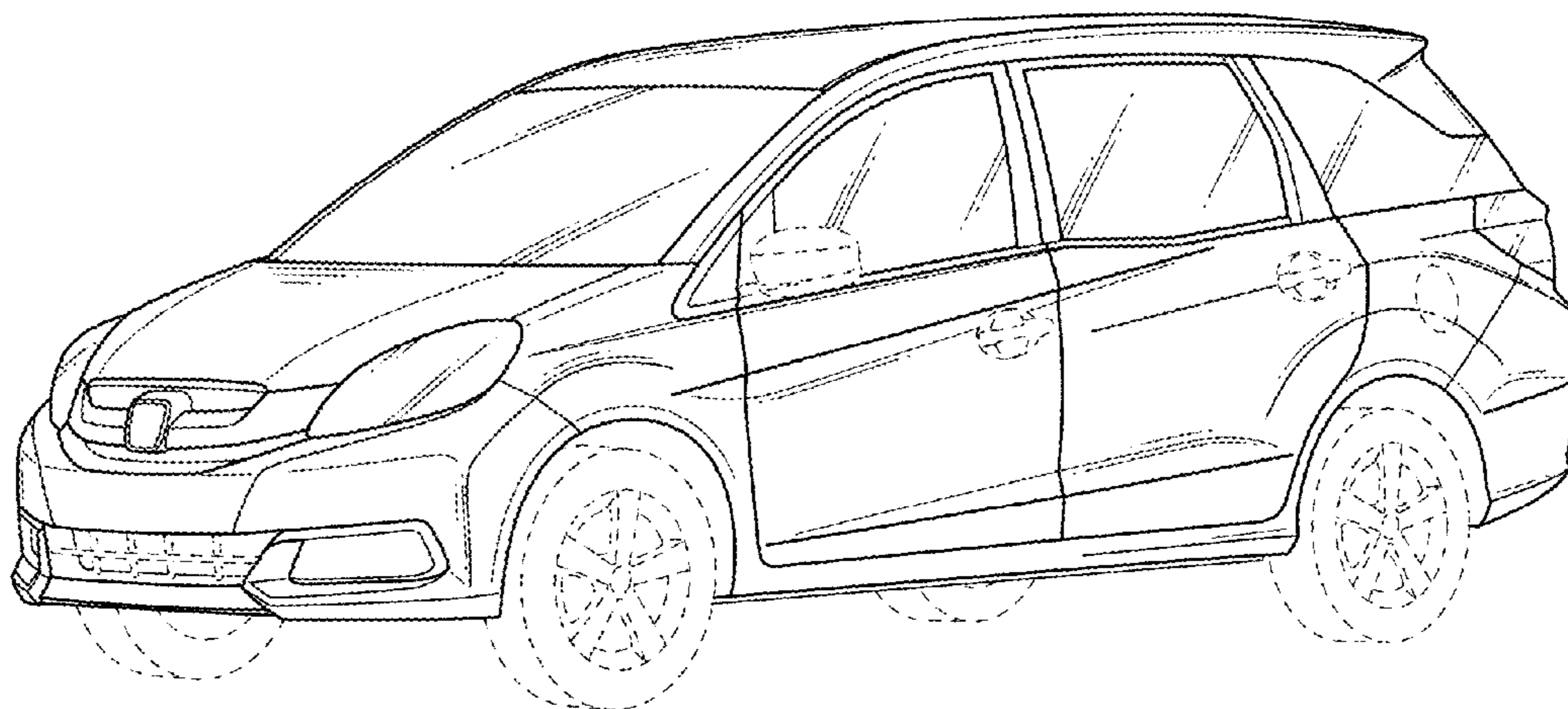

FIG. 1

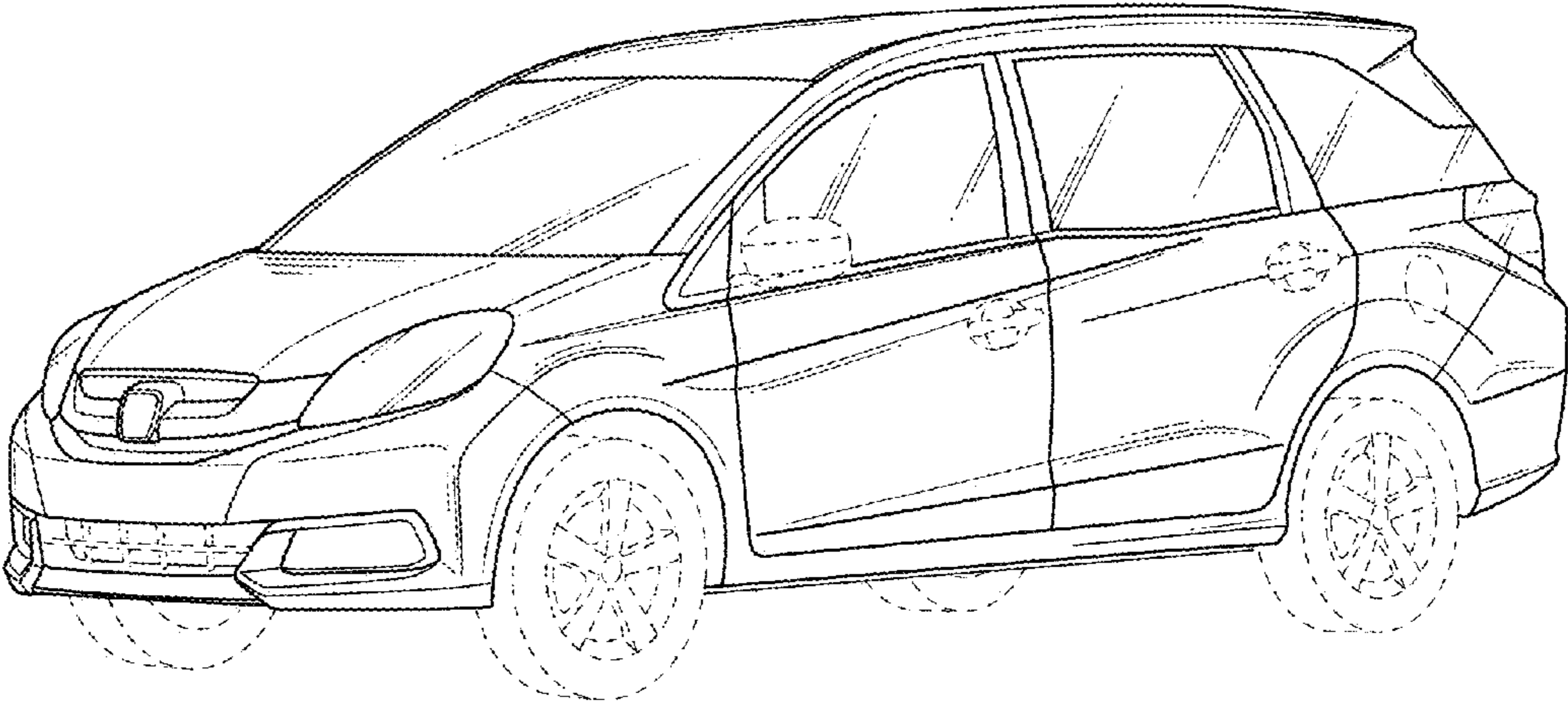

FIG. 2

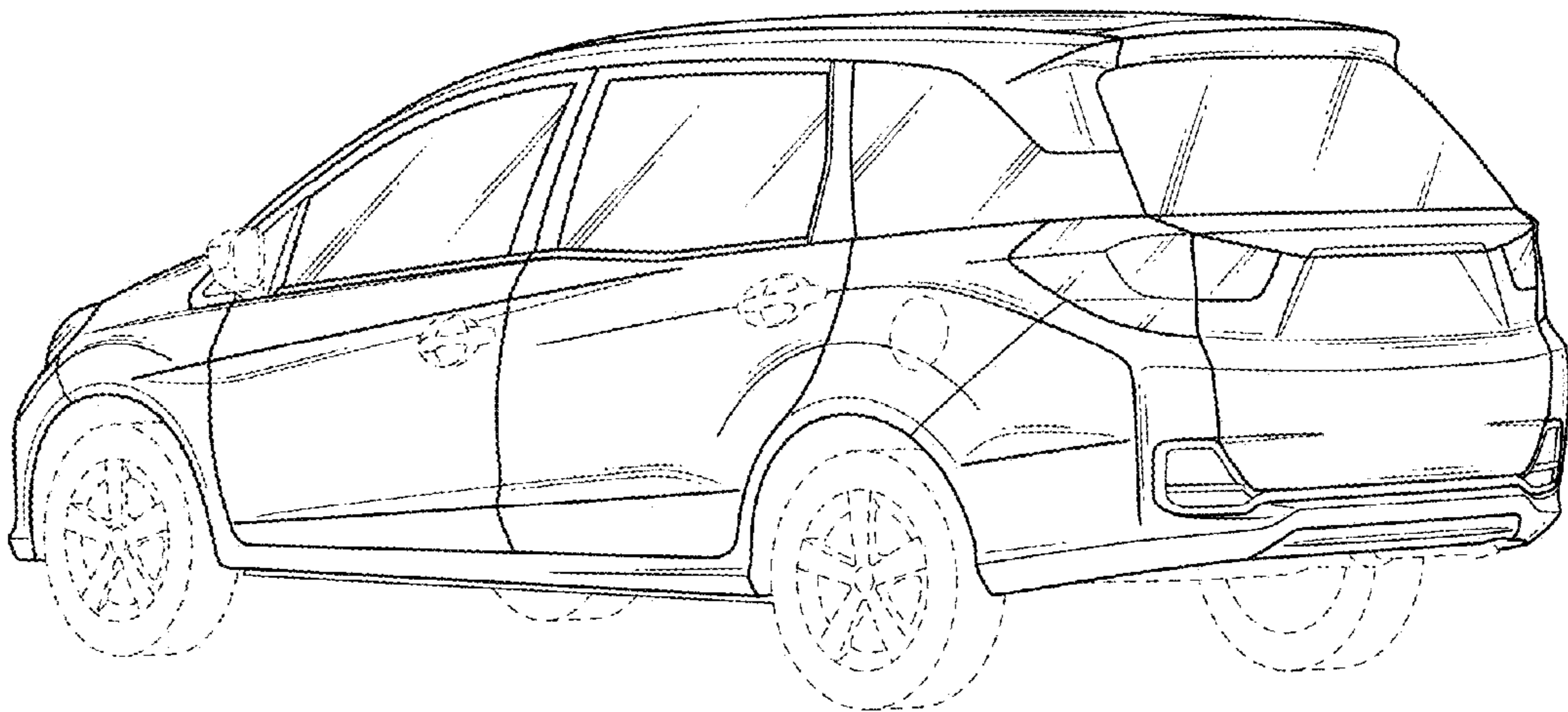

FIG. 3

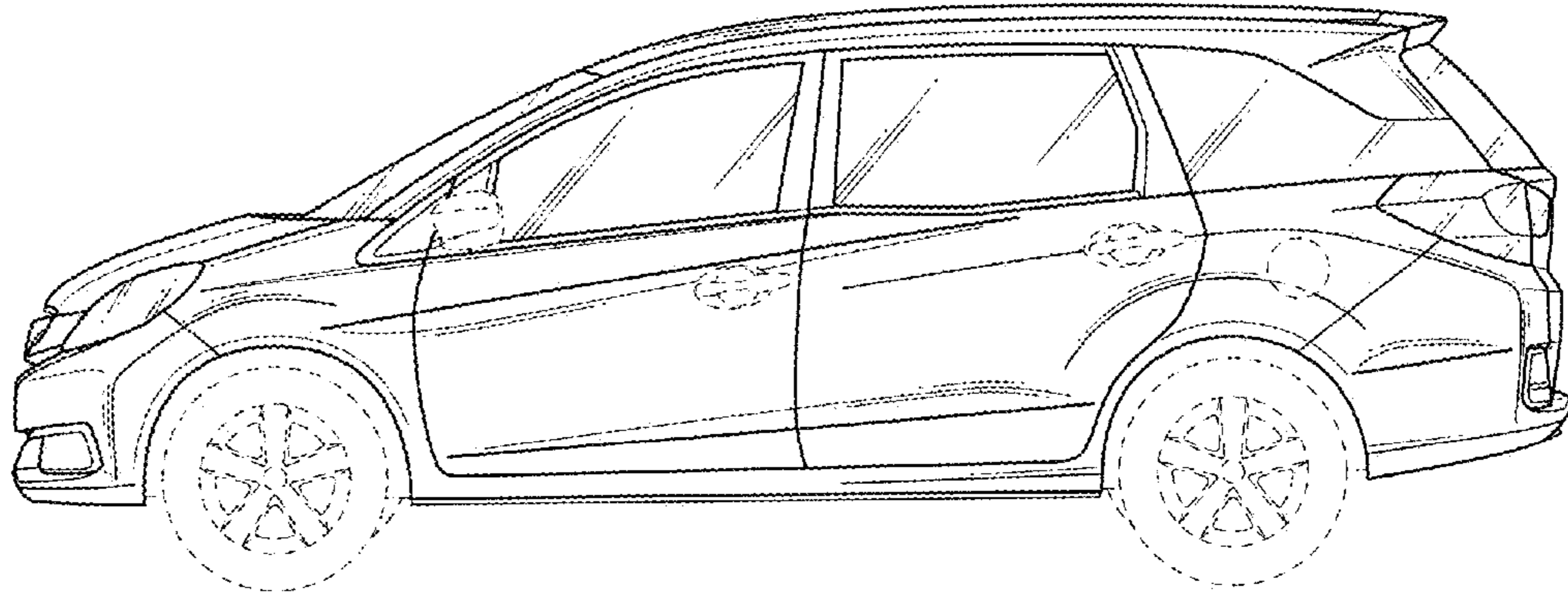

FIG. 4

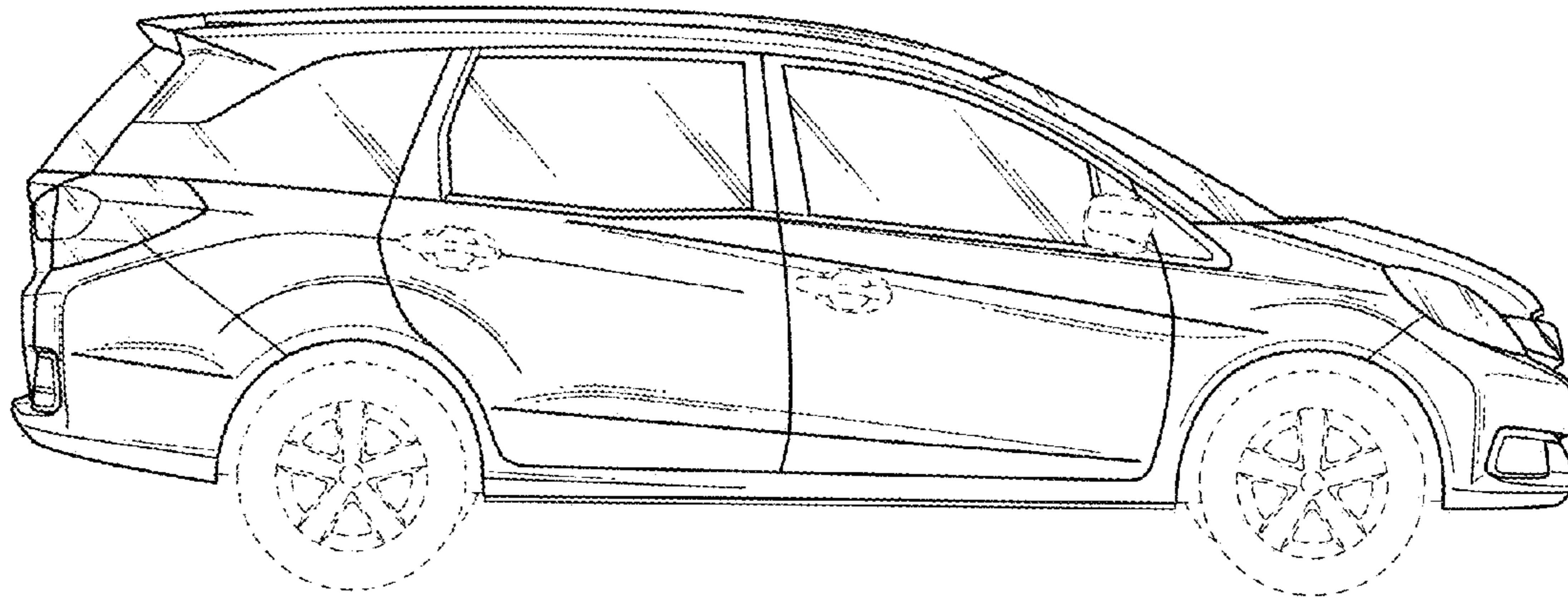

FIG. 5

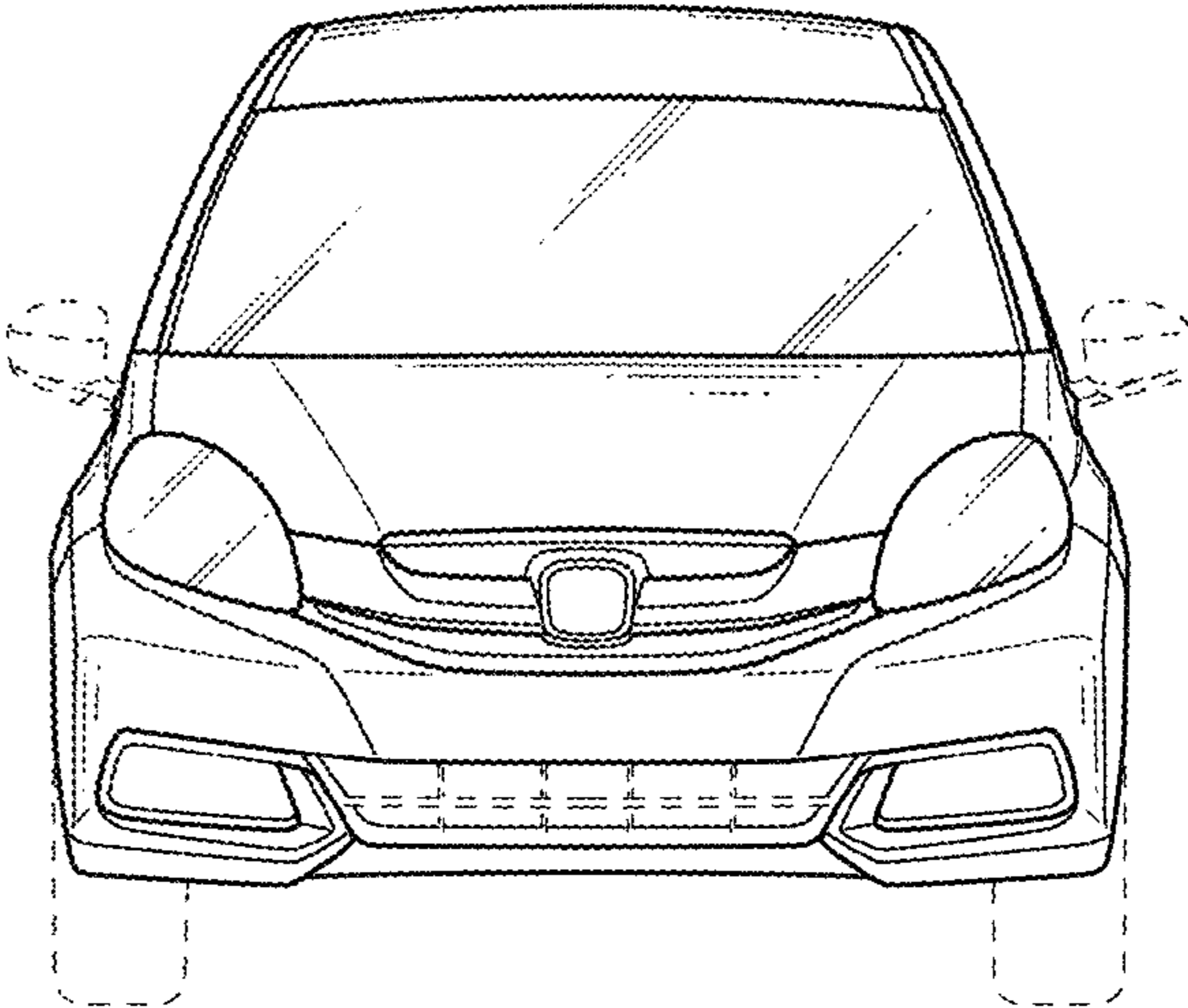

FIG. 6

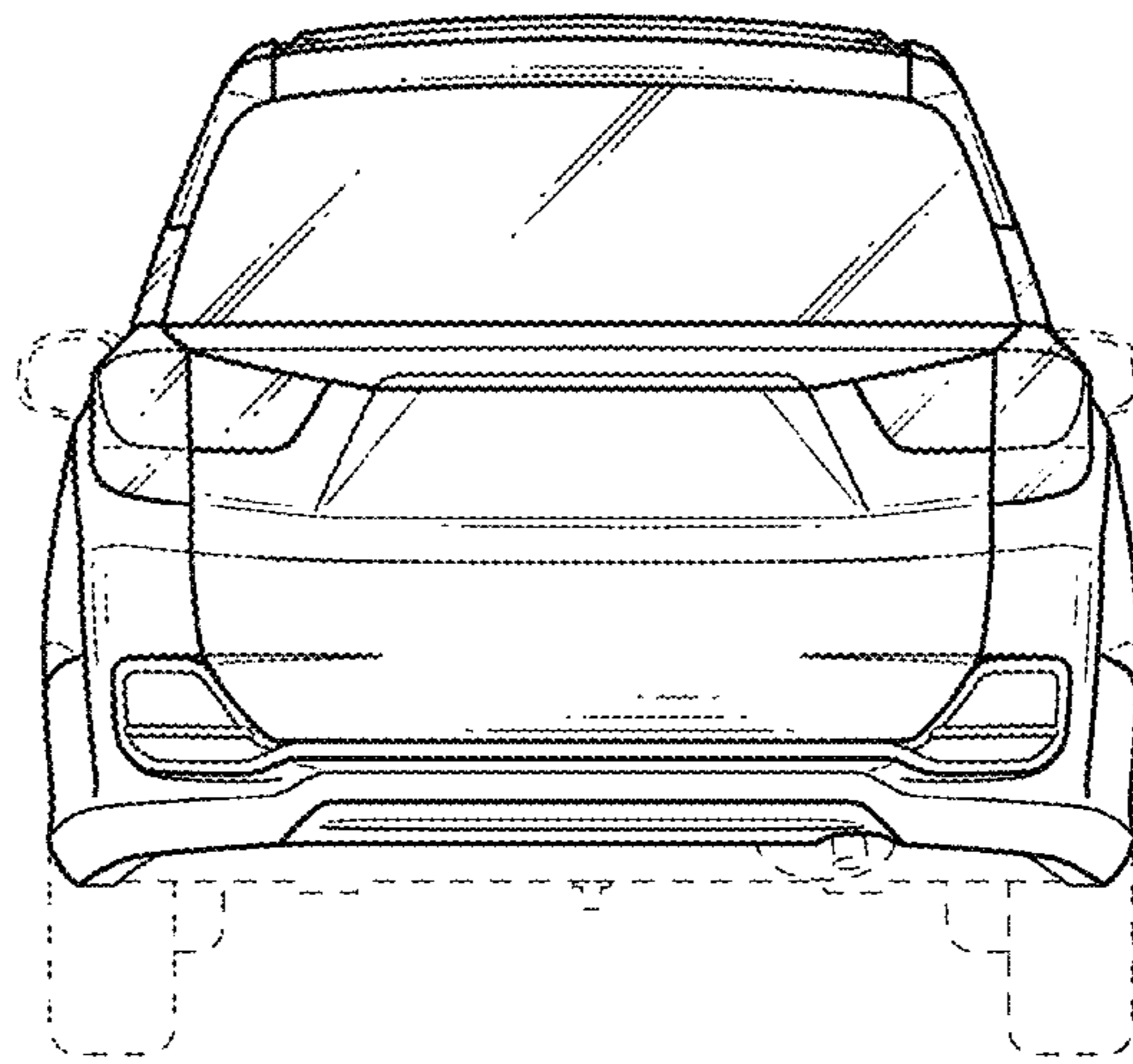

FIG. 7

