



US00D719389S

(12) **United States Design Patent**  
**Wimsatt**

(10) **Patent No.:** **US D719,389 S**

(45) **Date of Patent:** **\*\* \*Dec. 16, 2014**

(54) **SUGAR DISPENSING COFFEE MAKER**

(71) Applicant: **John Wimsatt**, Minden, LA (US)

(72) Inventor: **John Wimsatt**, Minden, LA (US)

(\*) Notice: This patent is subject to a terminal disclaimer.

(\*\*) Term: **14 Years**

(21) Appl. No.: **29/434,524**

(22) Filed: **Oct. 12, 2012**

(51) **LOC (10) Cl.** ..... **07-01**

(52) **U.S. Cl.**  
USPC ..... **D7/305**; D7/311; D7/309

(58) **Field of Classification Search**  
USPC ..... D7/306, 309-311, 300, 313, 301, 307,  
D7/308, 305, 589; 99/323.2, 284, 279,  
99/302, 294, 290, 295; 222/146.6, 185.1  
See application file for complete search history.

(56) **References Cited**

**U.S. PATENT DOCUMENTS**

2,761,200 A 9/1956 Arnett  
2,953,171 A 9/1960 Arnett et al.  
3,194,147 A 7/1965 Cowley

D336,015 S \* 6/1993 Guzewicz ..... D7/589  
D355,562 S \* 2/1995 DeFelip ..... D7/309  
5,611,262 A \* 3/1997 Rizzuto et al. .... 99/294  
D424,361 S \* 5/2000 Kuboyama ..... D7/309  
D528,845 S \* 9/2006 Zimmermann ..... D7/309  
D568,665 S \* 5/2008 Tonelli ..... D7/309  
D583,610 S \* 12/2008 Lam ..... D7/309  
D605,454 S \* 12/2009 Nicolini ..... D7/306  
2008/0017042 A1 1/2008 Almlad et al.

\* cited by examiner

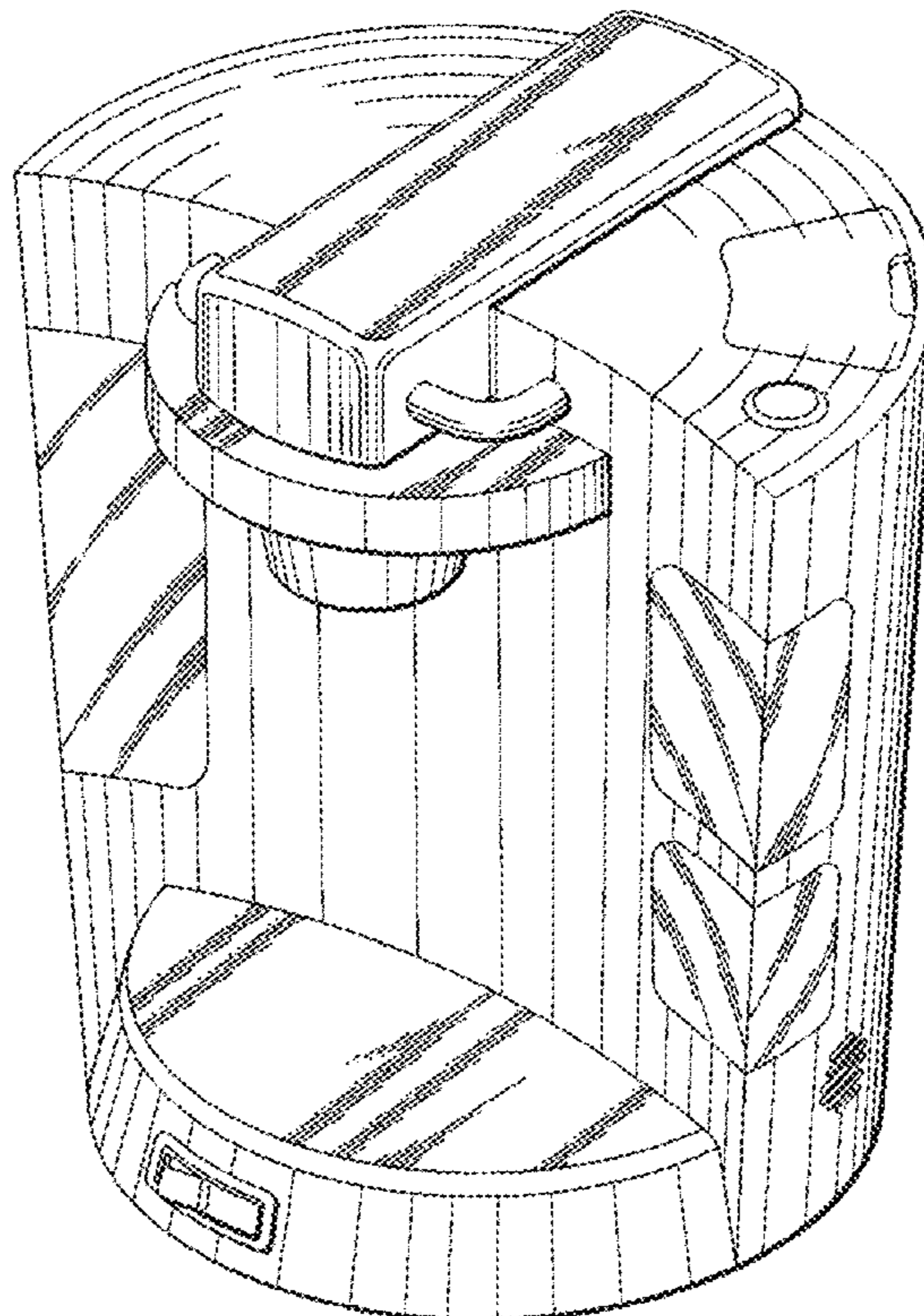
*Primary Examiner* — Marianne Pandozzi  
(74) *Attorney, Agent, or Firm* — RG Patent Consulting LLC

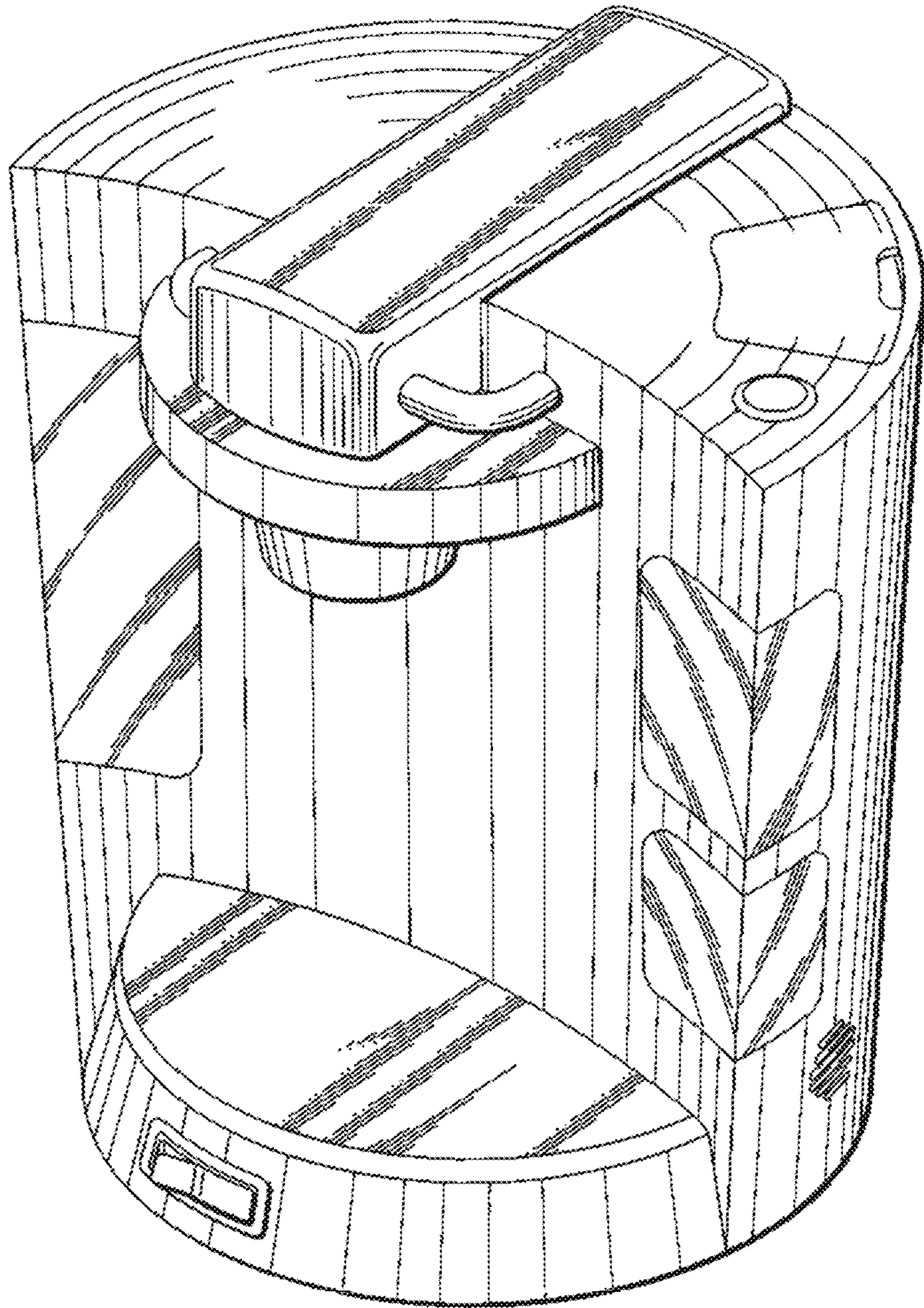
(57) **CLAIM**  
I claim the ornamental design for a sugar dispensing coffee maker, as shown and described.

**DESCRIPTION**

FIG. 1 is a front, top and side perspective view of the sugar dispensing coffee maker embodying the design of the present invention.  
FIG. 2 is a front elevational view thereof.  
FIG. 3 is a side elevational view thereof.  
FIG. 4 is a side elevational view thereof showing the side opposite to the side shown in FIG. 3.  
FIG. 5 is a top plan view thereof; and,  
FIG. 6 is a rear elevational view thereof.

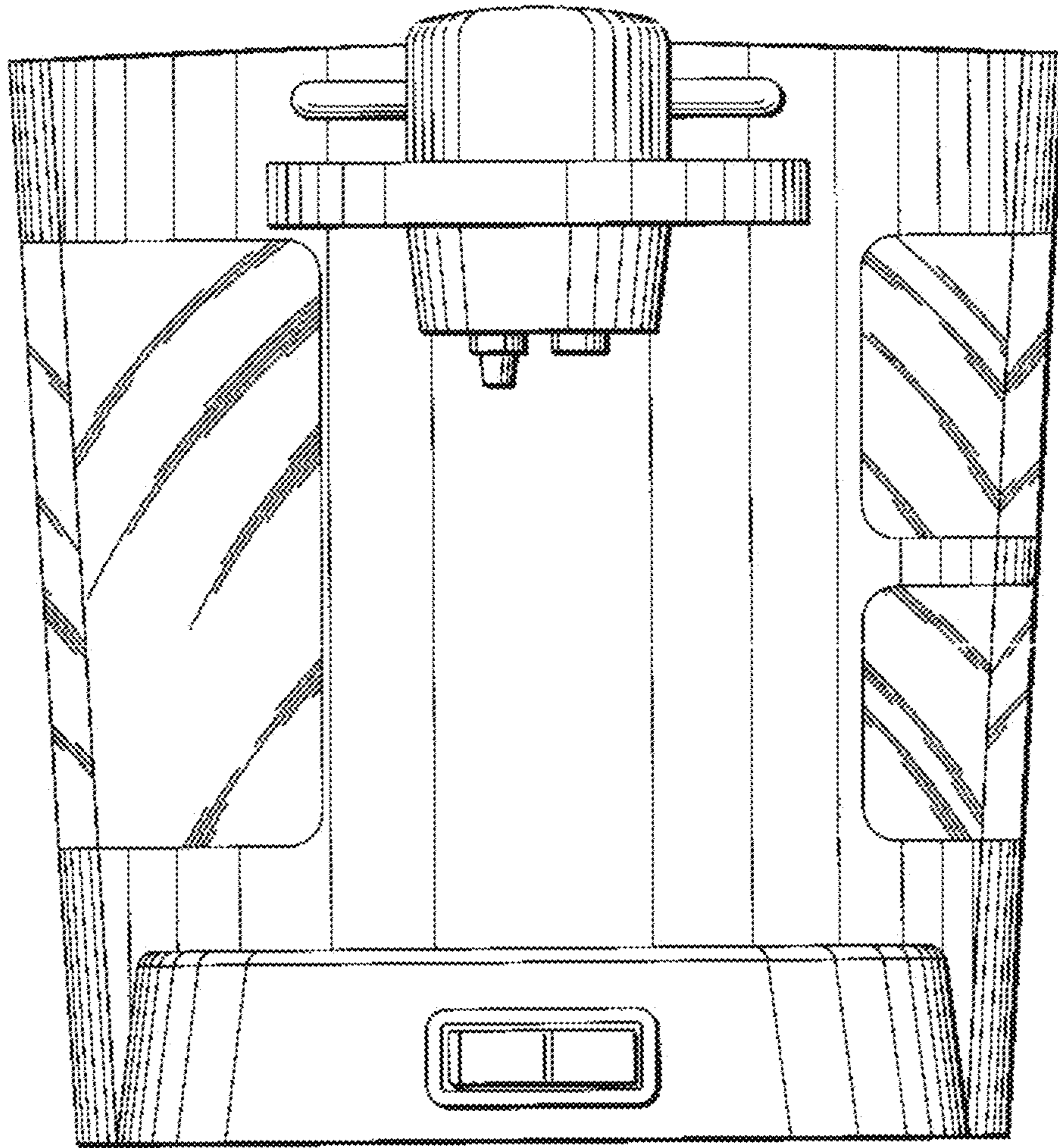
**1 Claim, 6 Drawing Sheets**



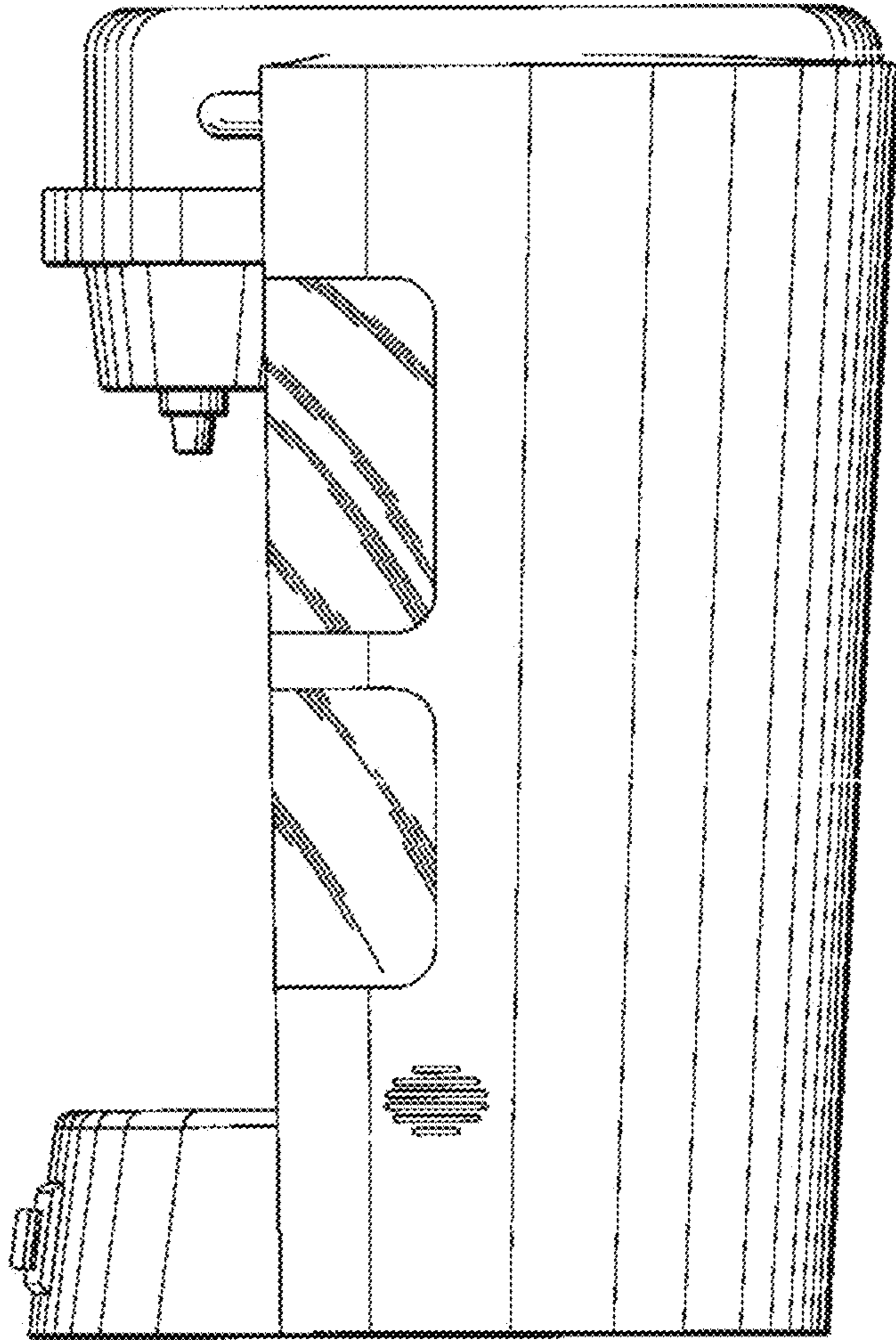


*Fig. 1*

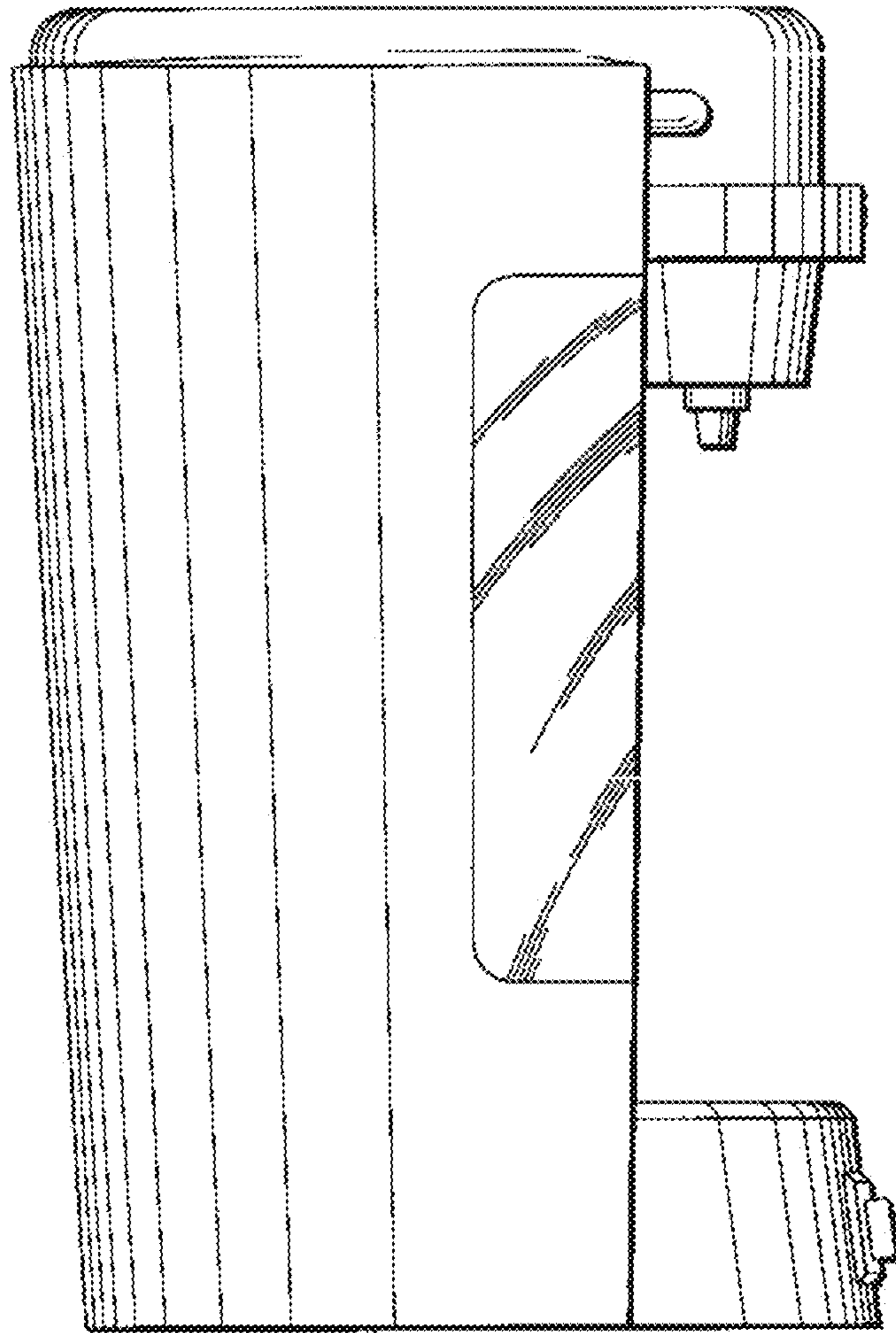




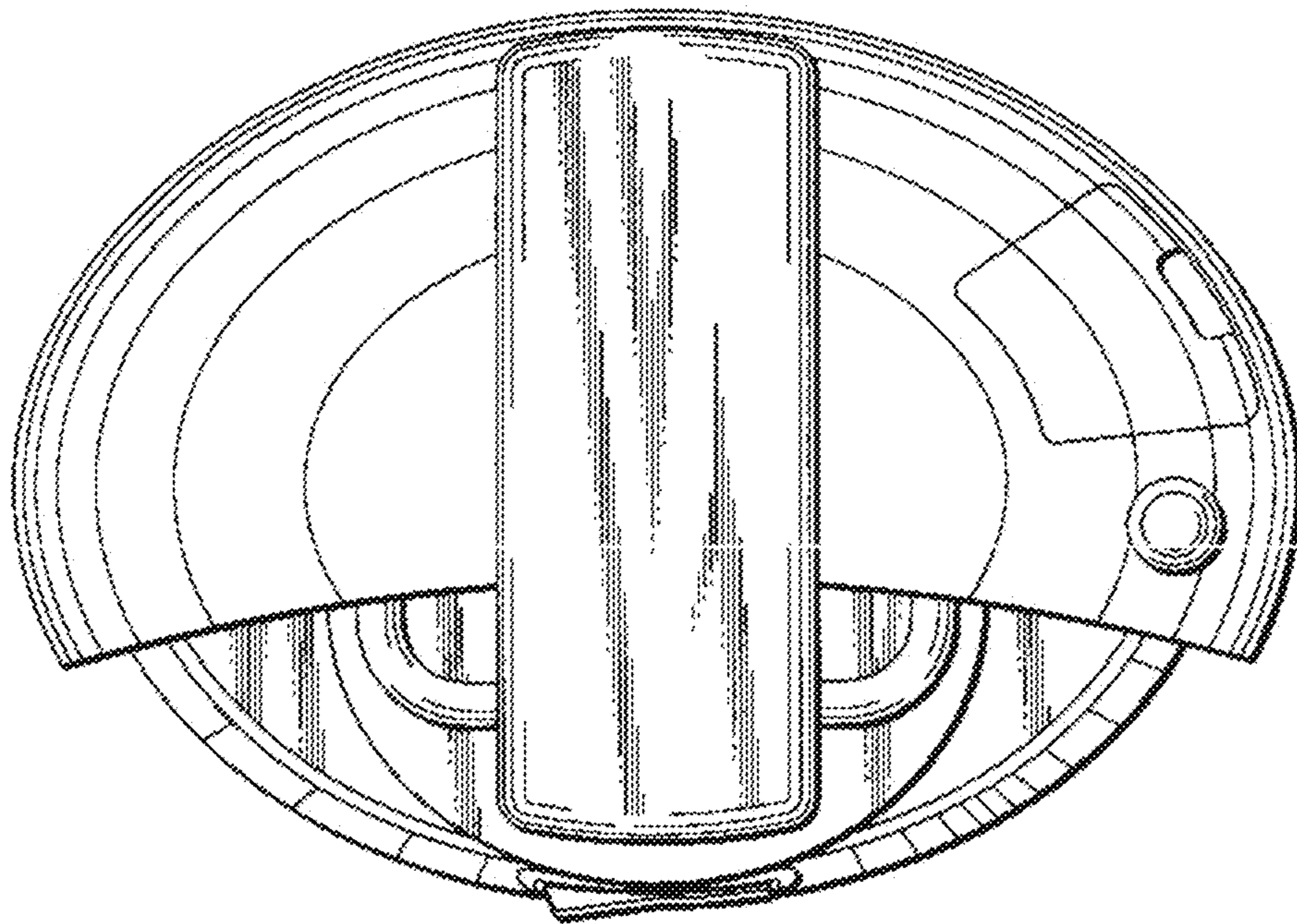
*Fig. 2*



*Fig. 3*

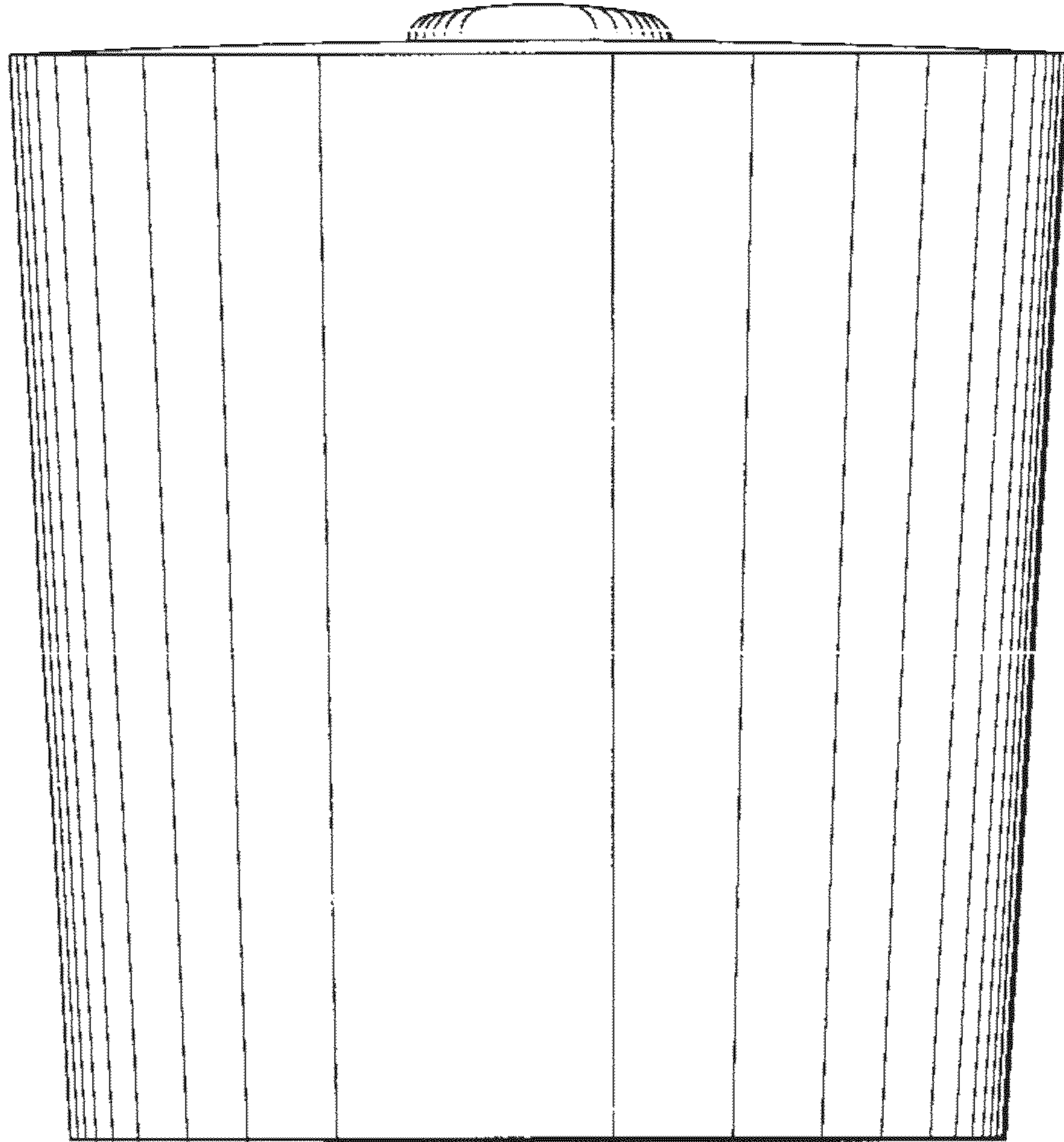


*Fig. 4*



*Fig. 5*





*Fig. 6*