



US00D719347S

(12) **United States Design Patent**  
**Newton**

(10) **Patent No.:** **US D719,347 S**  
(45) **Date of Patent:** **\*\* Dec. 16, 2014**

- (54) **SECURE CELL PHONE HOLDER**
- (71) Applicant: **Giddy Up, LLC**, Roswell, GA (US)
- (72) Inventor: **Joanna G. Newton**, Roswell, GA (US)
- (73) Assignee: **Giddy Up, LLC**, Roswell, GA (US)
- (\*\*) Term: **14 Years**
- (21) Appl. No.: **29/479,504**
- (22) Filed: **Jan. 16, 2014**
- (51) **LOC (10) Cl.** ..... **03-01**
- (52) **U.S. Cl.**  
USPC ..... **D3/218**
- (58) **Field of Classification Search**  
USPC ..... D3/218, 219, 215, 201, 224, 226, 228,  
D3/269, 303; 224/240–241, 245, 578, 674,  
224/676–681, 901, 904; 206/305, 320;  
455/575.1–575.8; D14/248, 250–251,  
D14/253; 379/455  
See application file for complete search history.

- 6,651,854 B1 11/2003 LaCoste
- 6,695,022 B2 2/2004 Morehead
- 6,698,636 B2 3/2004 Angus et al.
- D490,238 S 5/2004 Bristel
- 6,883,694 B2 4/2005 Abelow
- D541,042 S 4/2007 Andre et al.
- D553,853 S 10/2007 Willows et al.
- D599,108 S 9/2009 Brandenburg
- 8,157,140 B2 4/2012 Jay
- D666,409 S 9/2012 Andre et al.

(Continued)

**OTHER PUBLICATIONS**

Newton, Joanna G.; U.S. Provisional Application Entitled: Secure, Bounce-Free, Waterproof Cell Phone Holder for Athletes, Specifically Equestrians, U.S. Appl. No. 61/833,035, filed Jun. 10, 2013; 10 pgs.

(Continued)

*Primary Examiner* — Catheri Oliver-Garcia  
(74) *Attorney, Agent, or Firm* — Taylor English Duma LLP

(57) **CLAIM**

I claim the ornamental design for a secure cell phone holder, as shown and described.

**DESCRIPTION**

FIG. 1 is a perspective view of the claimed design.  
FIG. 2 is a front elevation view thereof.  
FIG. 3 is a back elevation view thereof.  
FIG. 4 is a left-side elevation view thereof.  
FIG. 5 is a right-side elevation view thereof.  
FIG. 6 is a top plan view thereof.  
FIG. 7 is a bottom plan view thereof; and,  
FIG. 8 is a perspective view of the secure cell phone holder worn on the waist of a user.  
The broken line drawing of a user shown in FIG. 8 shows environmental use of the claimed design only and forms no part of the claimed design.

**1 Claim, 6 Drawing Sheets**

(56) **References Cited**

**U.S. PATENT DOCUMENTS**

- 2,474,495 A 6/1949 Pollack
- 4,905,857 A 3/1990 Her
- 5,285,833 A 2/1994 Haxby
- 5,353,975 A 10/1994 Libertucci
- 5,511,704 A 4/1996 Linderer
- 5,540,366 A 7/1996 Coomber
- 5,551,496 A 9/1996 Gray
- 5,645,205 A 7/1997 Kennedy
- 5,775,561 A 7/1998 Kennedy
- 5,878,441 A 3/1999 Busker et al.
- 6,076,789 A 6/2000 Jackson
- D439,040 S 3/2001 Vazquez
- D440,762 S 4/2001 Sherman
- D446,928 S \* 8/2001 Formica ..... D3/218
- 6,435,392 B1 8/2002 Kennedy
- 6,473,941 B2 11/2002 Mei et al.

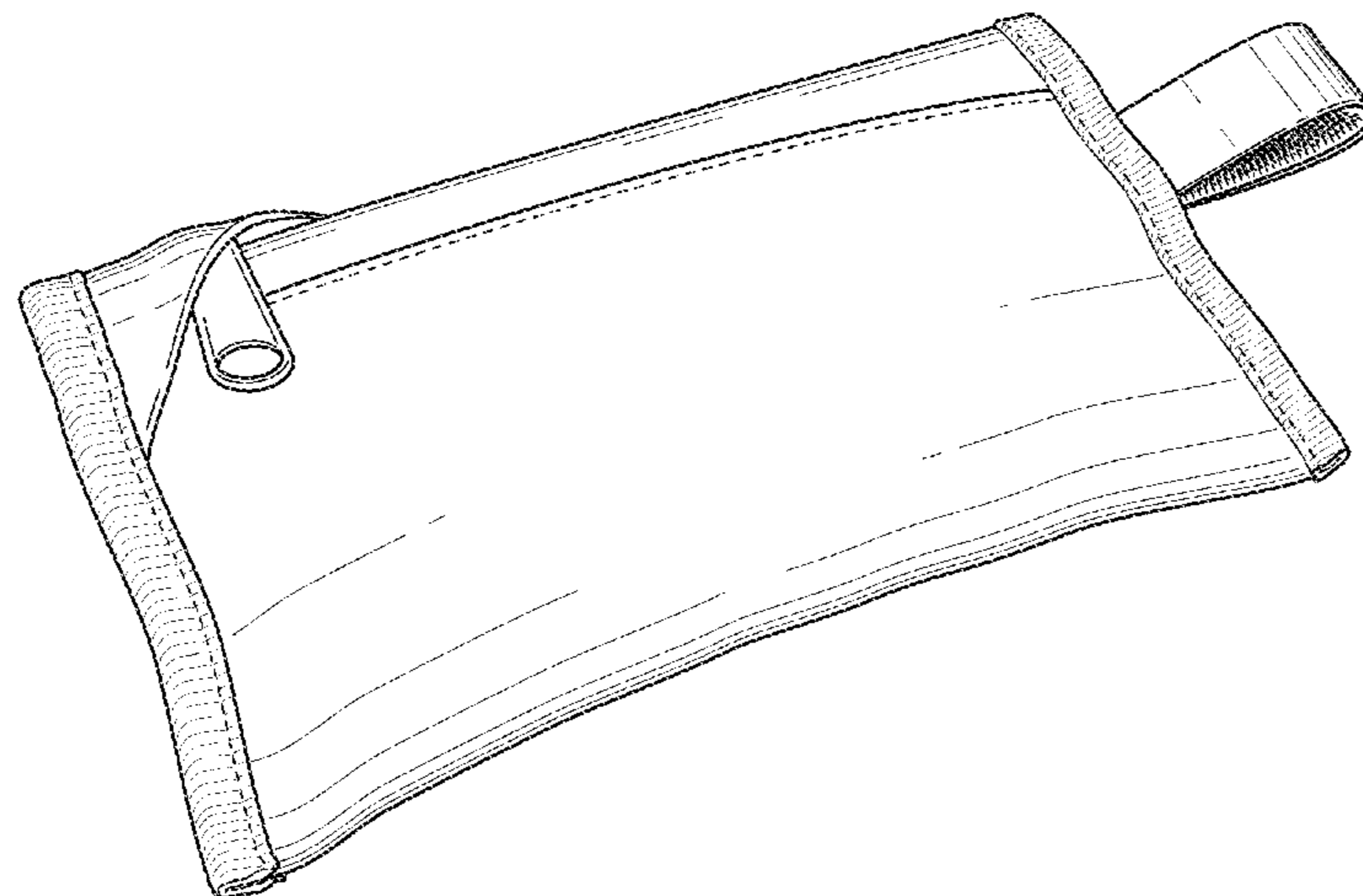

(56)

**References Cited**

U.S. PATENT DOCUMENTS

D669,260	S	10/2012	Davidson	
D676,232	S	2/2013	Manning et al.	
D681,945	S	5/2013	Willows et al.	
8,474,669	B2	7/2013	Rohrbach et al.	
D691,794	S *	10/2013	Curran-Blaney et al.	D3/218
D692,230	S *	10/2013	Phillips et al.	D3/218
D695,007	S *	12/2013	Zhang	D3/218
2005/0017040	A1	1/2005	Roberts et al.	
2007/0215663	A1	9/2007	Chongson et al.	
2011/0226831	A1	9/2011	Crifasi	

OTHER PUBLICATIONS

Newton, Joanna G.; U.S. Patent Application entitled: Secure Cell Phone Holder, U.S. Appl. No. 14/228,343, filed Mar. 28, 2014; 25 pgs.  
Smartpak; "Cell Phone Holder", located at <<http://www.smartpakeguine.com/cell-phone-holder-9501p>> (Accessed Sep. 10, 2013), 4 pgs.  
Jaminleather.com; "Large Flap Top iPod & Smart Phone Case"; located at <<http://www.jaminleather.com/Large-Flap-Top-iPod-Smart-Phone-Case-P2364.aspx>> (Accessed Sep. 10, 2013), 2 pgs.

\* cited by examiner

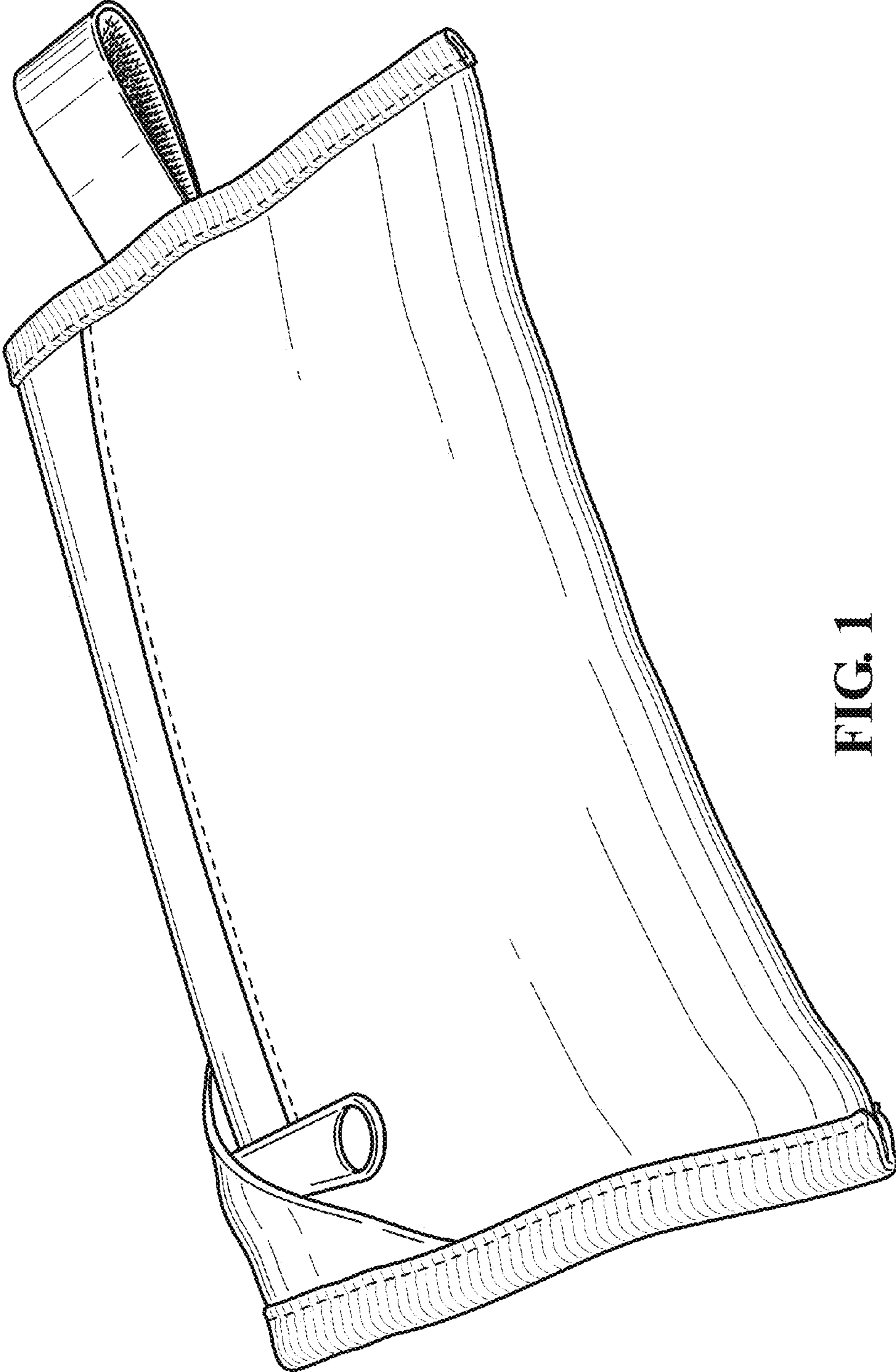

FIG. 1

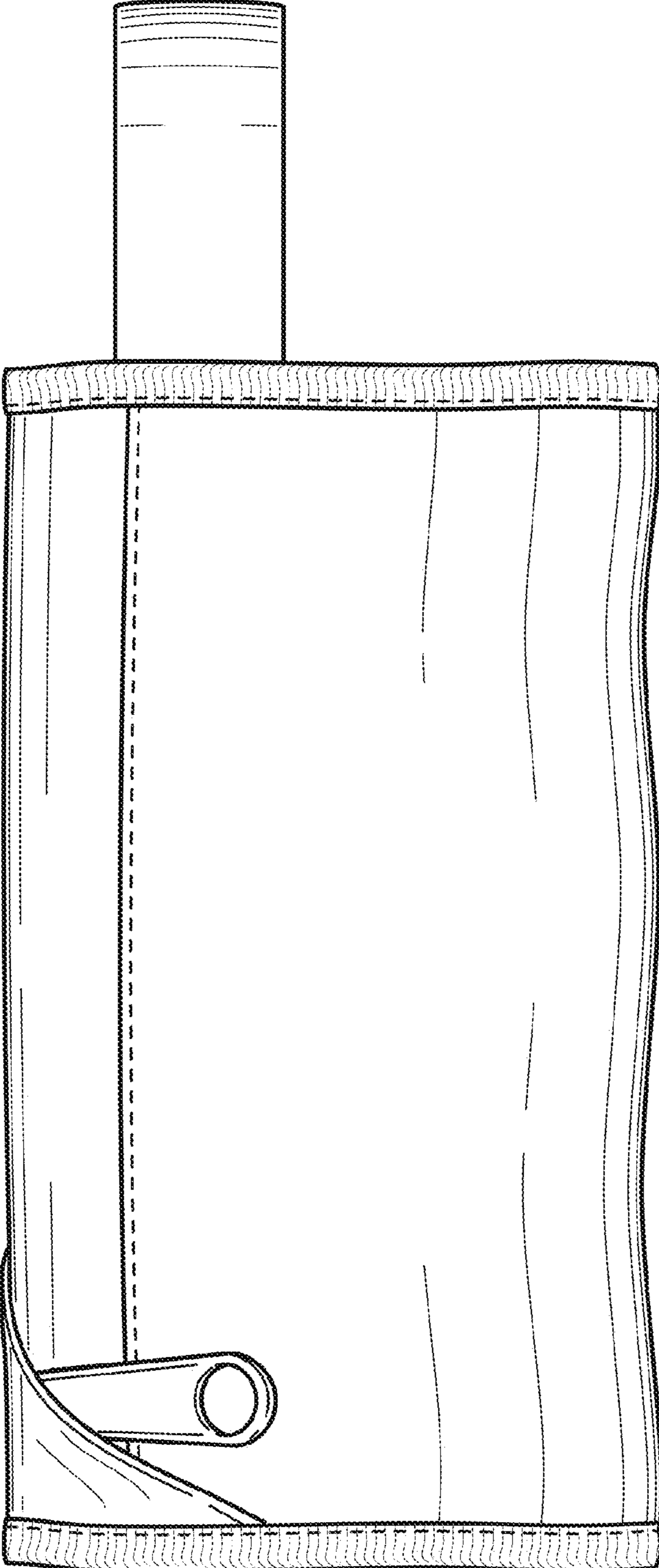

FIG. 2

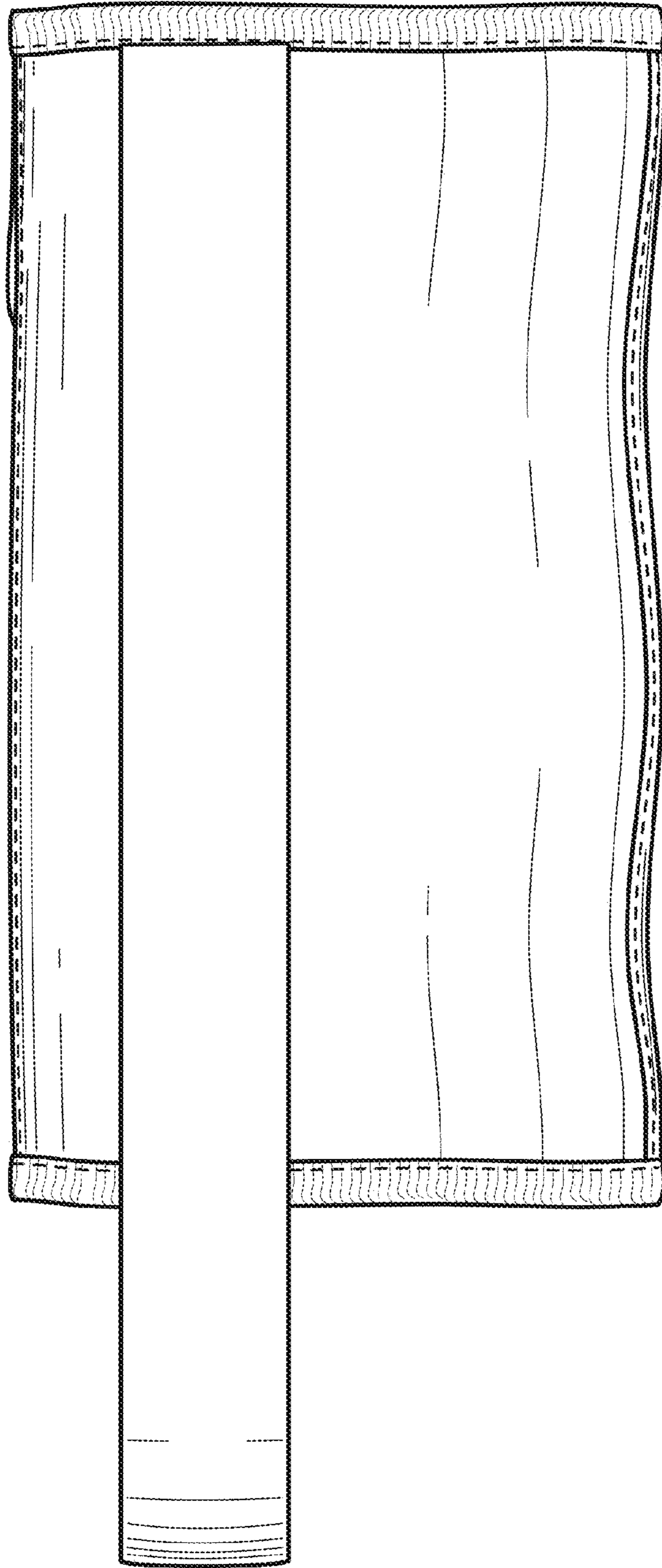

FIG. 3

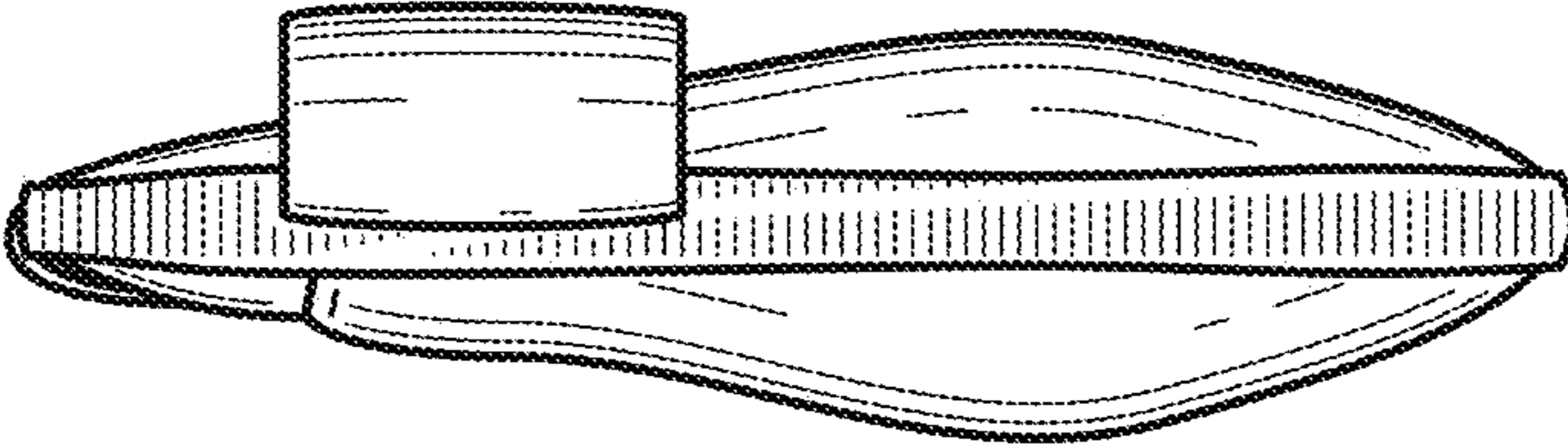

FIG. 5

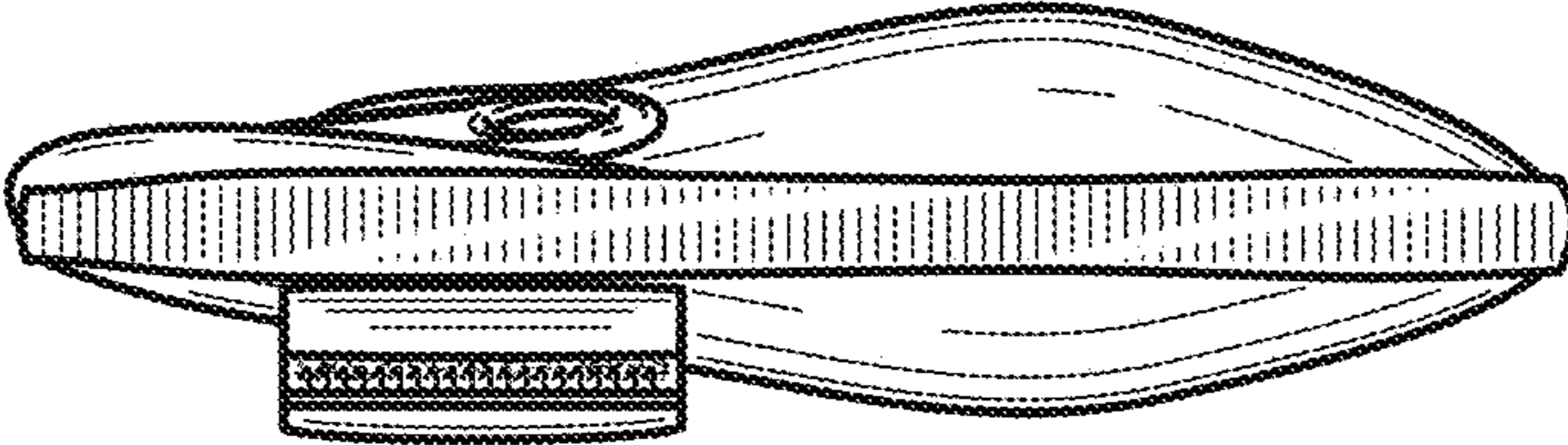

FIG. 4

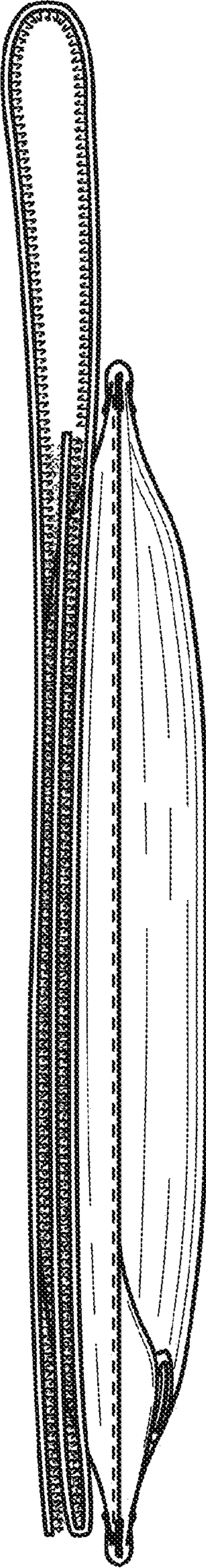

FIG. 6

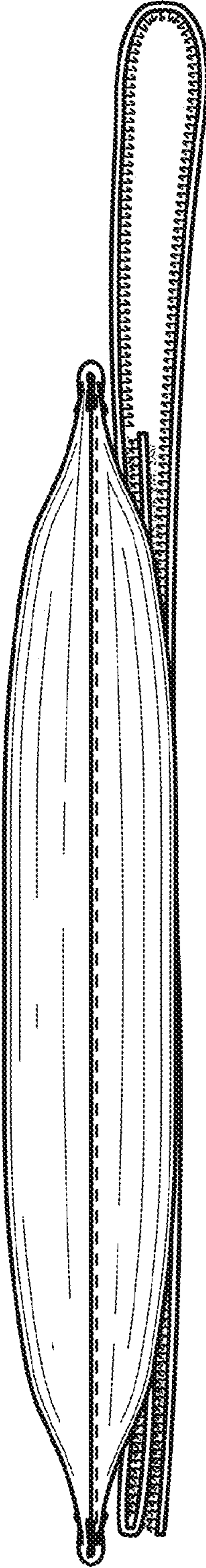
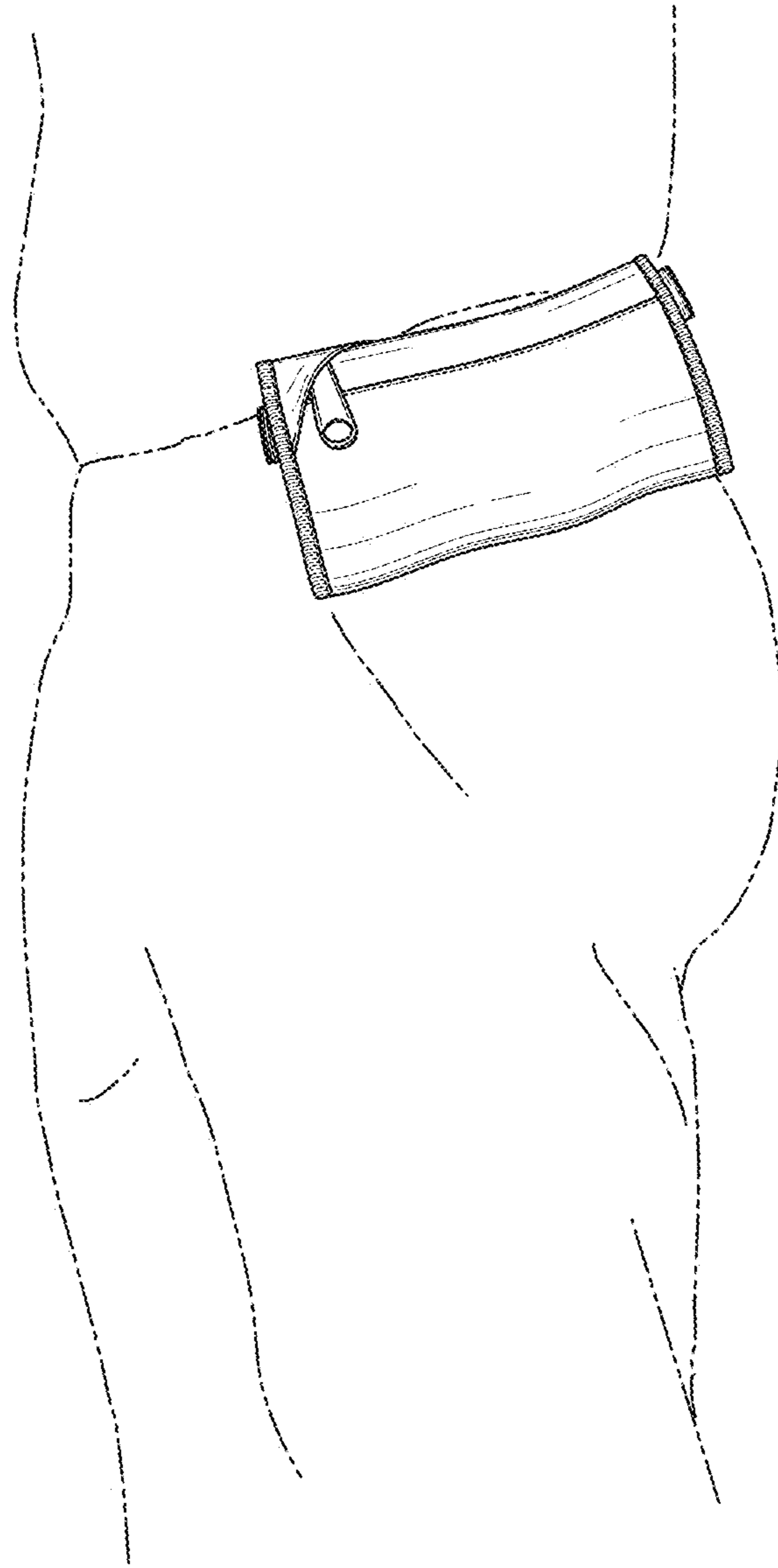

FIG. 7



**FIG. 8**