



US00D719154S

(12) **United States Design Patent**
Lee et al.

(10) **Patent No.:** **US D719,154 S**
(45) **Date of Patent:** **** Dec. 9, 2014**

(54) **HEAD MOUNTED DISPLAY DEVICE**

(71) Applicant: **LG Electronics Inc.**, Seoul (KR)

(72) Inventors: **Hophil Lee**, Seoul (KR); **Eunseok Choi**, Seoul (KR); **Seungbeom Park**, Seoul (KR)

(73) Assignee: **LG Electronics Inc.**, Seoul (KR)

(**) Term: **14 Years**

(21) Appl. No.: **29/499,743**

(22) Filed: **Aug. 19, 2014**

(30) **Foreign Application Priority Data**

Feb. 21, 2014 (KR) 30-2014-0008950

(51) **LOC (10) Cl.** **14-02**

(52) **U.S. Cl.**
USPC **D14/372**

(58) **Field of Classification Search**
CPC G02B 27/017; G02B 27/0158; G02B 27/0161; G02B 27/0181; G02B 27/0185; G02B 27/0189
USPC D14/372, 496, 432, 371, 125, 126, 129, D14/299; D16/300-342; 351/158, 153, 144; 345/7-9, 905; 455/344; 348/115, 53, 348/121, 739

See application file for complete search history.

(56) **References Cited**

U.S. PATENT DOCUMENTS

D533,893 S * 12/2006 Canavan et al. D16/330
D659,739 S * 5/2012 Olsson et al. D16/300
D660,341 S * 5/2012 Olsson et al. D16/300
D662,964 S * 7/2012 Olsson et al. D16/300
D664,184 S * 7/2012 Olsson et al. D16/309
D664,586 S * 7/2012 Olsson D16/300

D665,008 S * 8/2012 Olsson et al. D16/309
D671,589 S * 11/2012 Olsson D16/300
D688,727 S * 8/2013 Olsson D16/300
D697,962 S * 1/2014 Olsson D16/300
D703,724 S * 4/2014 Olsson D16/300
D708,181 S * 7/2014 Olsson et al. D14/372
D711,373 S * 8/2014 Lee et al. D14/372
D713,406 S * 9/2014 Pombo et al. D14/372
2004/0113867 A1 * 6/2004 Tomine et al. 345/8
2005/0270477 A1 * 12/2005 Curci et al. 351/109

* cited by examiner

Primary Examiner — Austin Murphy

(74) *Attorney, Agent, or Firm* — Morgan, Lewis & Bockius LLP

(57) **CLAIM**

The ornamental design for a head mounted display device, as shown and described.

DESCRIPTION

FIG. 1 is a perspective view of a head mounted display device showing our new design;
FIG. 2 is a front view thereof;
FIG. 3 is a rear view thereof;
FIG. 4 is a left side view thereof;
FIG. 5 is a right side view thereof;
FIG. 6 is a top plan view thereof;
FIG. 7 is a bottom plan view thereof;
FIG. 8 is a perspective view thereof, showing the display detached from the neckband;
FIG. 9 is a side view thereof, showing the article in a position of use;
FIG. 10 is a side view thereof, showing the article in a position of use but with the display detached from the neckband; and, FIG. 11 is a front view thereof; but with a portion of the article shown as transparent.

The broken lines show unclaimed subject matter only and form no part of the claimed design.

1 Claim, 11 Drawing Sheets

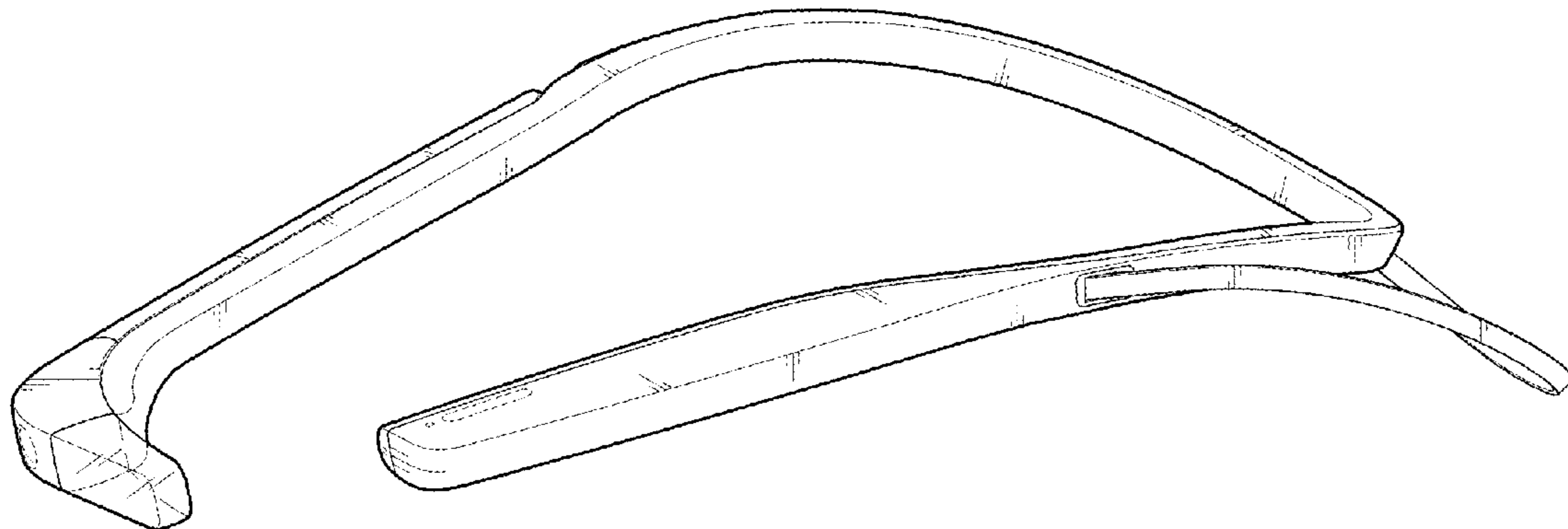

FIG. 1

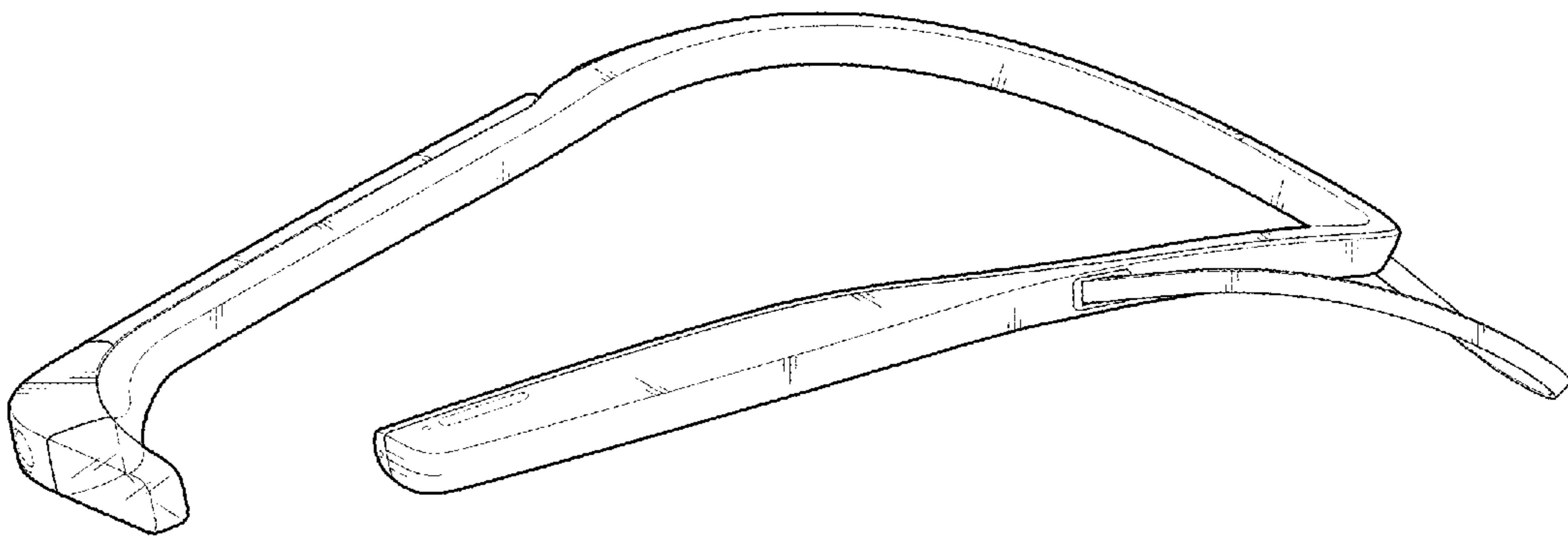

FIG. 2

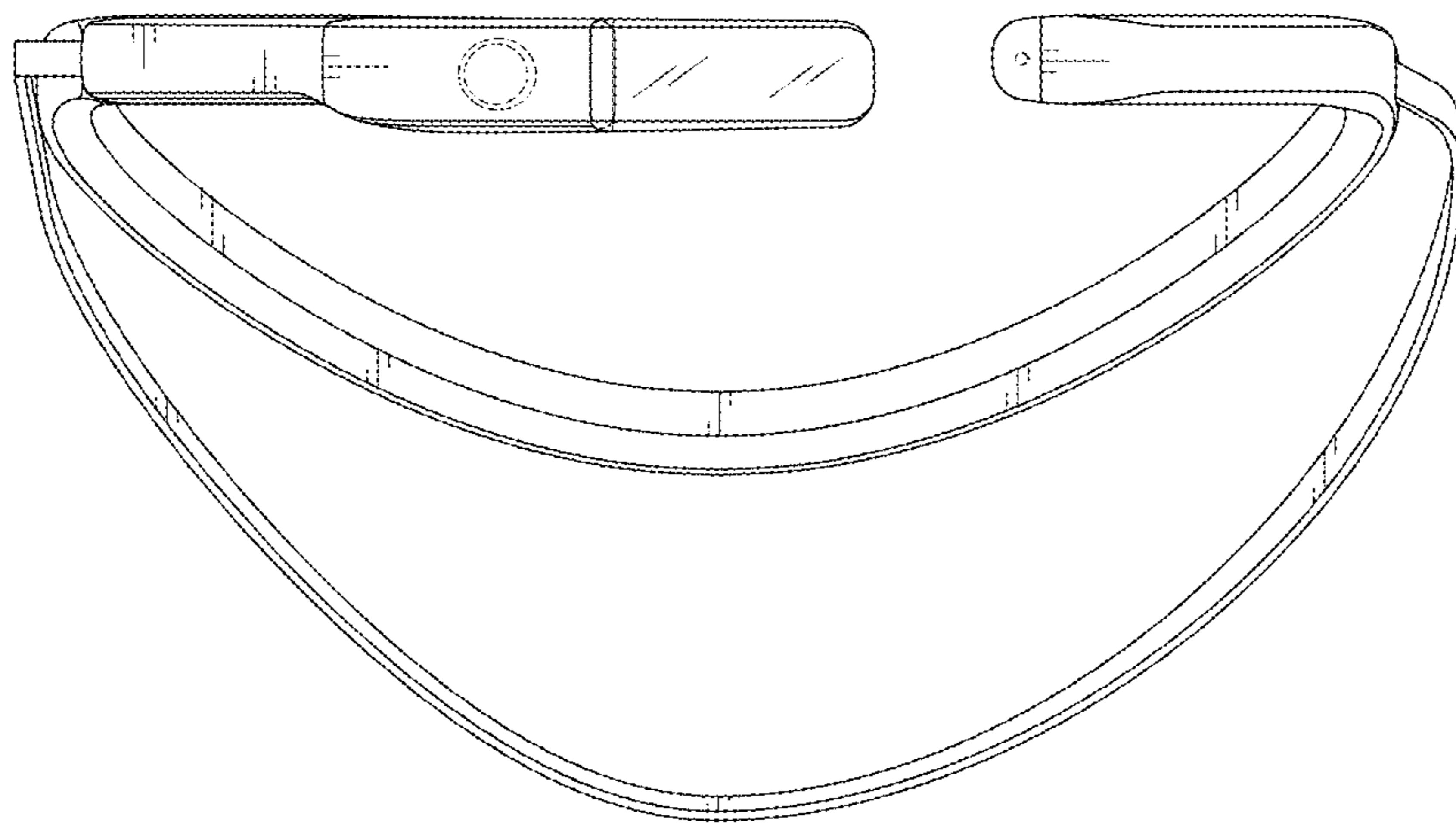

FIG. 3

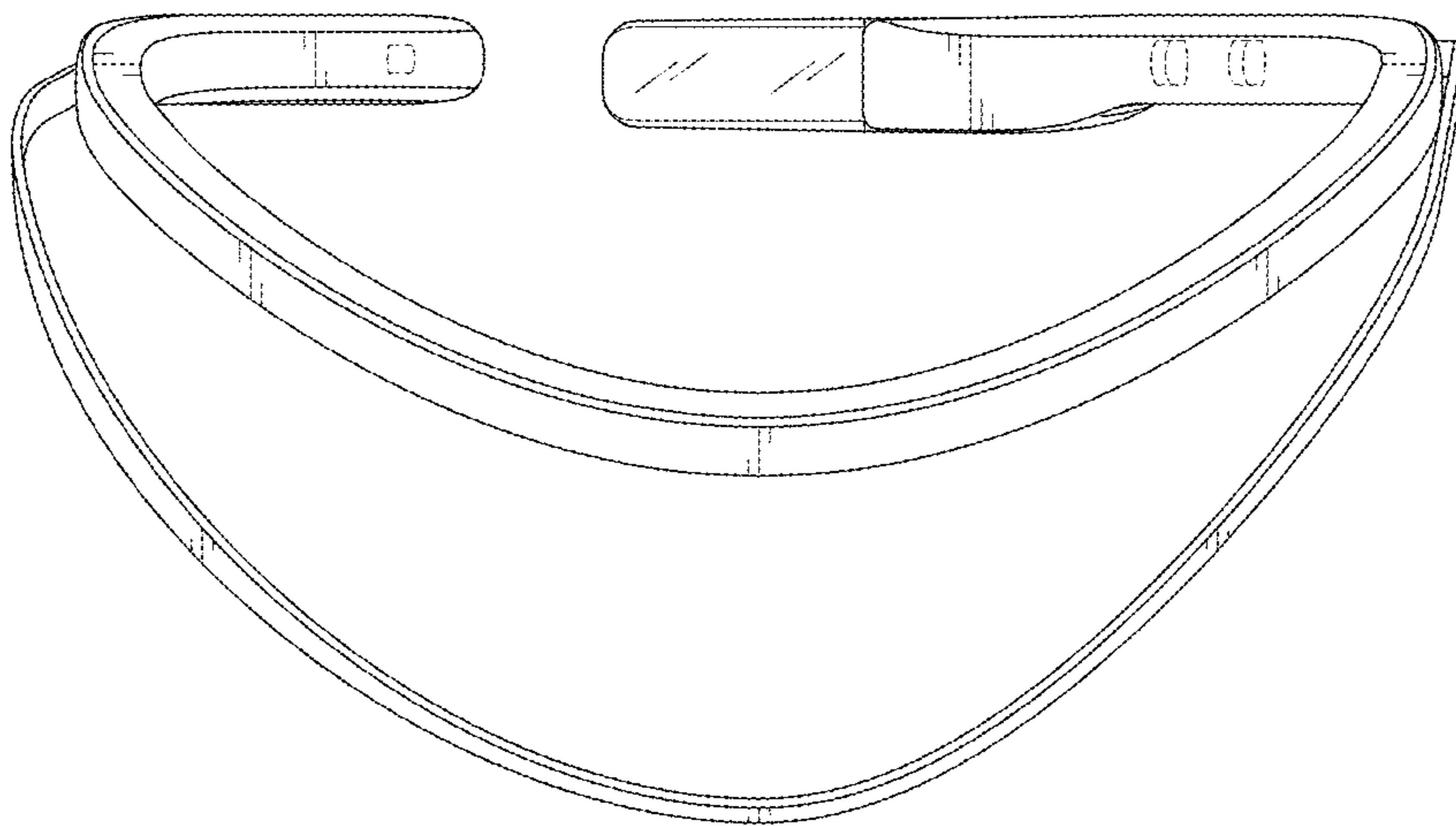

FIG. 4

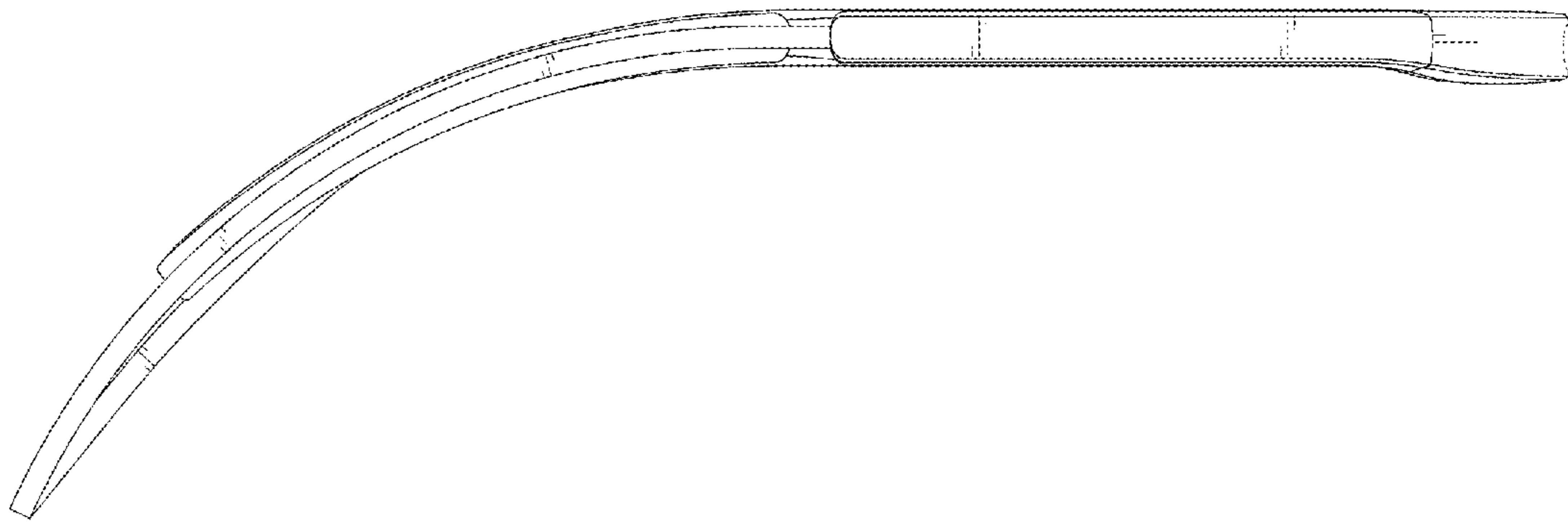

FIG. 5

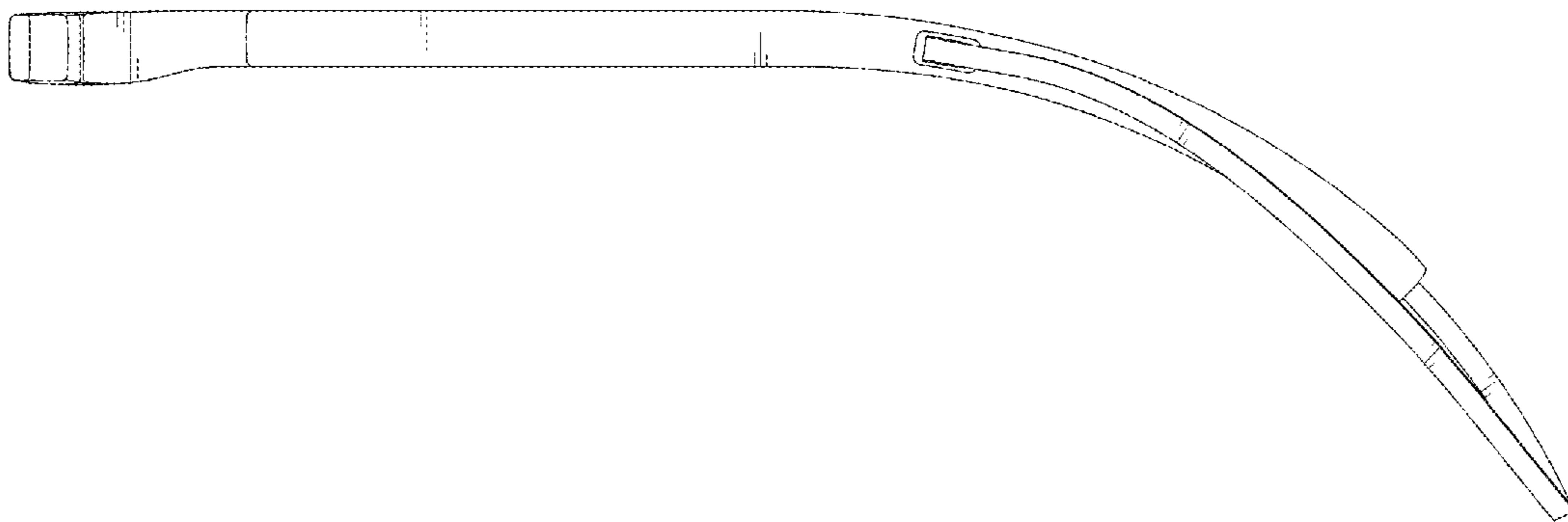

FIG. 6

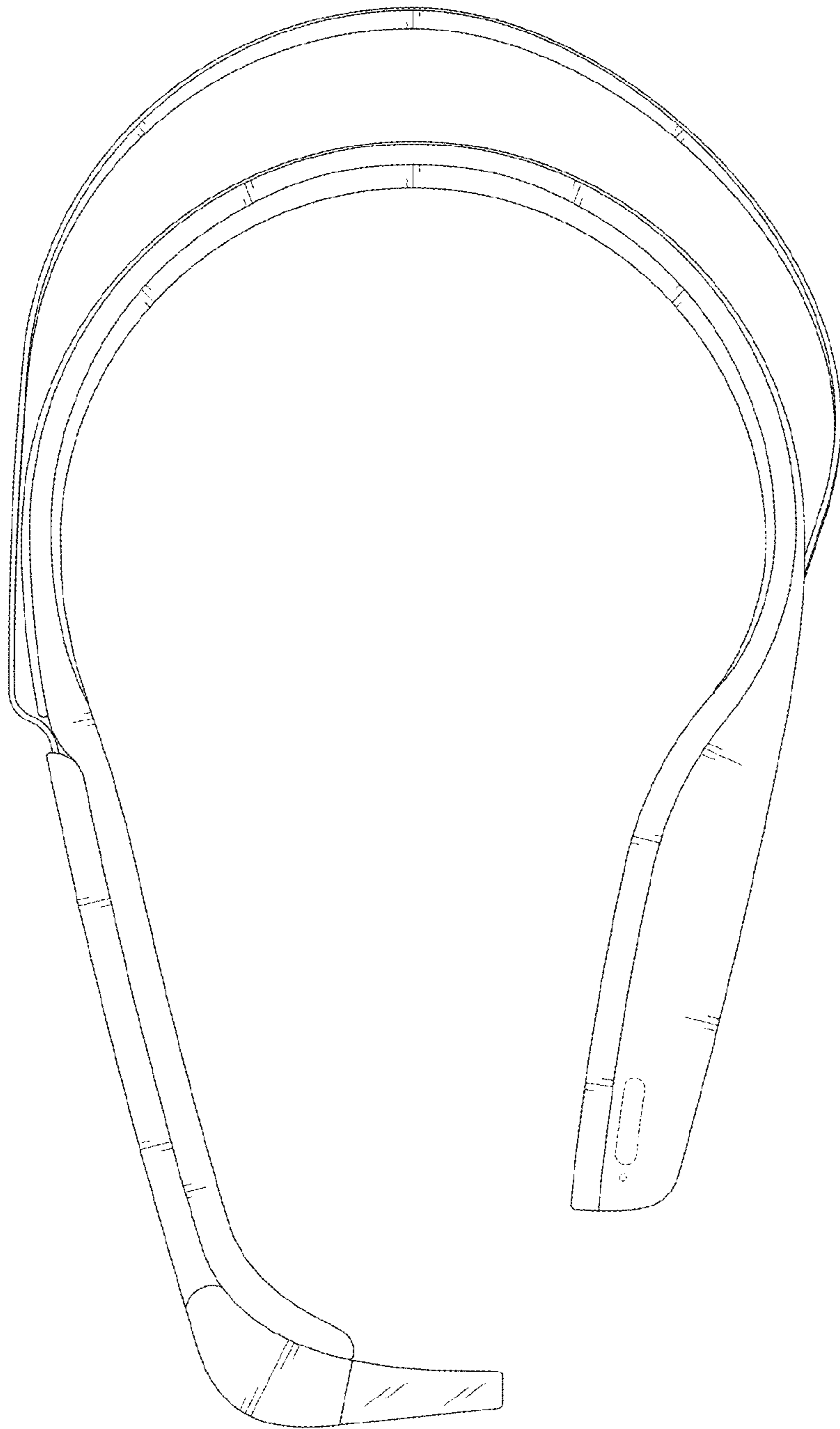

FIG. 7

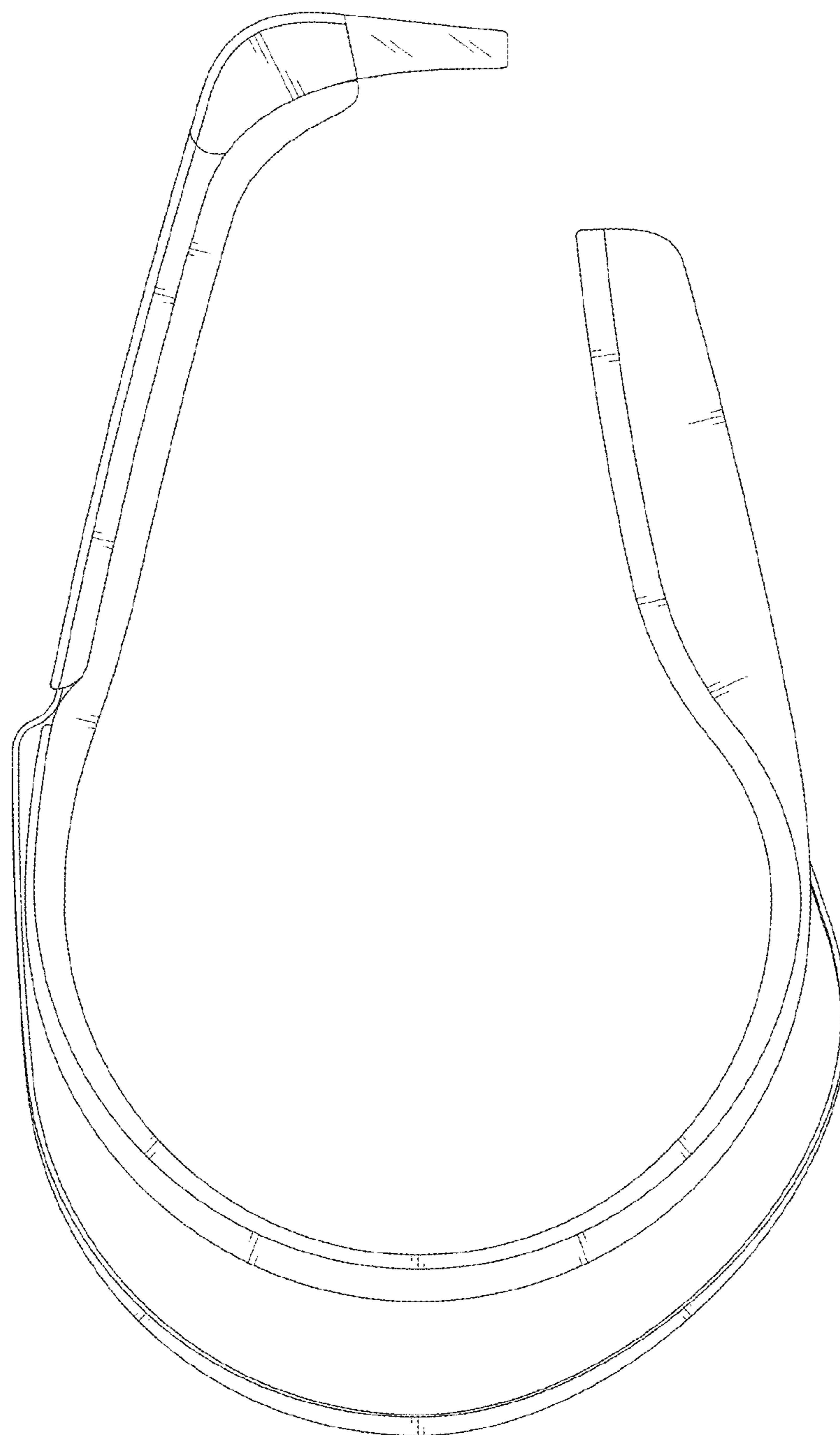

FIG. 8

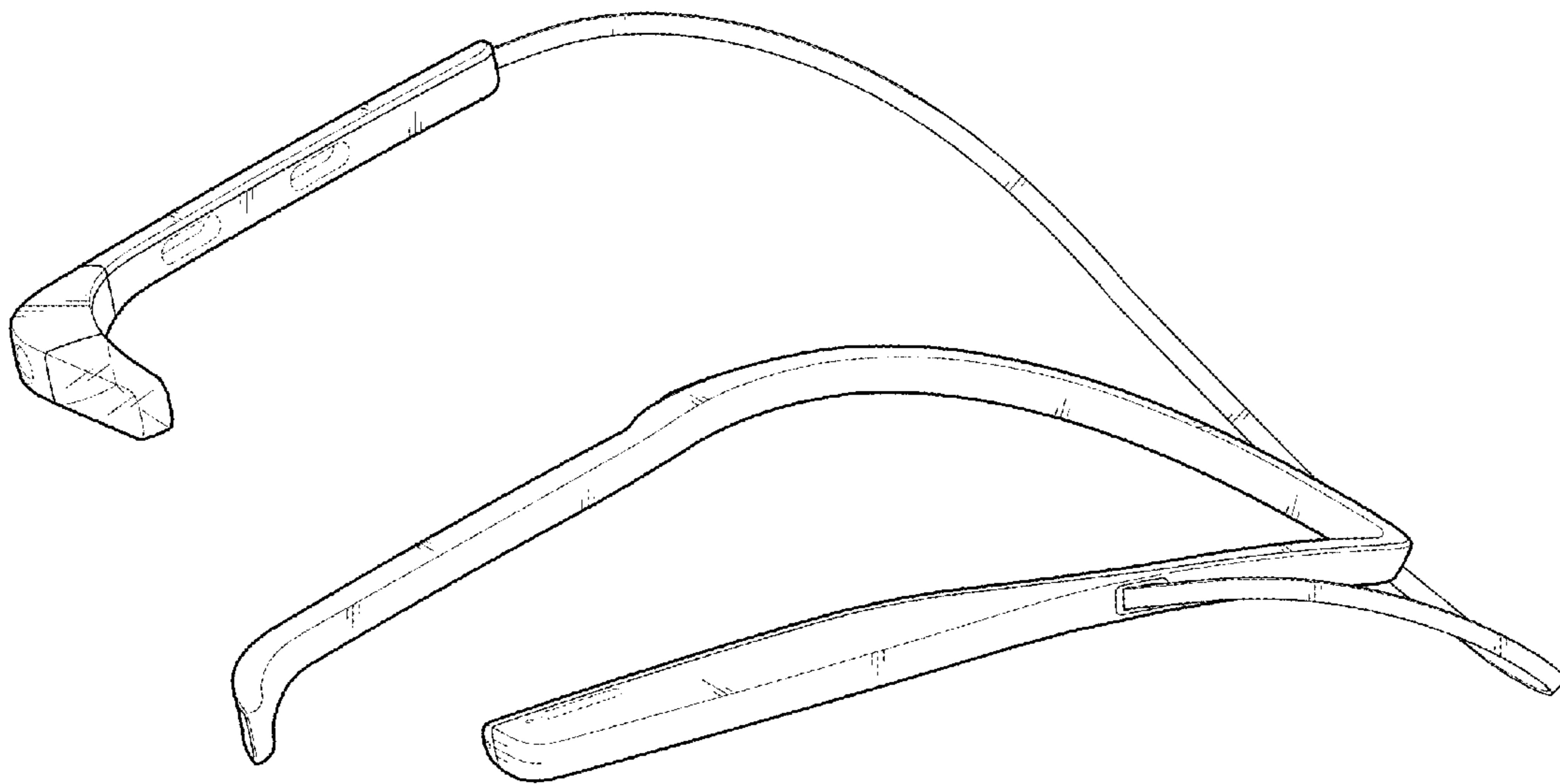

FIG. 9

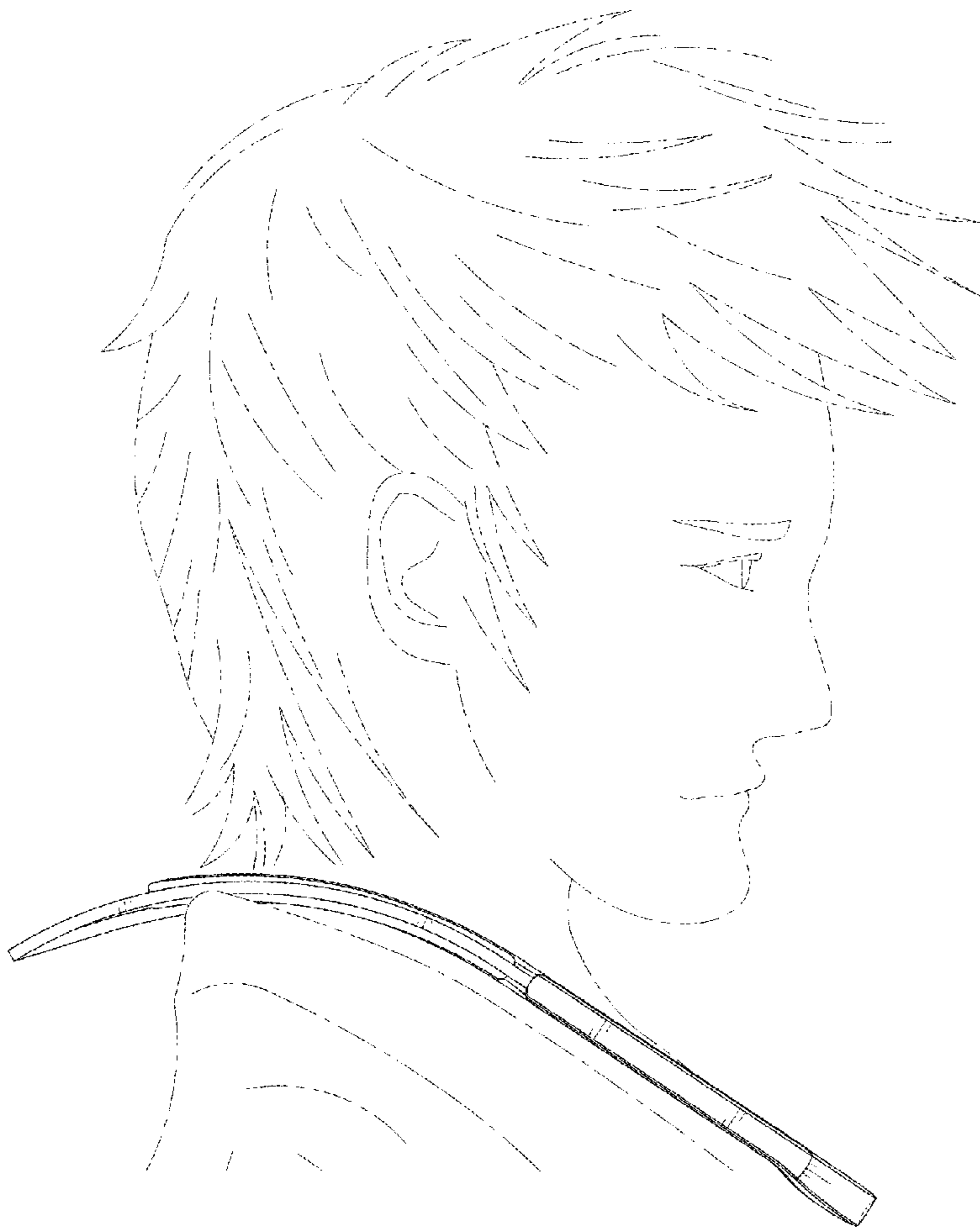

FIG. 10

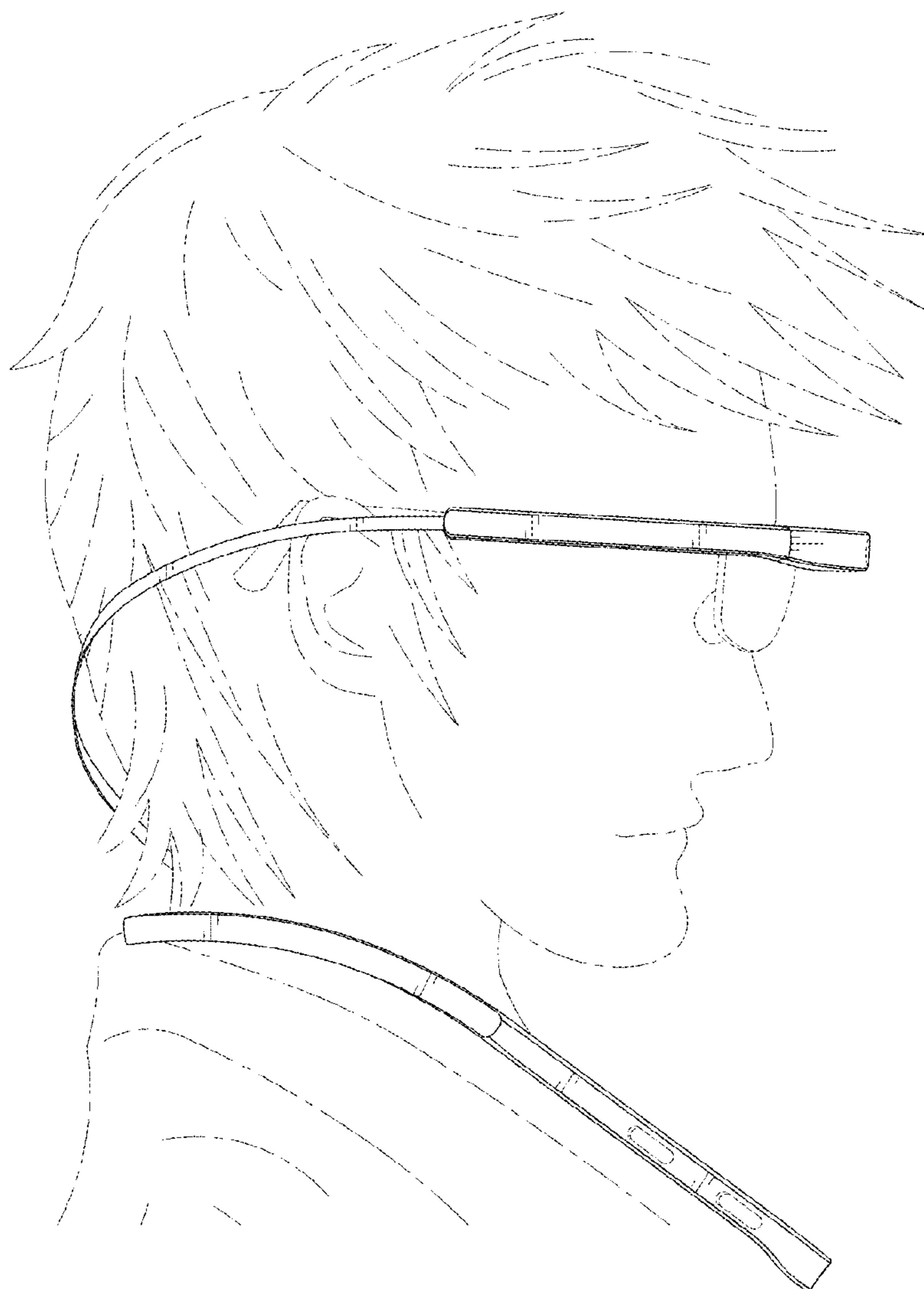

FIG. 11

