



US00D719142S

(12) **United States Design Patent**
Lee et al.

(10) **Patent No.:** **US D719,142 S**
(45) **Date of Patent:** **** Dec. 9, 2014**

(54) **STAND FOR TELEVISION RECEIVER**

(71) Applicant: **Samsung Electronics Co., Ltd.**,
Suwon-si (KR)

(72) Inventors: **Giljae Lee**, Seoul (KR); **Jaehyung Kim**,
Gwangju Si (KR); **BoKyung Seong**,
Daejeon (KR)

(73) Assignee: **Samsung Electronics Co., Ltd.**,
Suwon-si (KR)

(**) Term: **14 Years**

(21) Appl. No.: **29/483,013**

(22) Filed: **Feb. 25, 2014**

(30) **Foreign Application Priority Data**

Sep. 4, 2013 (KR) 30-2013-0045673

(51) **LOC (10) Cl.** **14-03**

(52) **U.S. Cl.**
USPC **D14/239**

(58) **Field of Classification Search**
CPC H04N 5/64; H04N 5/645; H04N 5/655
USPC D14/125-129, 239, 371-375, 336, 337;
341/12; 345/104, 156, 168, 173;
348/180, 184, 325, 739; 349/1, 2, 11,
349/62; 361/679.05-679.07, 679.21;
D6/300, 308

See application file for complete search history.

(56) **References Cited**

U.S. PATENT DOCUMENTS

7,965,498 B2 * 6/2011 Gotham et al. 361/679.21
D649,153 S * 11/2011 Symons D14/447

8,047,488 B2 * 11/2011 Wang et al. 248/291.1
D652,043 S * 1/2012 Lee D14/447
D655,266 S * 3/2012 Kim D14/126
8,289,344 B2 * 10/2012 Marcu et al. 345/590
D679,268 S * 4/2013 Won et al. D14/239
D680,106 S * 4/2013 Hwangbo et al. D14/239
D682,285 S * 5/2013 Skinner et al. D14/451
D687,036 S * 7/2013 Seong et al. D14/374
D691,606 S * 10/2013 Andre et al. D14/374
D691,998 S * 10/2013 Seo et al. D14/374
D698,325 S * 1/2014 Kim et al. D14/126

* cited by examiner

Primary Examiner — Randall Gholson

(74) *Attorney, Agent, or Firm* — NSIP Law

(57) **CLAIM**

We claim the ornamental design for a stand for television receiver, as shown and described.

DESCRIPTION

FIG. 1 is a front perspective view of a stand for television receiver showing our new design;
FIG. 2 is a front view thereof;
FIG. 3 is a rear view thereof;
FIG. 4 is a left-side view thereof;
FIG. 5 is a right-side view thereof;
FIG. 6 is a top view thereof;
FIG. 7 is a bottom view thereof;
FIG. 8 is a rear perspective view thereof; and,
FIG. 9 is another front perspective view, in which a television receiver in broken lines is provided to illustrate an example environment.

The broken lines shown in the drawings show unclaimed subject matter only and form no part of the claimed design.

1 Claim, 9 Drawing Sheets

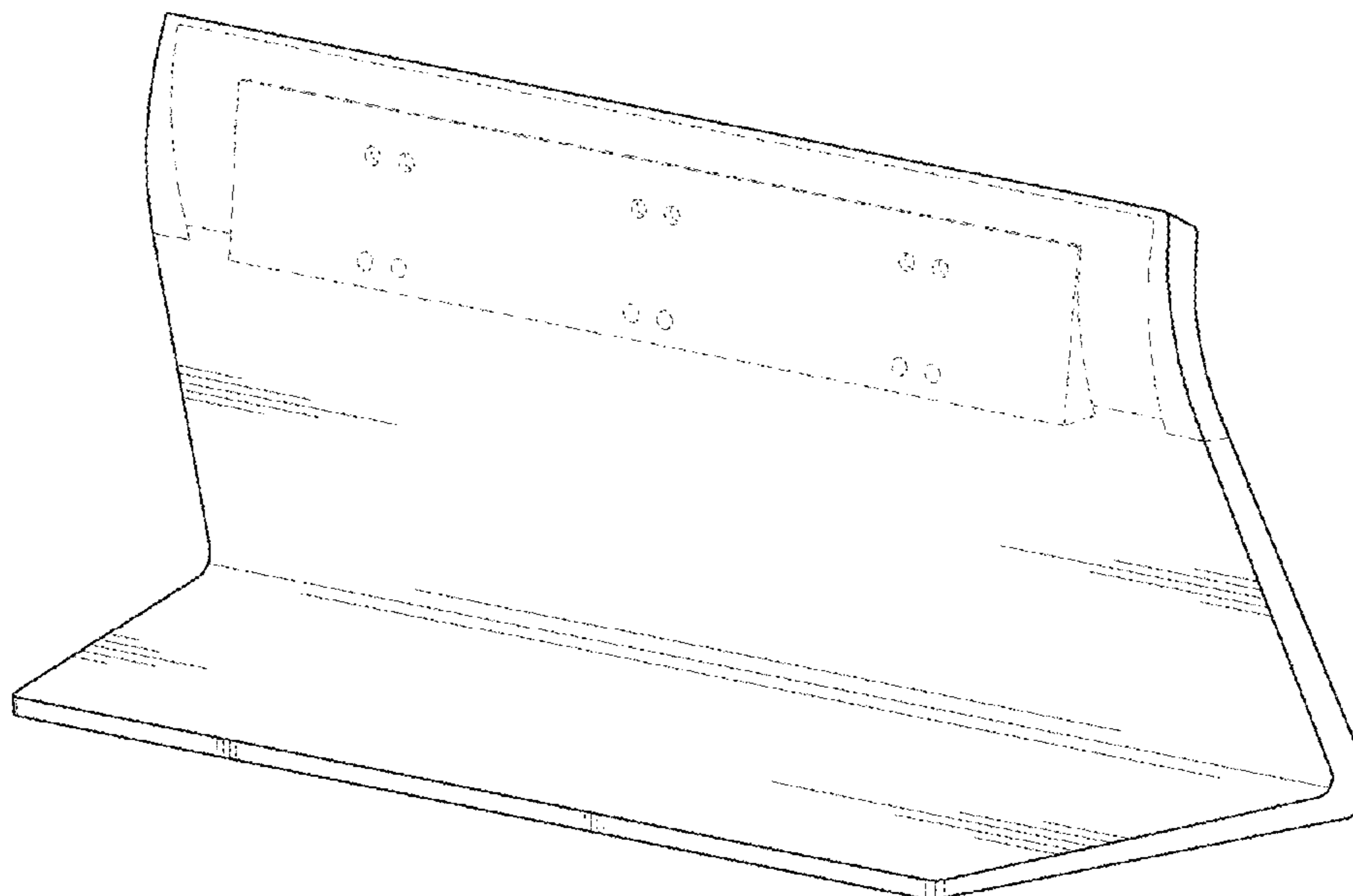

FIG. 1

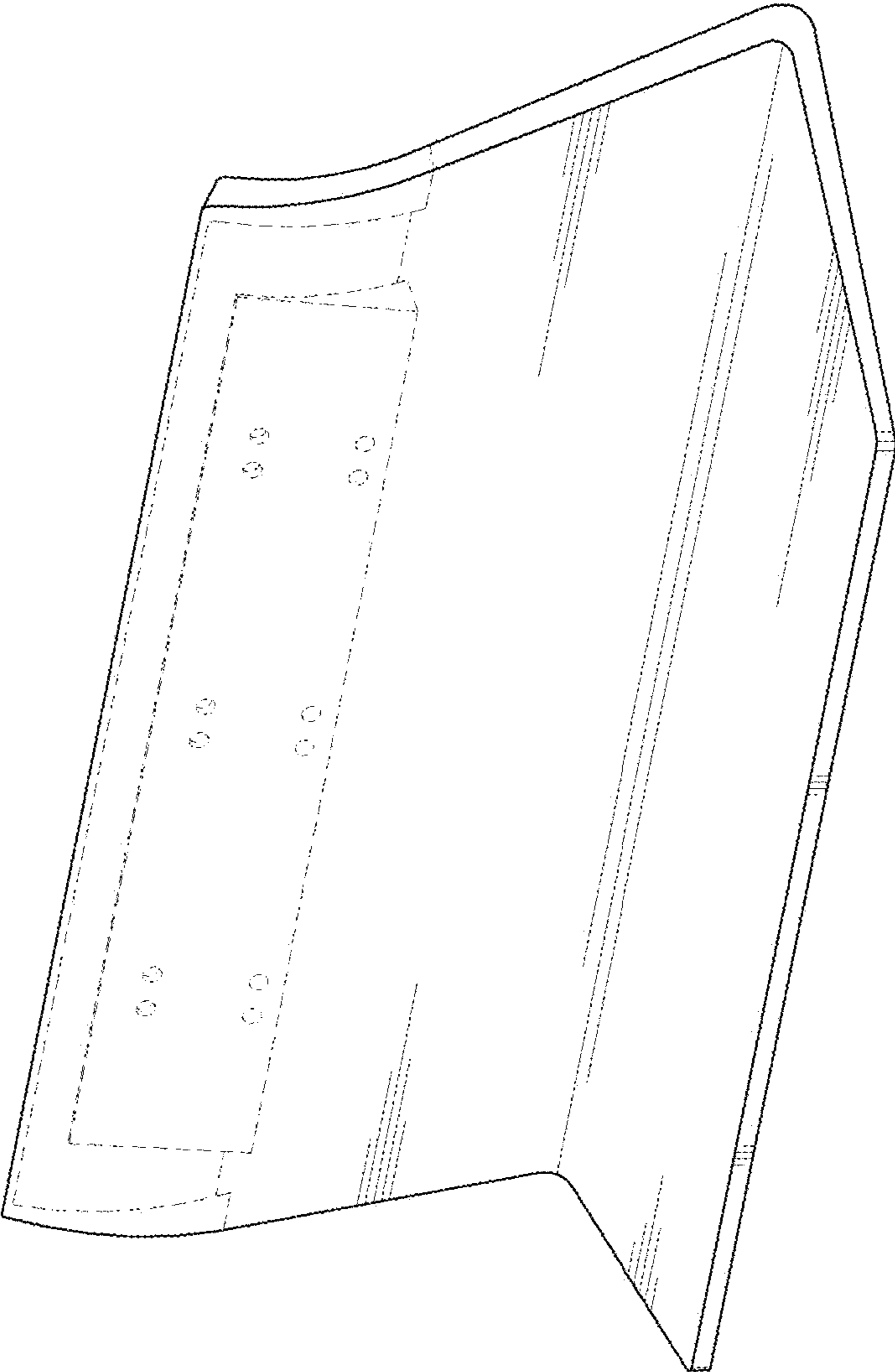

FIG. 2

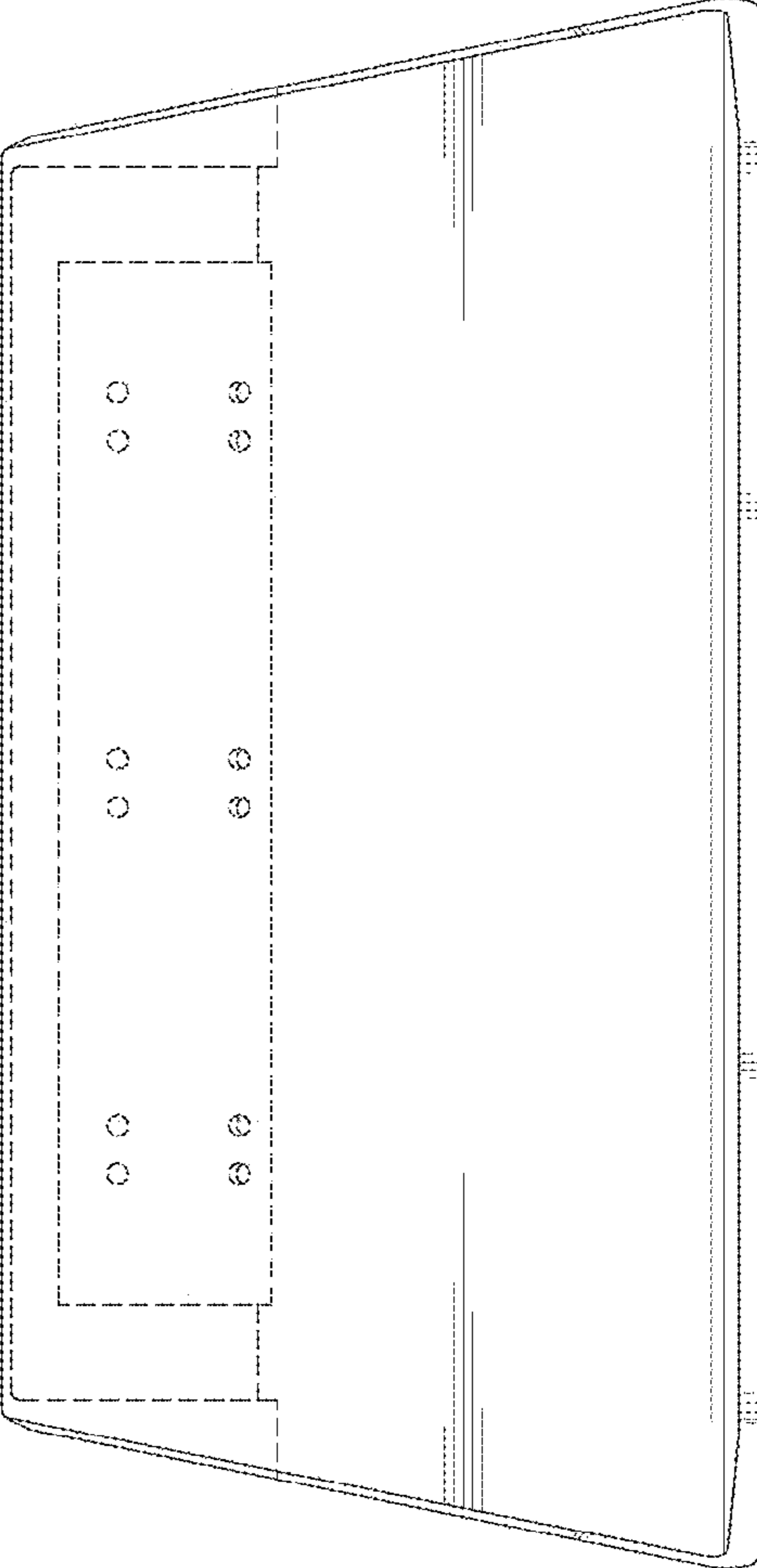

FIG. 3

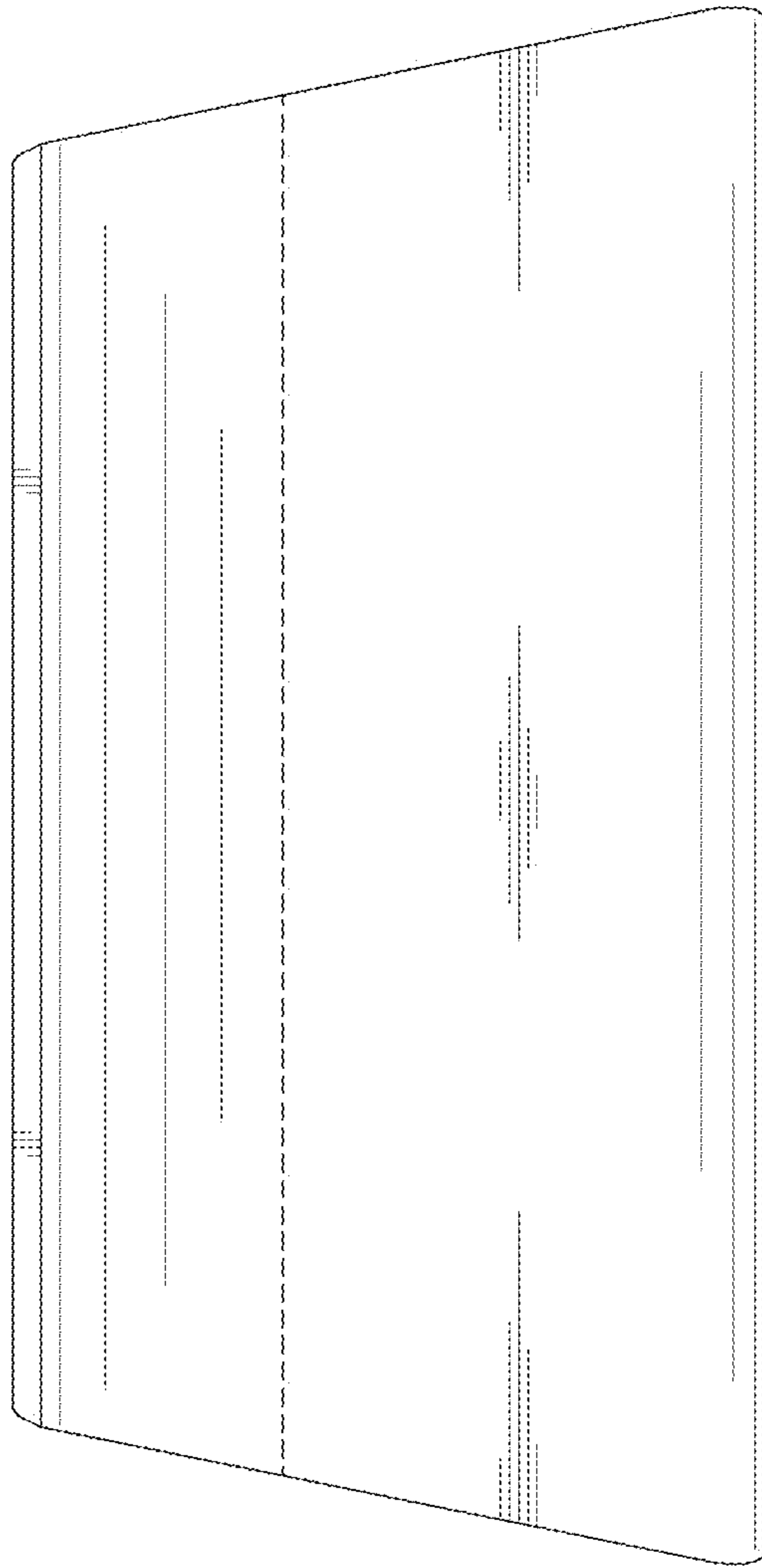

FIG. 4

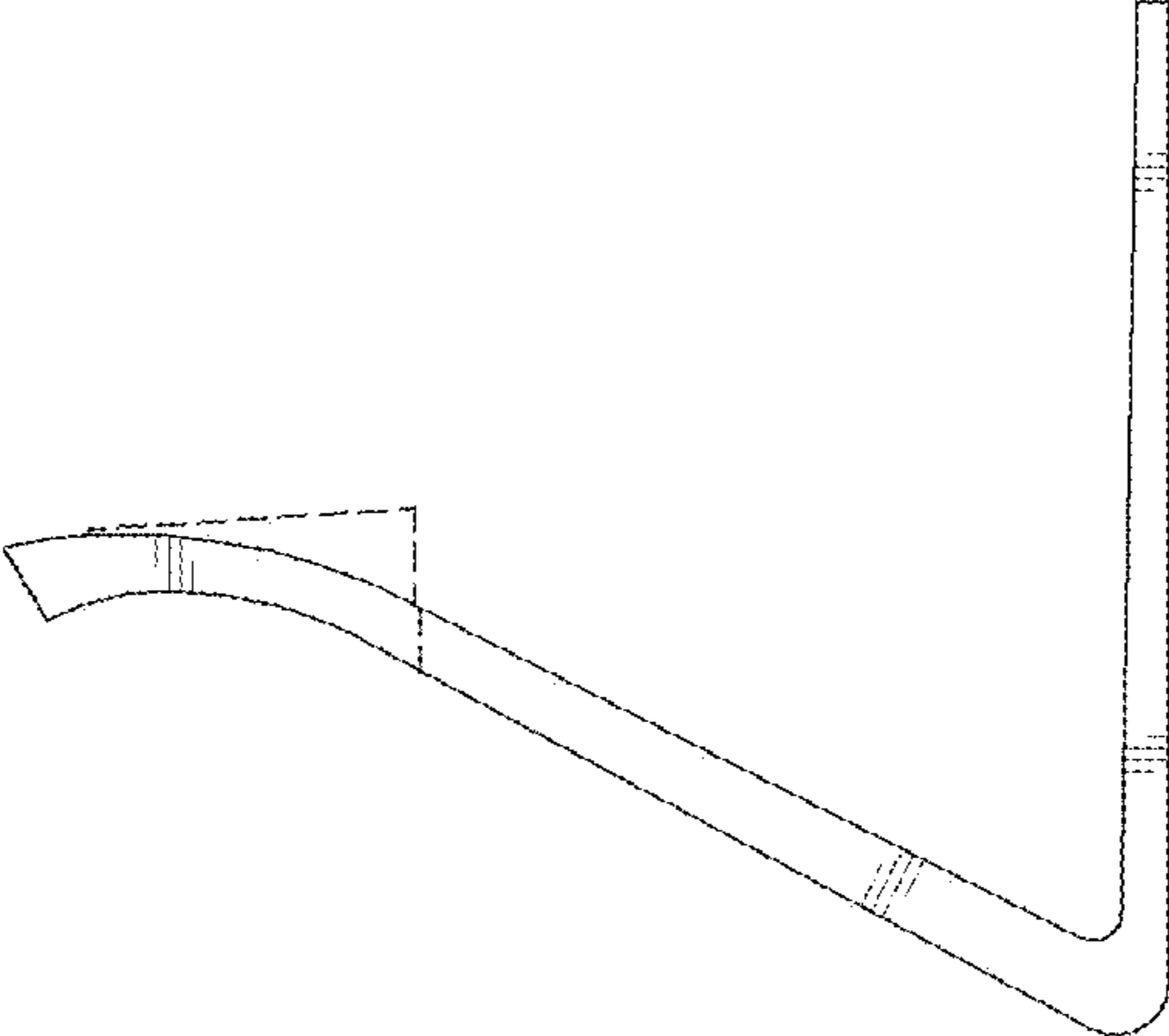

FIG. 5

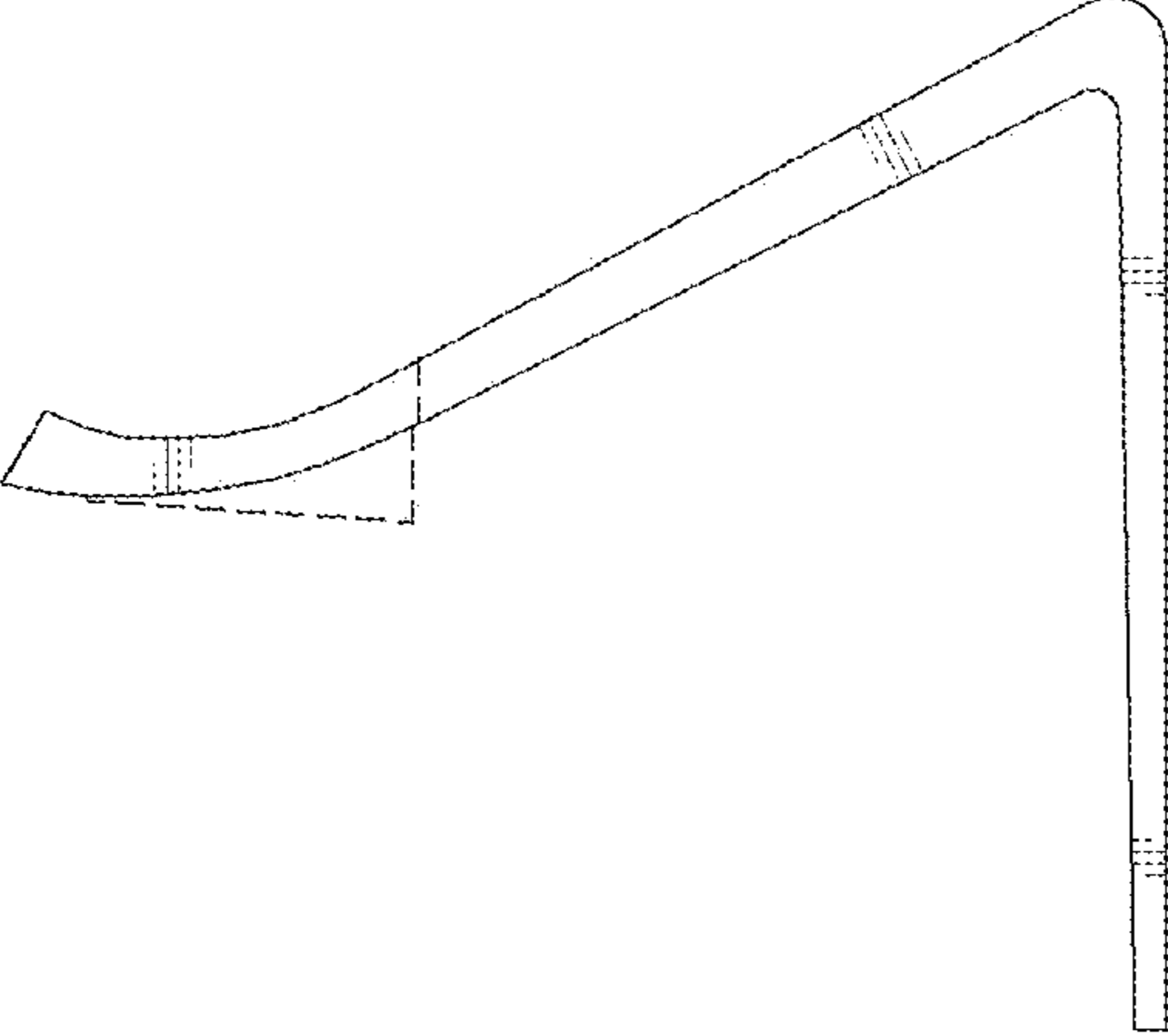

FIG. 6

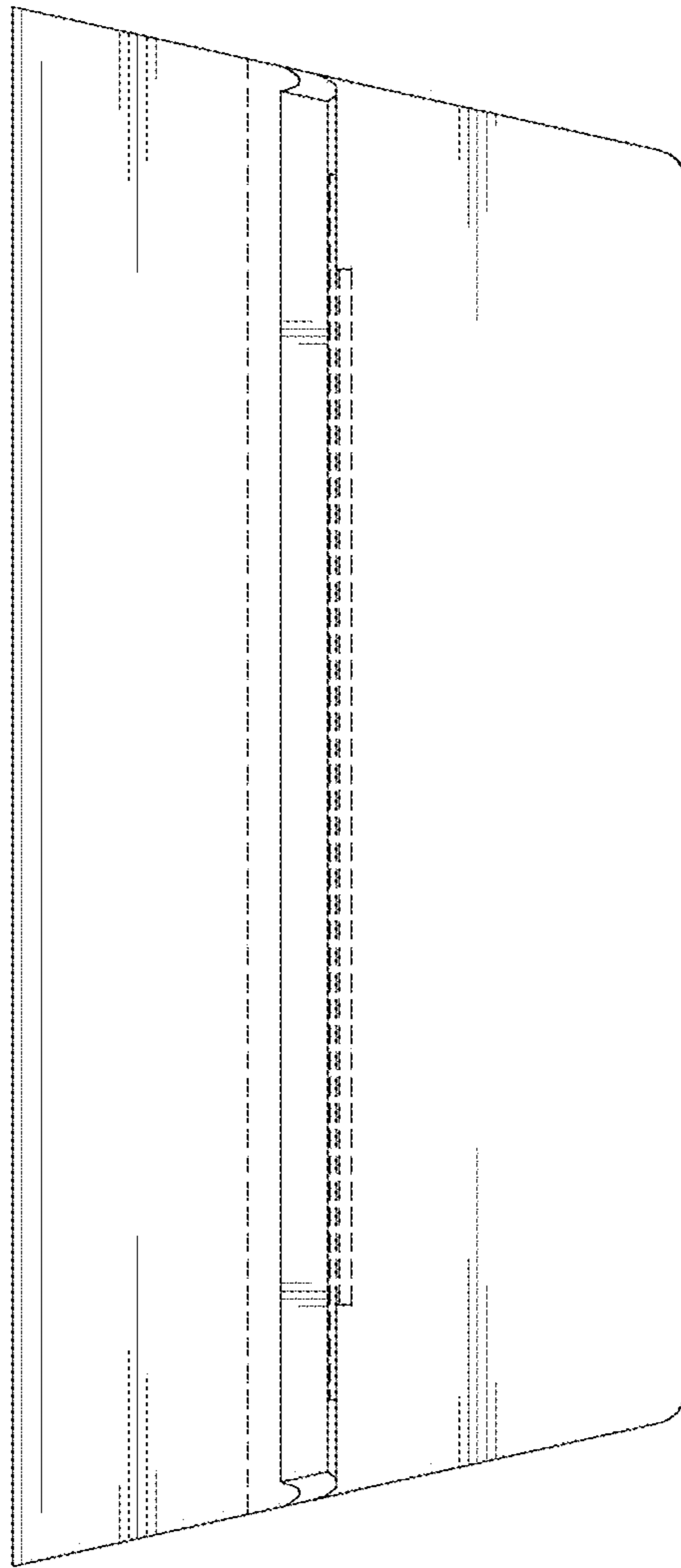

FIG. 7

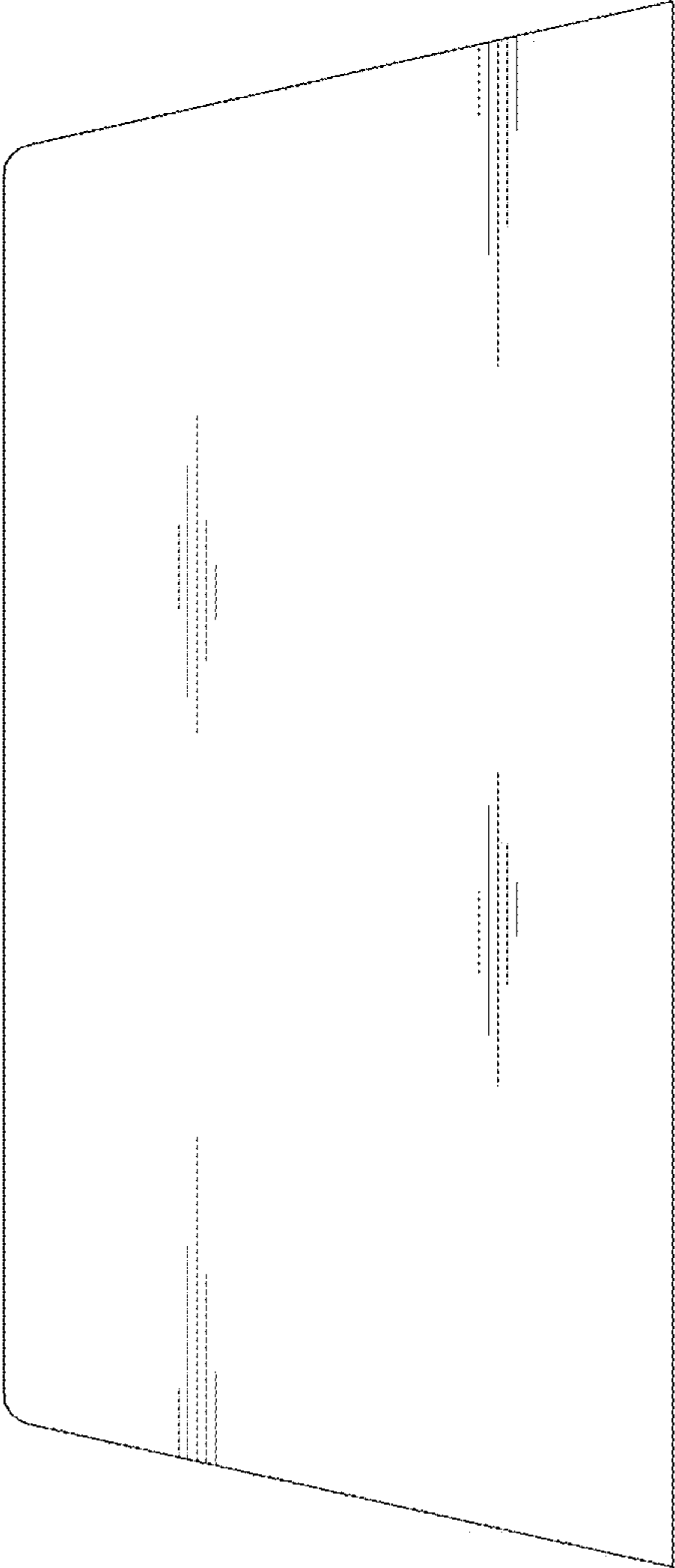

FIG. 8

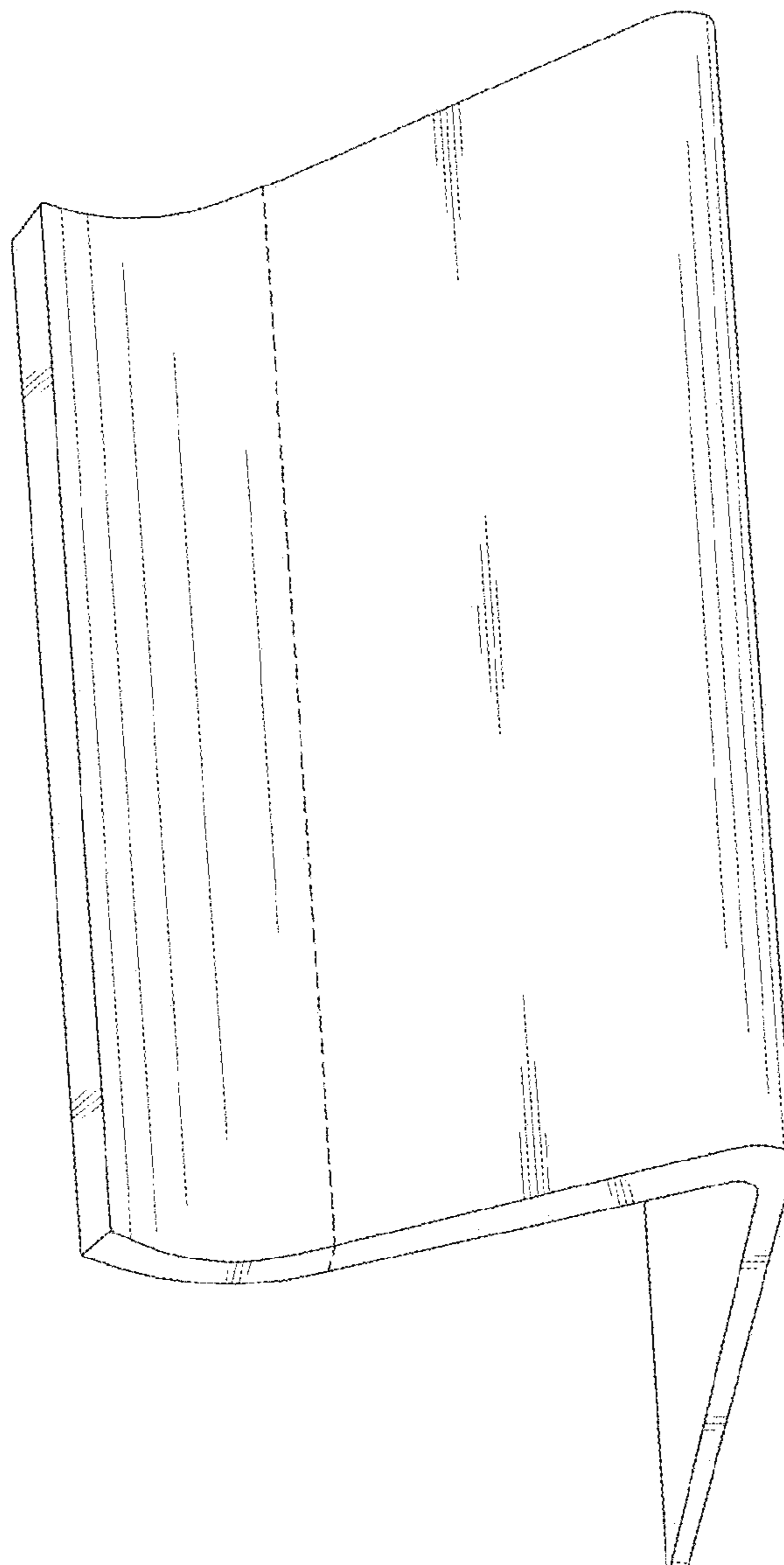

FIG. 9

