



US00D719114S

(12) **United States Design Patent**
Yamazaki et al.

(10) **Patent No.:** **US D719,114 S**

(45) **Date of Patent:** **** Dec. 9, 2014**

(54) **REACTION TUBE**

D405,431 S * 2/1999 Shimazu D13/182
D406,113 S * 2/1999 Hanagata et al. D13/182
D407,696 S * 4/1999 Shimazu D13/182

(71) Applicant: **Hitachi Kokusai Electric Inc.**, Tokyo
(JP)

(Continued)

(72) Inventors: **Keishin Yamazaki**, Toyama (JP);
Masahiro Miyake, Toyama (JP);
Kosuke Takagi, Toyama (JP); **Yasuaki**
Komae, Toyama (JP); **Shinya Morita**,
Toyama (JP); **Naonori Akae**, Toyama
(JP); **Masato Terasaki**, Toyama (JP)

FOREIGN PATENT DOCUMENTS

JP 1359196 S 5/2009
JP 1359505 S 5/2009

(Continued)

(73) Assignee: **Hitachi Kokusai Electric Inc.**, Tokyo
(JP)

Primary Examiner — Elizabeth J Oswecki

(74) *Attorney, Agent, or Firm* — Antonelli, Terry, Stout &
Kraus, LLP.

(**) Term: **14 Years**

(57) **CLAIM**

We claim the ornamental design for a reaction tube, as shown
and described.

(21) Appl. No.: **29/477,773**

DESCRIPTION

(22) Filed: **Dec. 26, 2013**

(30) **Foreign Application Priority Data**

Jun. 28, 2013 (JP) 2013-014833

(51) **LOC (10) Cl.** **13-03**

(52) **U.S. Cl.**
USPC **D13/182**

(58) **Field of Classification Search**
USPC D13/182; 118/50, 722, 724, 733, 715,
118/725; 219/385, 390, 391, 411, 496, 486,
219/523; 432/239, 241, 247, 251, 253, 266;
110/185; 373/109, 110, 111
See application file for complete search history.

FIG. 1 is a front, top and right side perspective view of a
reaction tube showing our new design;
FIG. 2 is a front elevational view thereof;
FIG. 3 is a rear elevational view thereof;
FIG. 4 is a left side elevational view thereof;
FIG. 5 is a right side elevational view thereof;
FIG. 6 is a top plan view thereof;
FIG. 7 is a bottom plan view thereof;
FIG. 8 is an enlarged top plan view thereof;
FIG. 9 is an enlarged bottom plan view thereof;
FIG. 10 is a cross-sectional view taken along line 10-10 in
FIG. 2 thereof;
FIG. 11 is an enlarged cross-sectional view taken along line
11-11 in FIG. 10 thereof;
FIG. 12 is a cross-sectional view taken along line 12-12 in
FIG. 6 thereof; and,
FIG. 13 is a cross-sectional view taken along line 13-13 in
FIG. 6 thereof.

The dashed-dot-dashed lines represent the boundary lines of
the claimed design. The broken lines shown in the drawings
represent portions of the reaction tube that form no part of the
claimed design.

(56) **References Cited**

U.S. PATENT DOCUMENTS

D404,368 S * 1/1999 Shimazu D13/182
D405,062 S * 2/1999 Shimazu D13/182
D405,429 S * 2/1999 Hanagata et al. D13/182
D405,430 S * 2/1999 Matsushima D13/182

1 Claim, 8 Drawing Sheets

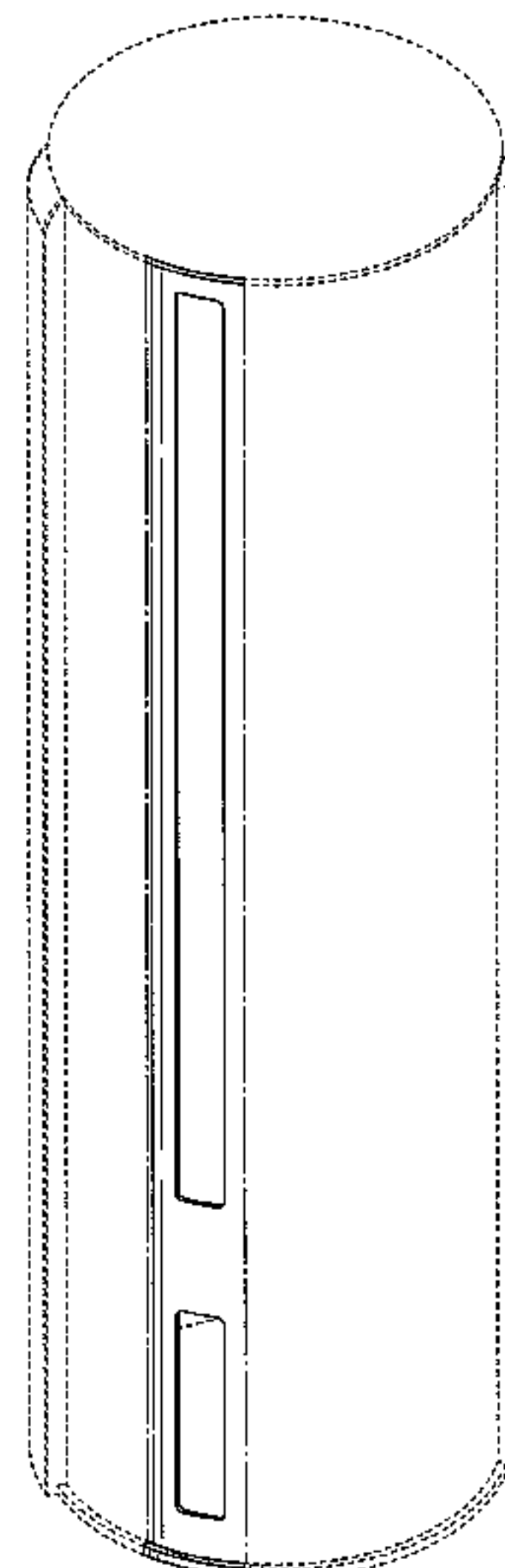

(56)

References Cited

U.S. PATENT DOCUMENTS

D417,438 S * 12/1999 Matsushima D13/182
 D423,463 S * 4/2000 Hanagata et al. D13/182
 D424,024 S * 5/2000 Hanagata et al. D13/182
 D520,467 S * 5/2006 Ishii et al. D13/182
 D586,768 S * 2/2009 Inoue et al. D13/182
 D594,488 S * 6/2009 Toiya et al. D15/144.1
 D600,659 S * 9/2009 Matsuura et al. D13/182
 D610,559 S 2/2010 Okada et al.
 D611,013 S * 3/2010 Takahashi D13/182
 D618,638 S * 6/2010 Nakashima D13/182
 D655,255 S * 3/2012 Takebayashi et al. D13/182
 D655,258 S * 3/2012 Honma et al. D13/182
 D655,262 S * 3/2012 Honma et al. D13/182
 D655,682 S * 3/2012 Takebayashi et al. D13/182

D661,265 S * 6/2012 Kajiya et al. D13/182
 2008/0090195 A1* 4/2008 Takahashi et al. 432/250
 2009/0194521 A1* 8/2009 Kobayashi et al. 219/520
 2009/0250005 A1* 10/2009 Kaneko et al. 118/724

FOREIGN PATENT DOCUMENTS

JP	1359506 S	5/2009
JP	1359507 S	5/2009
JP	1359508 S	5/2009
JP	1359509 S	5/2009
JP	1359510 S	5/2009
JP	1359511 S	5/2009
JP	1361541 S	6/2009
JP	1380393 S	2/2010

* cited by examiner

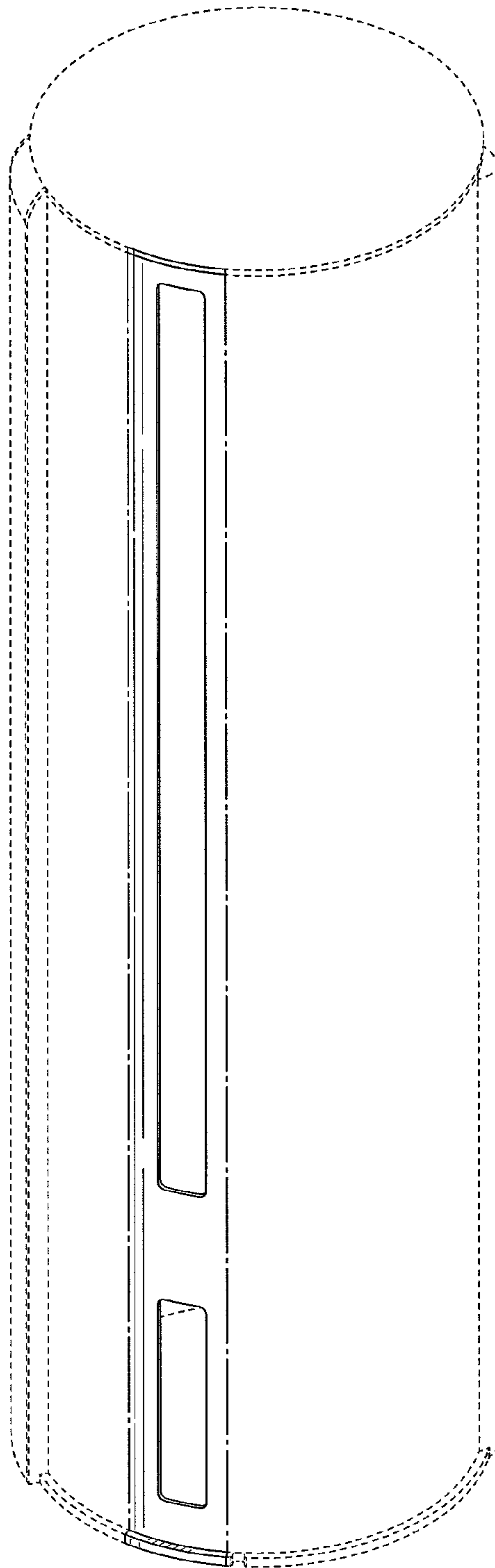

FIG. 1

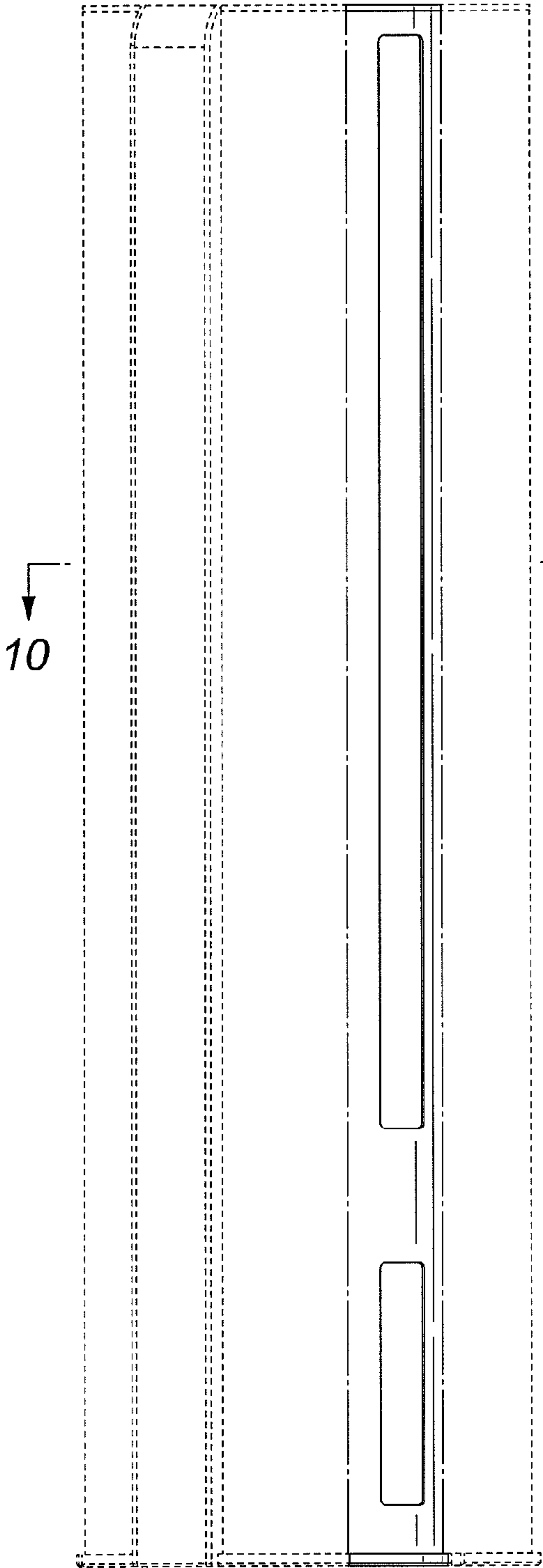

FIG. 2

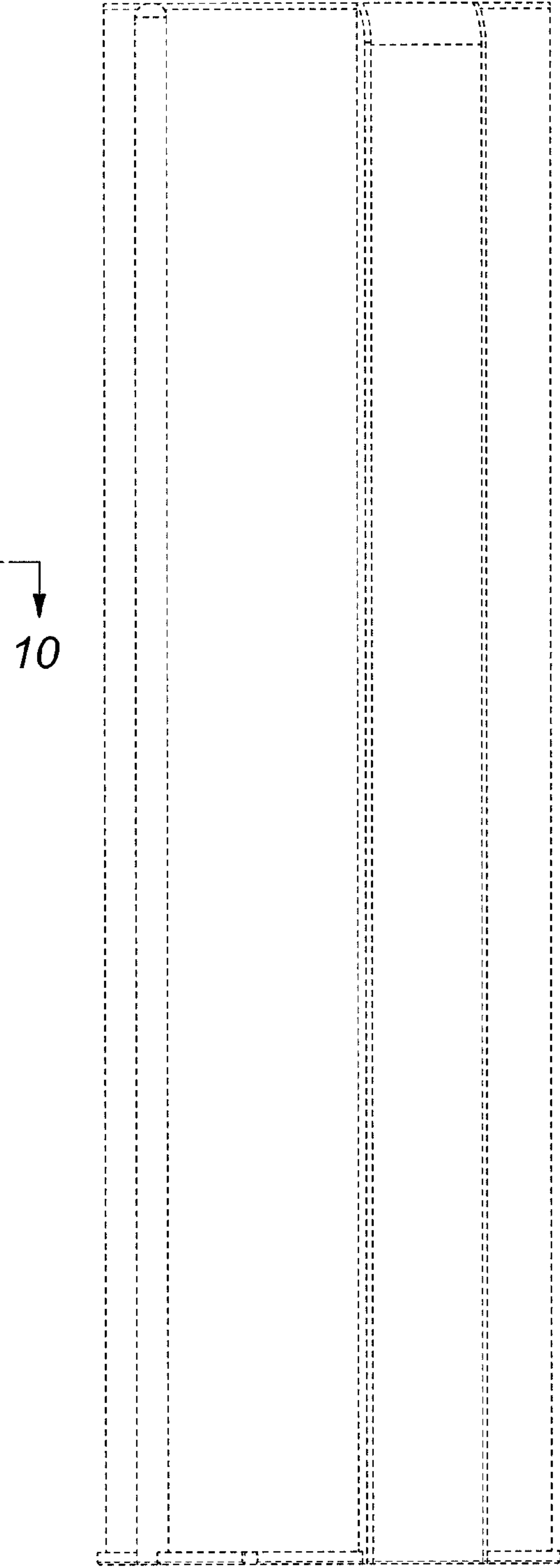

FIG. 3

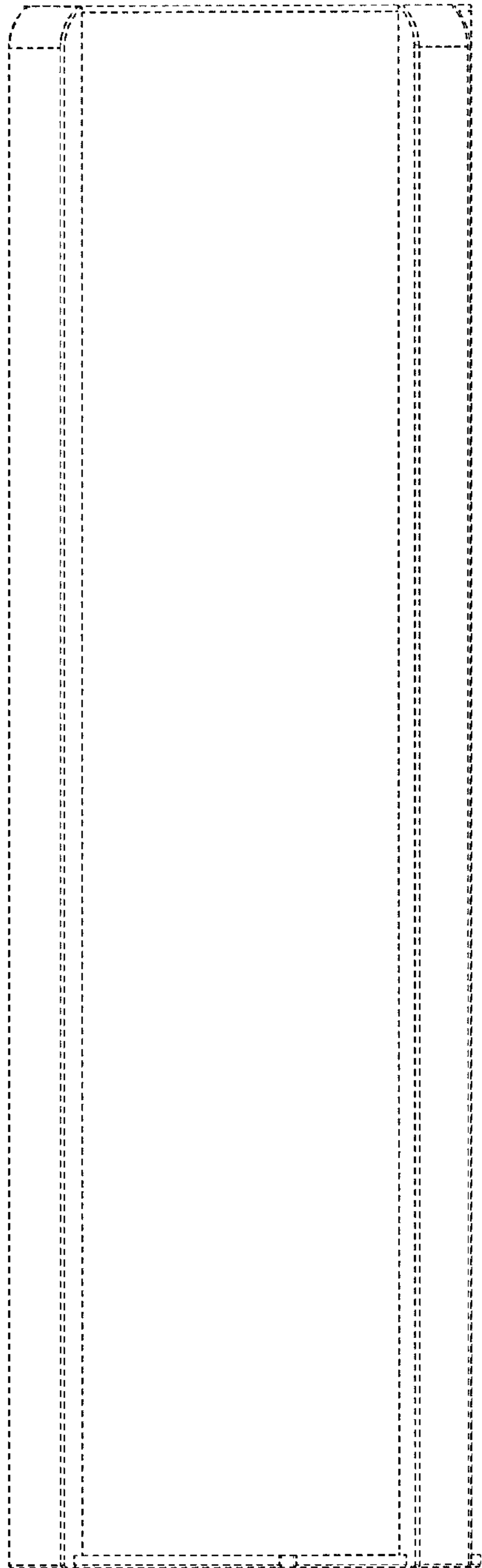

FIG. 4

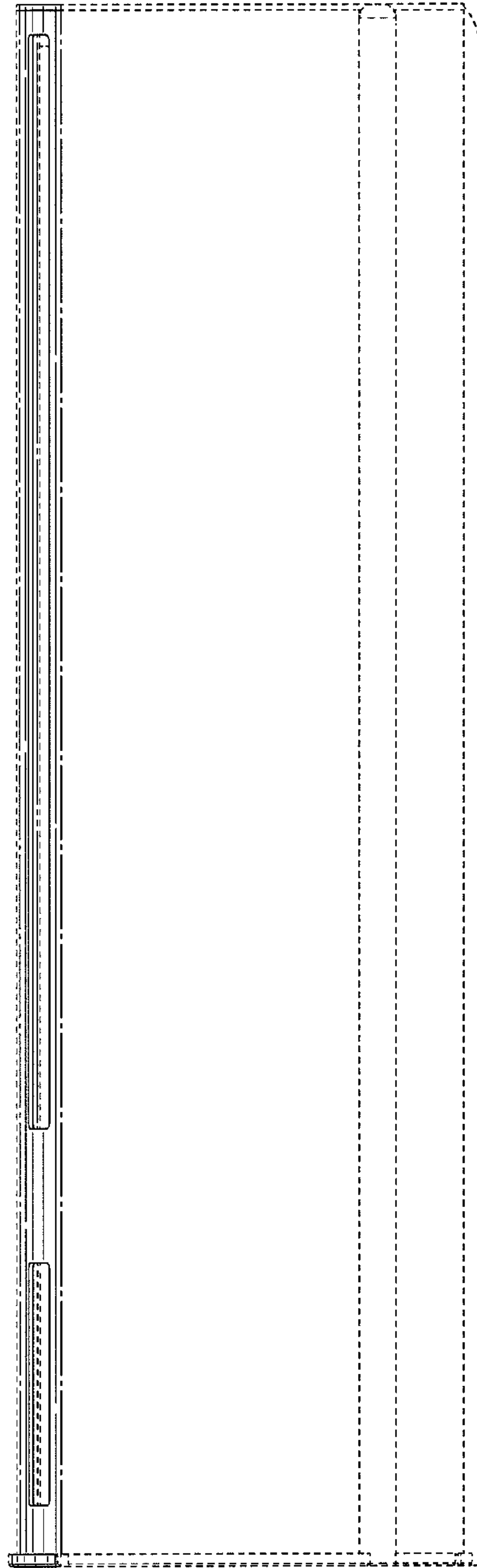

FIG. 5

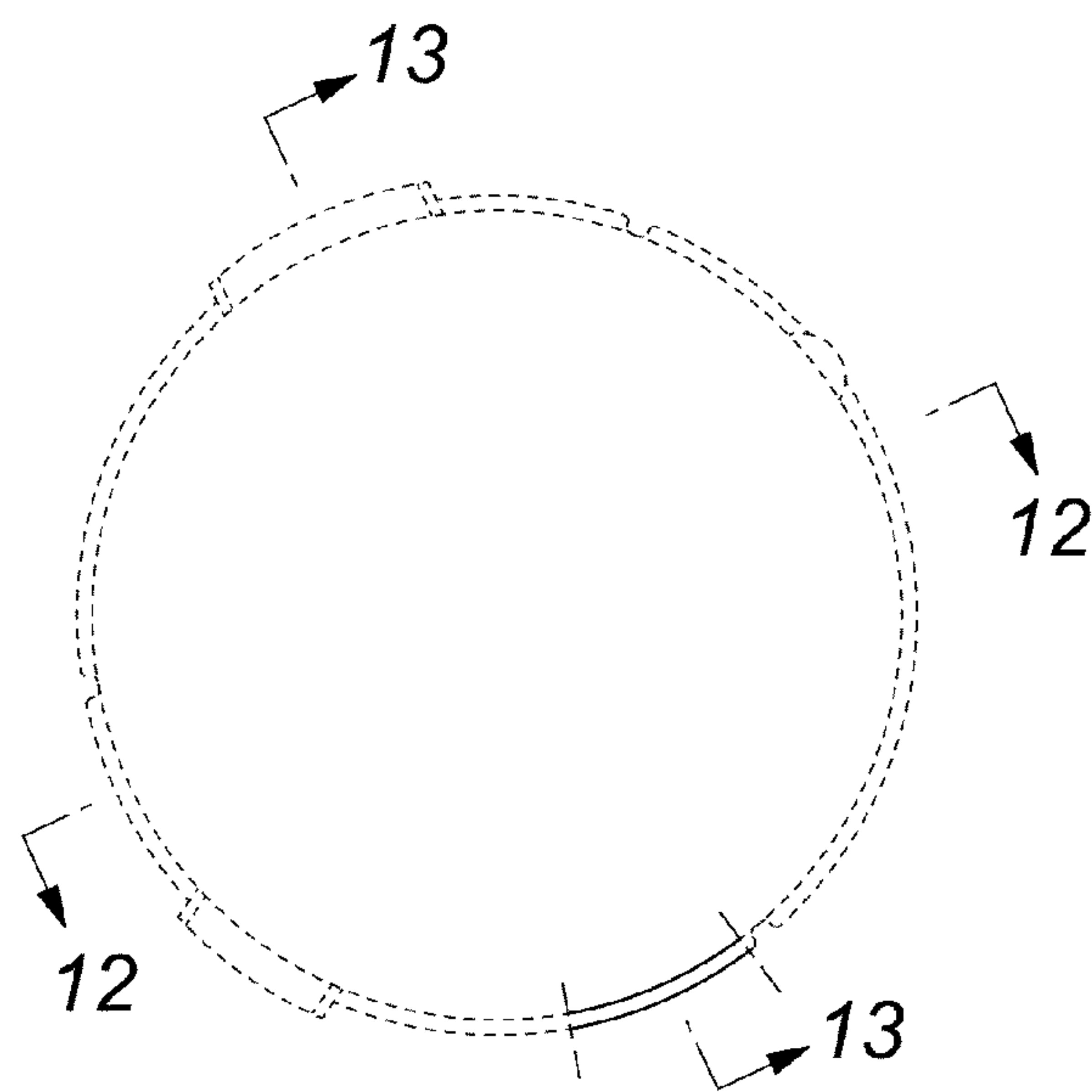

FIG. 6

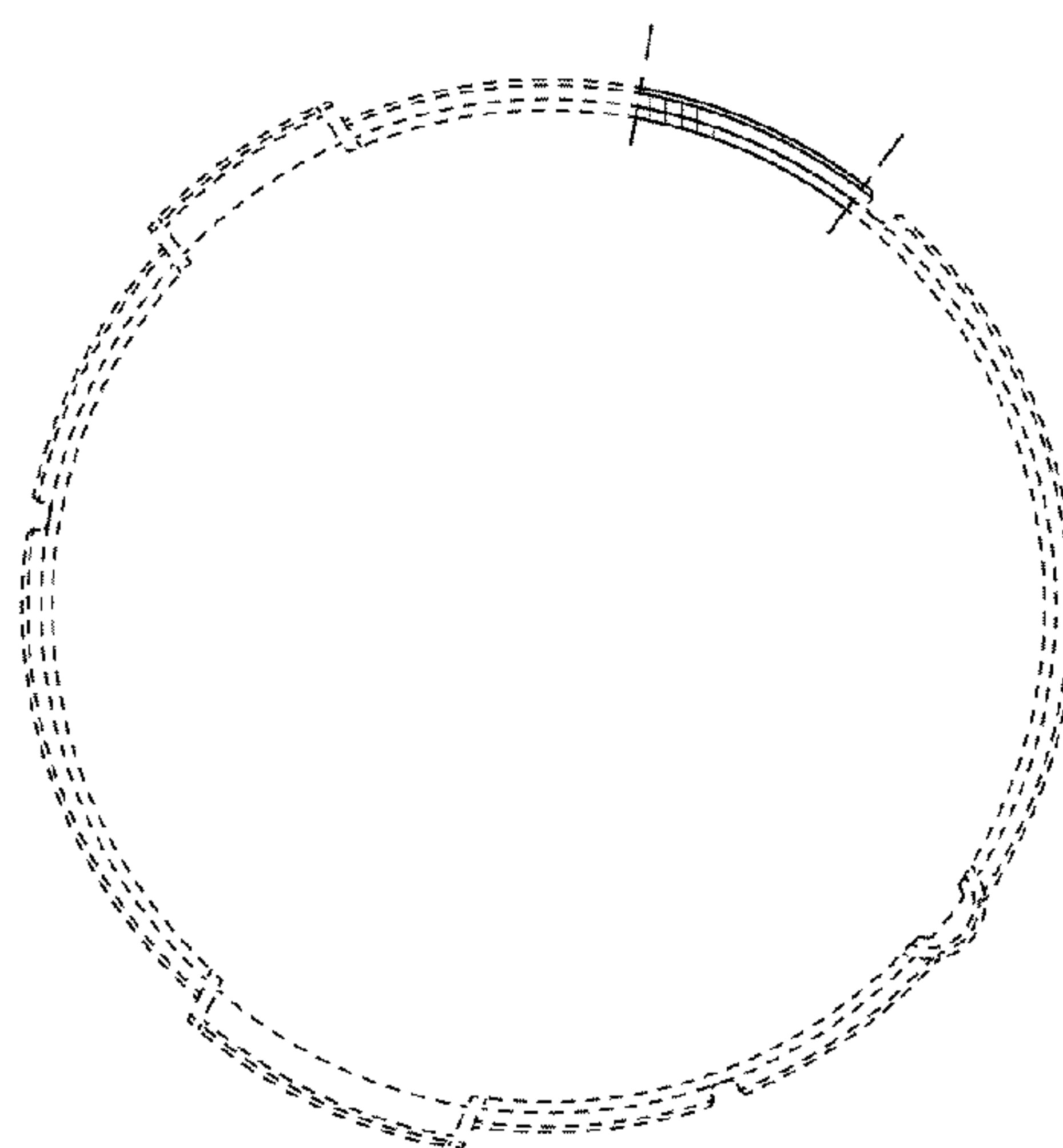

FIG. 7

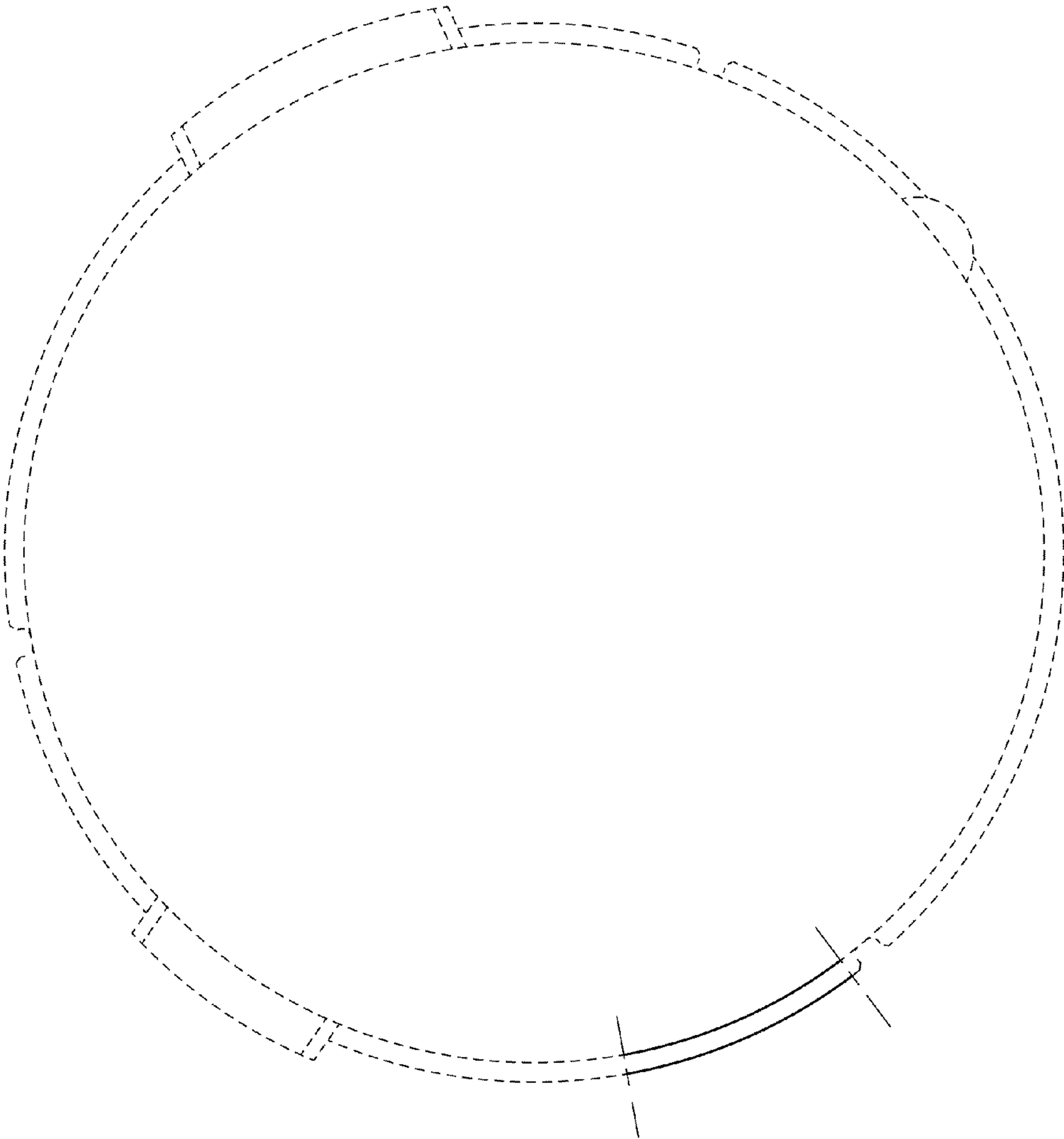

FIG. 8

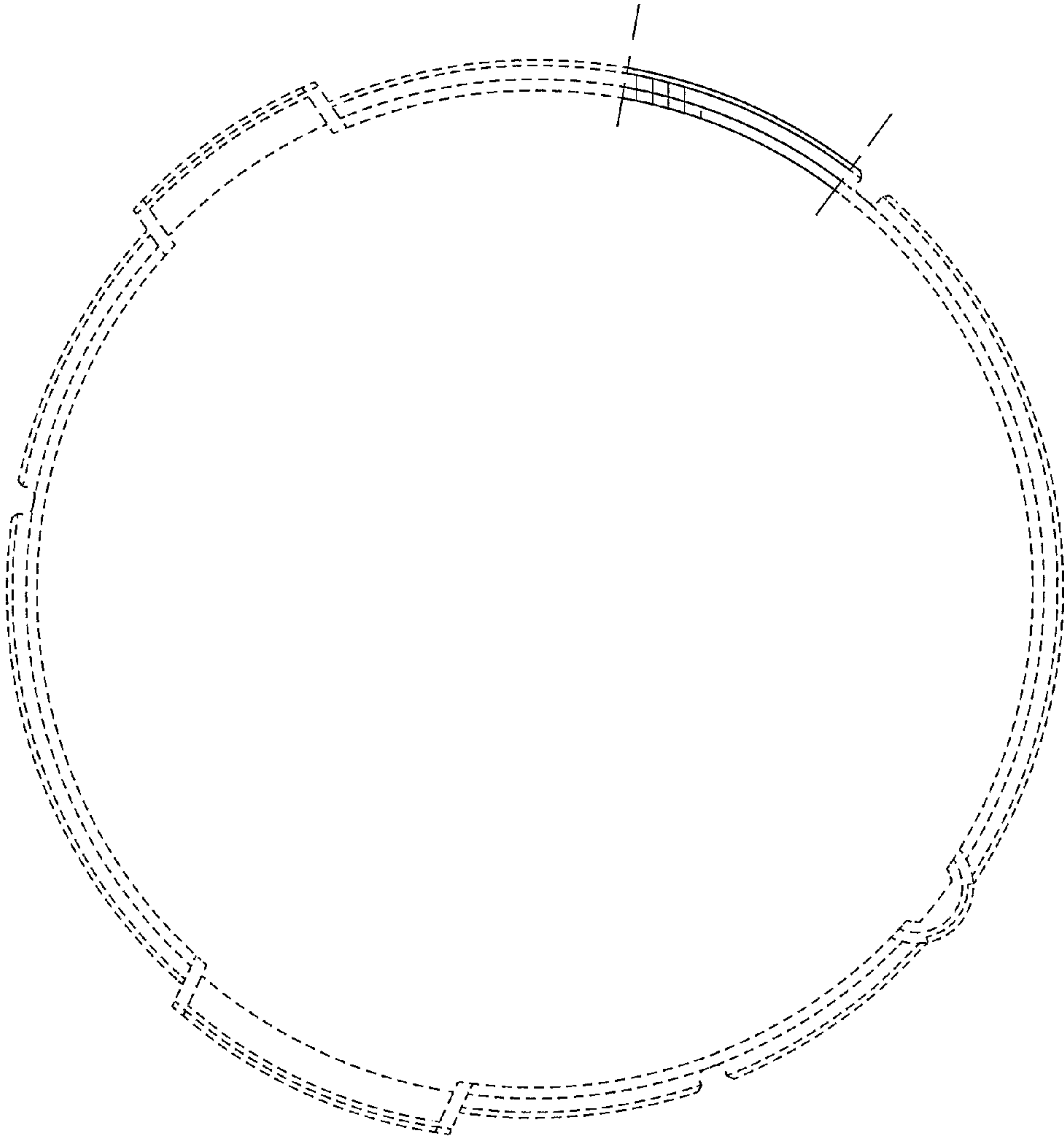

FIG. 9

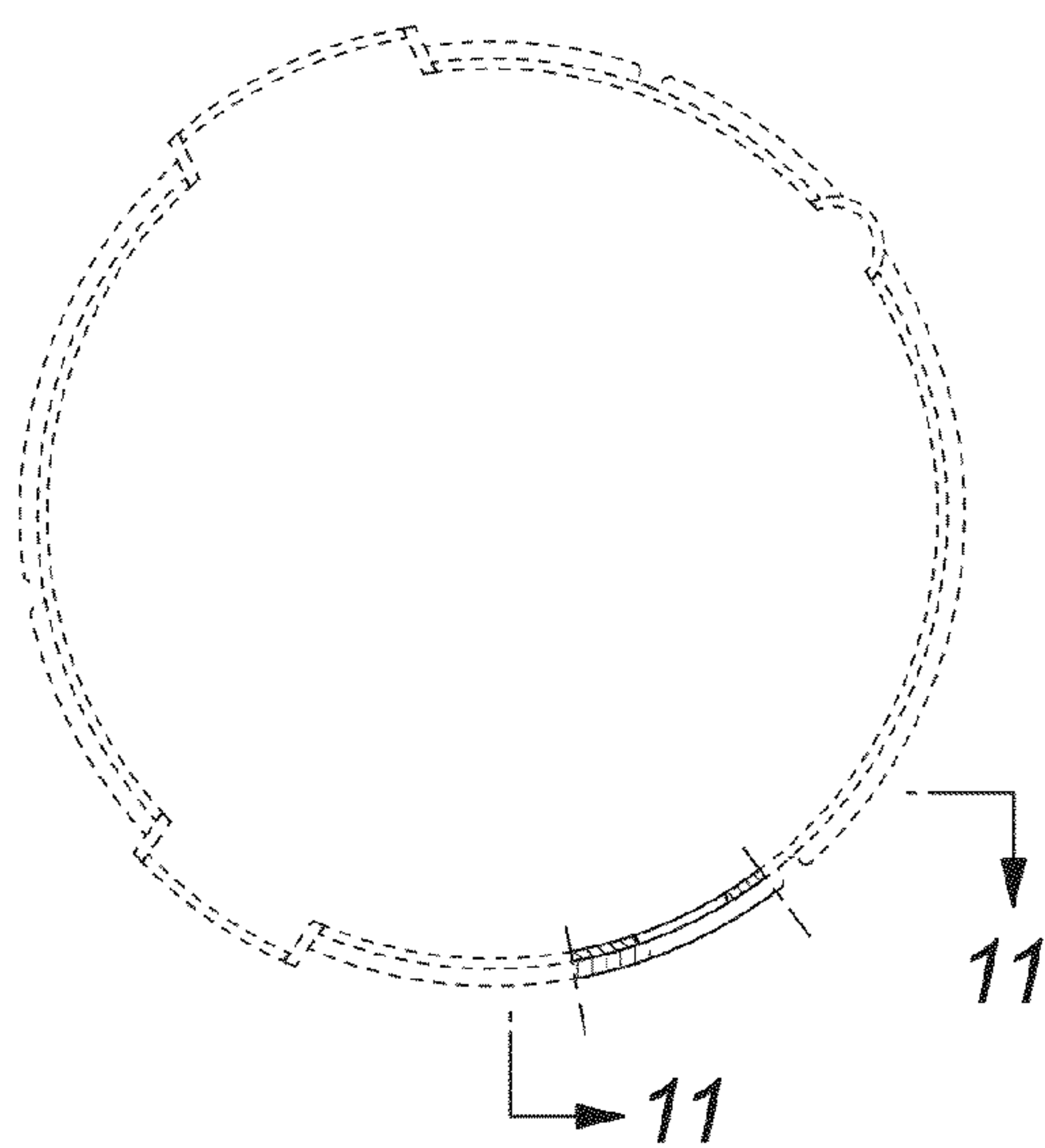

FIG. 10

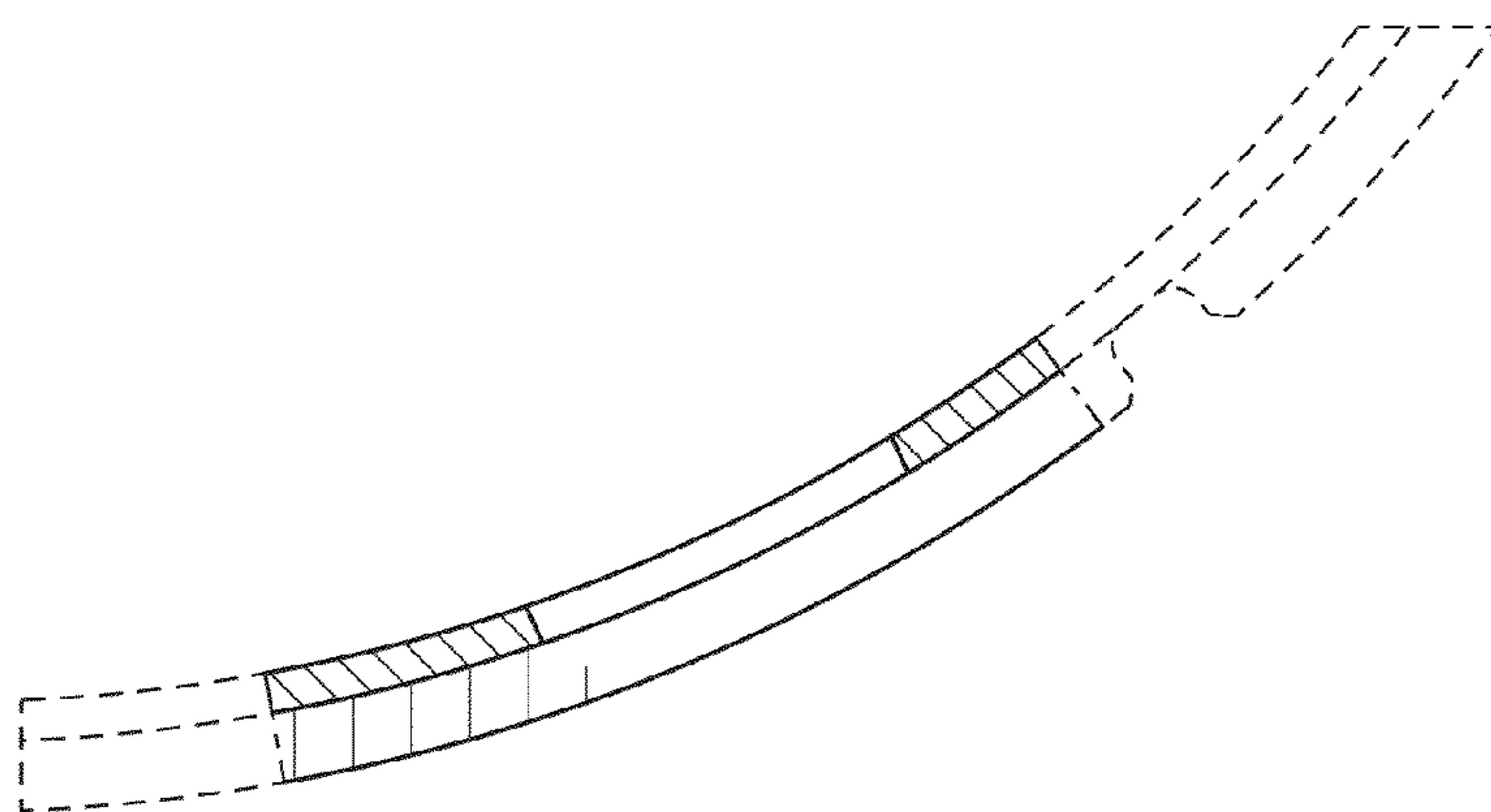

FIG. 11

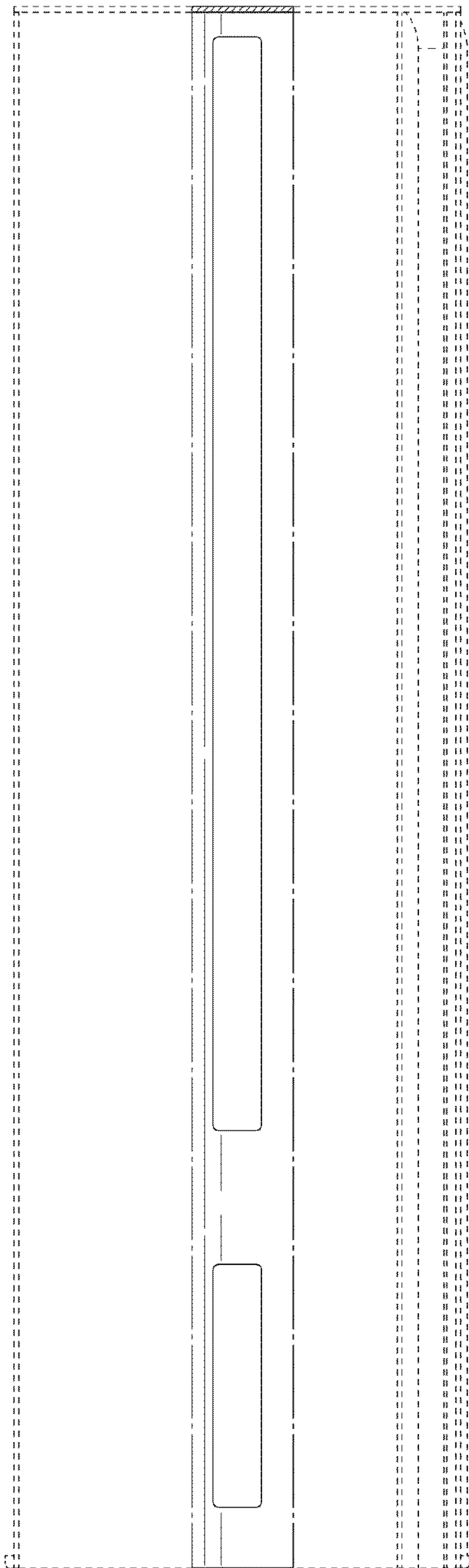

FIG. 12

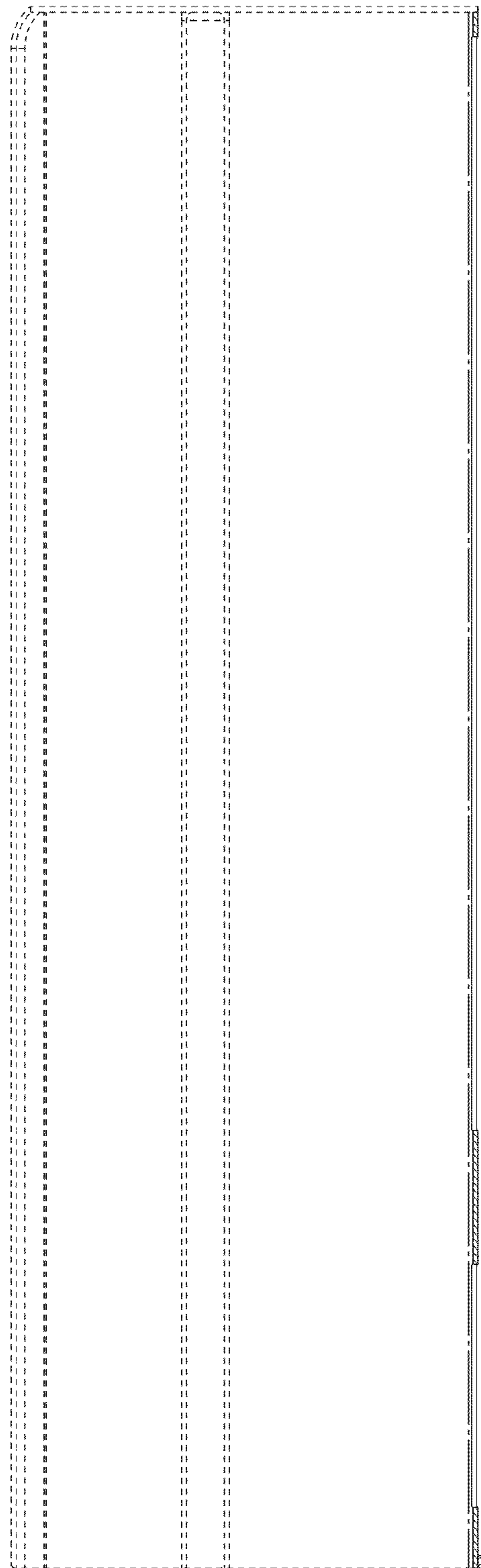

FIG. 13