



US00D718866S

(12) **United States Design Patent Law**

(10) **Patent No.:** **US D718,866 S**
(45) **Date of Patent:** **** Dec. 2, 2014**

(54) **HEART RATE BELT**

(71) Applicant: **Ricky Wai Kin Law**, Tsuen Wan (HK)

(72) Inventor: **Ricky Wai Kin Law**, Tsuen Wan (HK)

(73) Assignee: **Latitude Limited**, New Territories (HK)

(**) Term: **14 Years**

(21) Appl. No.: **29/446,861**

(22) Filed: **Feb. 27, 2013**

(51) **LOC (10) Cl.** **24-01**

(52) **U.S. Cl.**
USPC **D24/167**

(58) **Field of Classification Search**
USPC D24/165-168, 186, 187; D10/46, 70,
D10/98; 600/301, 382, 390, 483, 500-503,
600/508, 509, 513
See application file for complete search history.

(56) **References Cited**

U.S. PATENT DOCUMENTS

4,911,169 A * 3/1990 Ferrari 600/384
D349,575 S * 8/1994 Columbo D24/167
6,272,365 B1 * 8/2001 Ronkainen et al. 600/390

D595,858 S * 7/2009 Kazel D24/186
D597,676 S * 8/2009 Copeland et al. D24/187
D603,521 S * 11/2009 Lindberg et al. D24/187
D619,256 S * 7/2010 Brady et al. D24/167
D639,955 S * 6/2011 Riobo Aboy et al. D24/165
D667,127 S * 9/2012 Lindberg et al. D24/187
D676,137 S * 2/2013 Lindberg et al. D24/187
2005/0075577 A1 * 4/2005 Chen 600/509
2007/0055120 A1 * 3/2007 Juan 600/392
2012/0238890 A1 * 9/2012 Baker et al. 600/509

* cited by examiner

Primary Examiner — Anhdao Doan

(74) *Attorney, Agent, or Firm* — Rabin & Berdo, P.C.

(57) **CLAIM**

The ornamental design for a heart rate belt, as shown and described.

DESCRIPTION

FIG. 1 is a perspective view of a heart rate belt according to a new design;
FIG. 2 is a top view thereof;
FIG. 3 is a side view thereof;
FIG. 4 is a bottom view thereof;
FIG. 5 is another side view thereof;
FIG. 6 is an end view thereof; and,
FIG. 7 is another end view thereof.

1 Claim, 4 Drawing Sheets

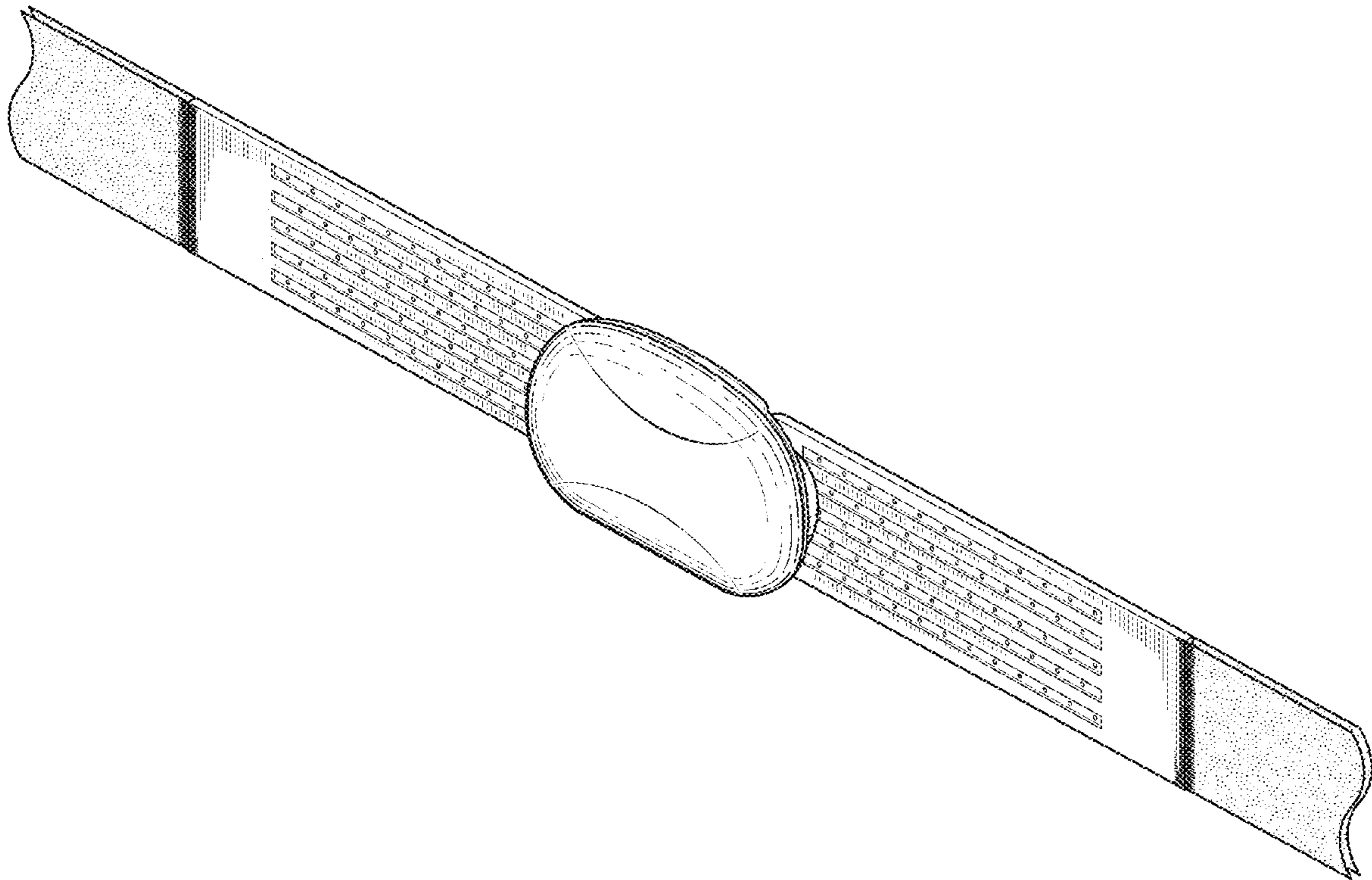

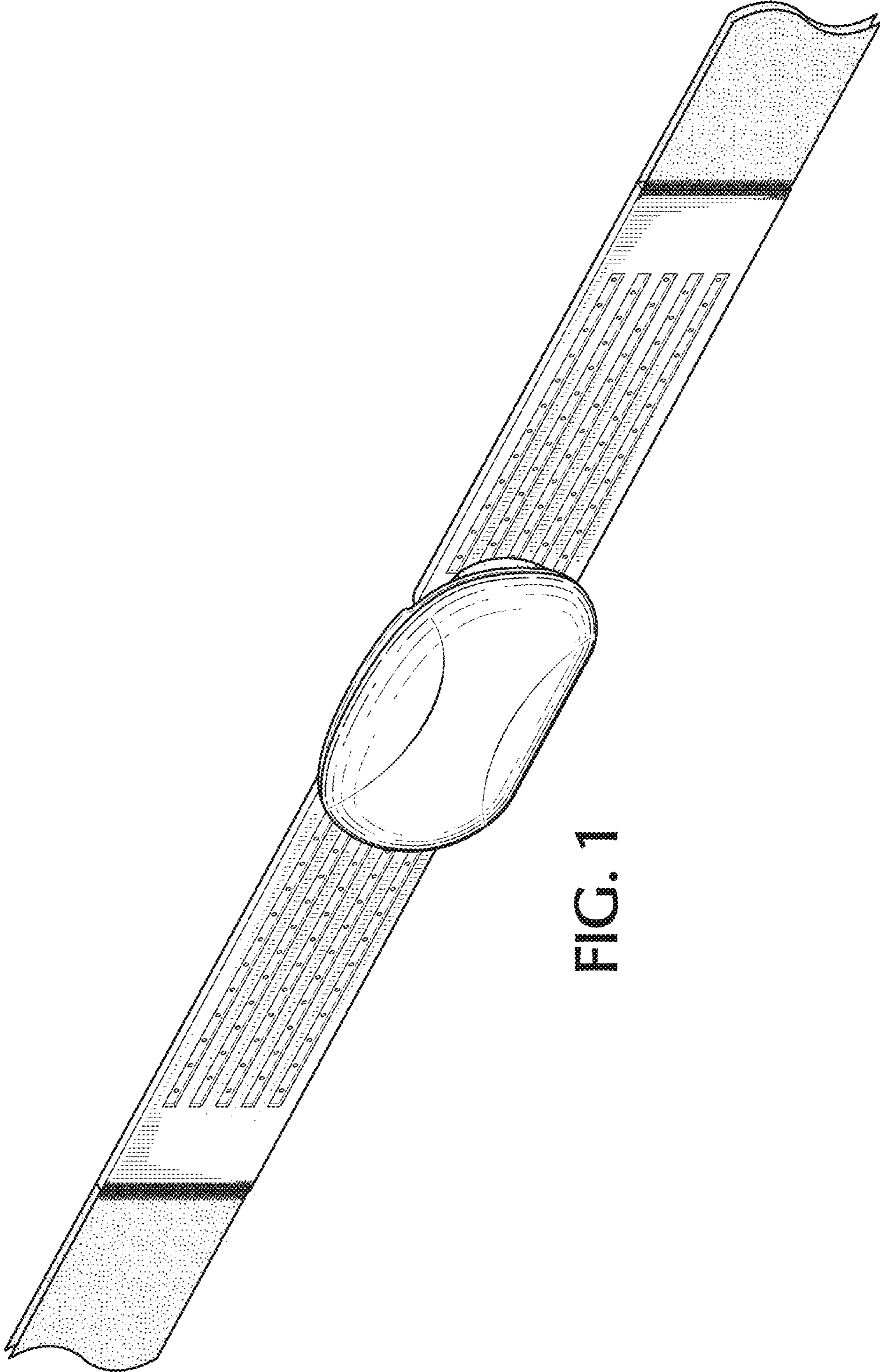

FIG. 1

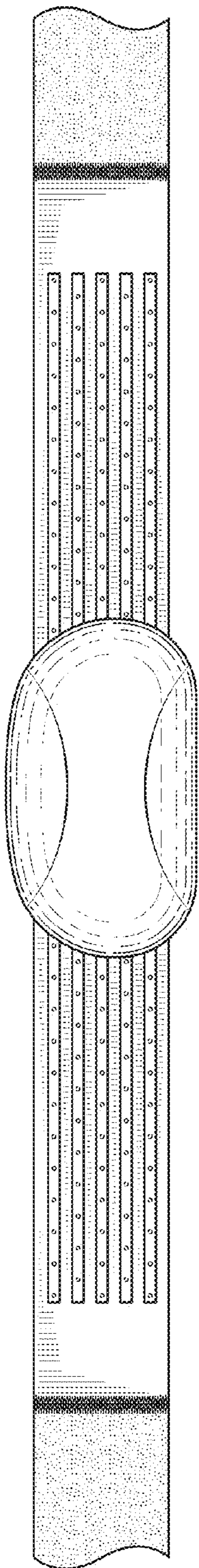

FIG. 2

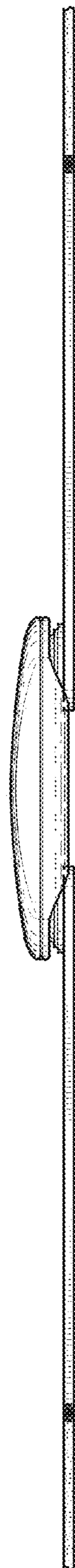

FIG. 3

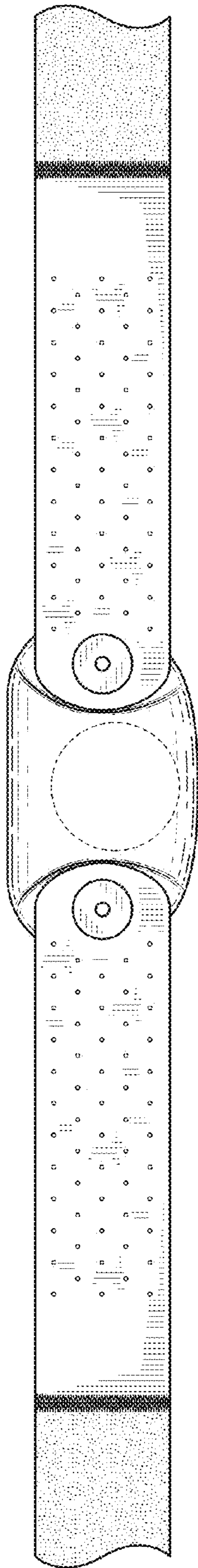

FIG. 4



FIG. 5



FIG. 7



FIG. 6

UNITED STATES PATENT AND TRADEMARK OFFICE
CERTIFICATE OF CORRECTION

PATENT NO. : D718,866 S
APPLICATION NO. : 29/446861
DATED : December 2, 2014
INVENTOR(S) : Ricky Wai Kin Law

Page 1 of 5

It is certified that error appears in the above-identified patent and that said Letters Patent is hereby corrected as shown below:

On the Title Page

Correct Figure for Publication with the attached Figures.

In the Drawings

Sheets 1-4, replace with the attached 4 Replacement Sheets (Figures 1-7).

Signed and Sealed this
Ninth Day of May, 2017

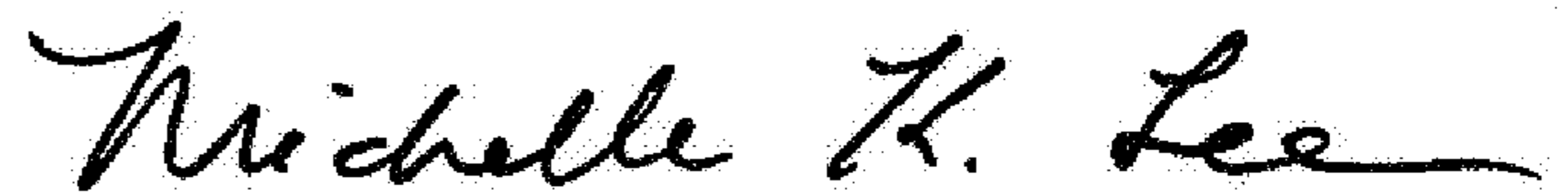

Michelle K. Lee
Director of the United States Patent and Trademark Office

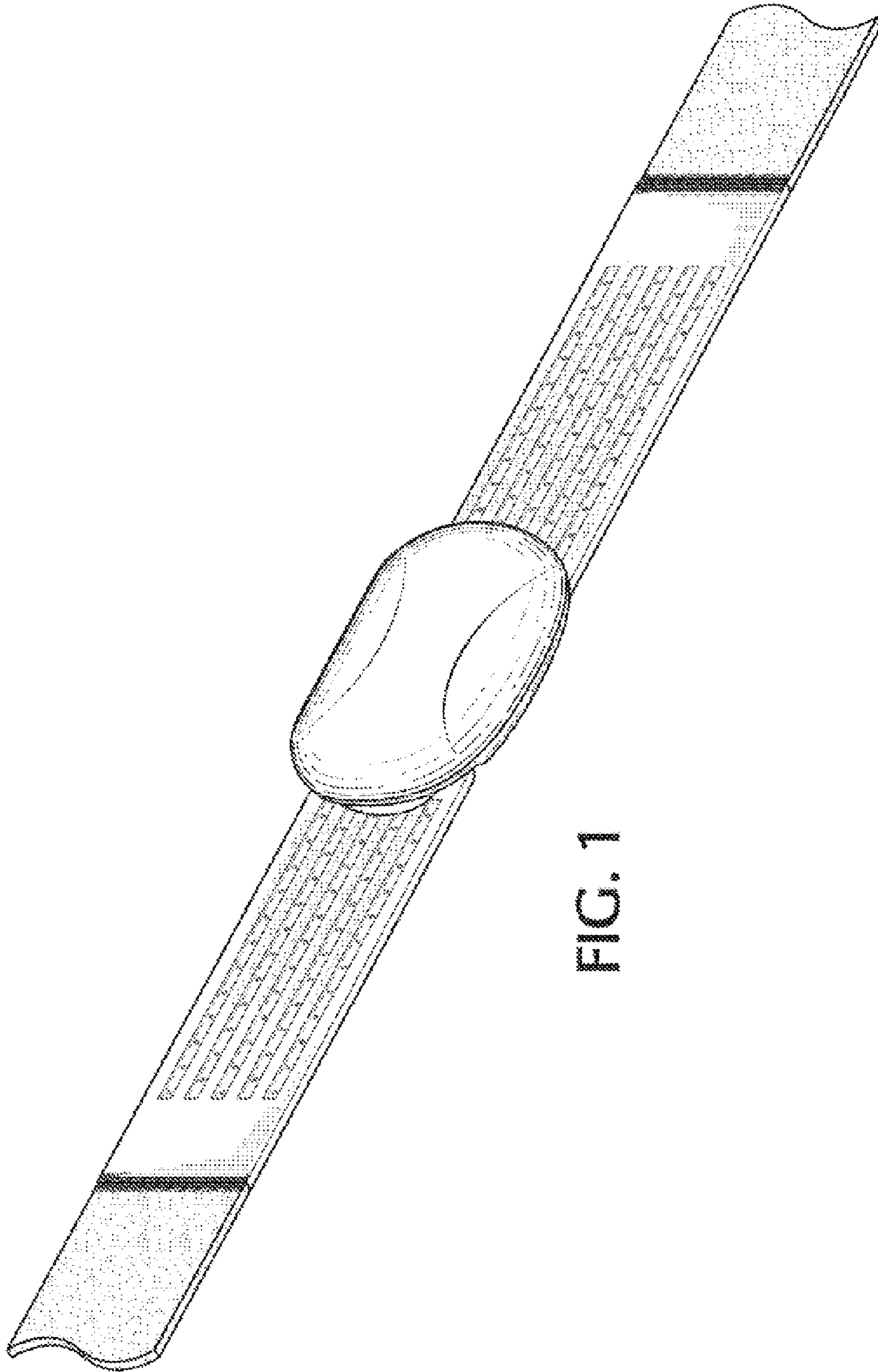

FIG. 1

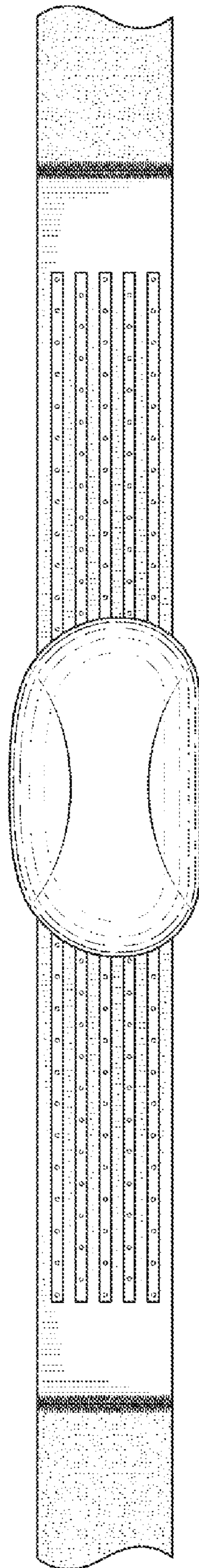

FIG. 2

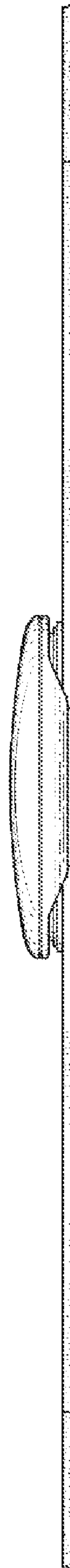

FIG. 3

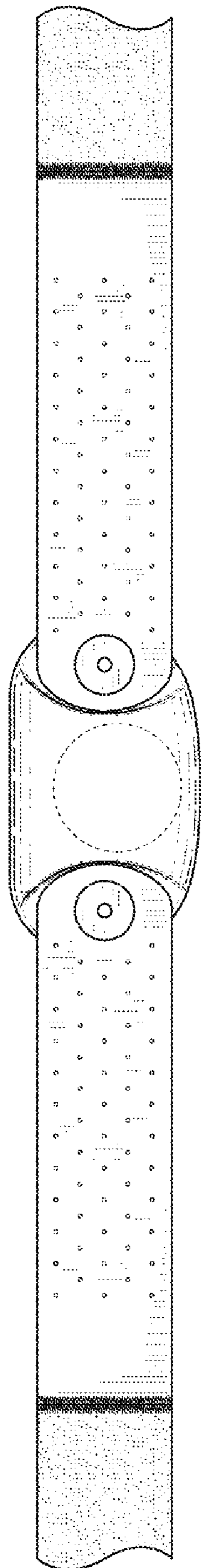

FIG. 4

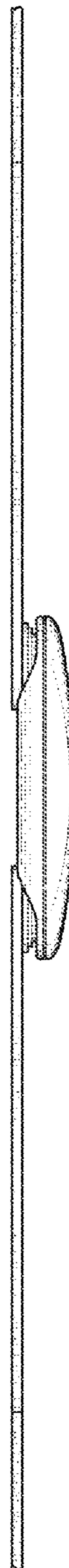

FIG. 5

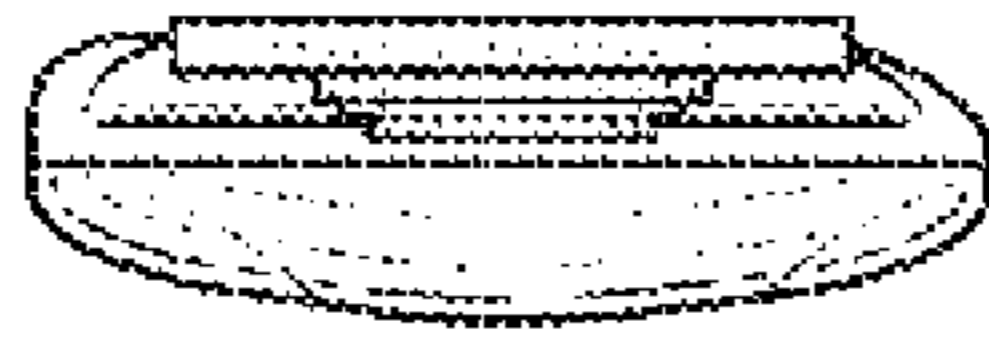

FIG. 7

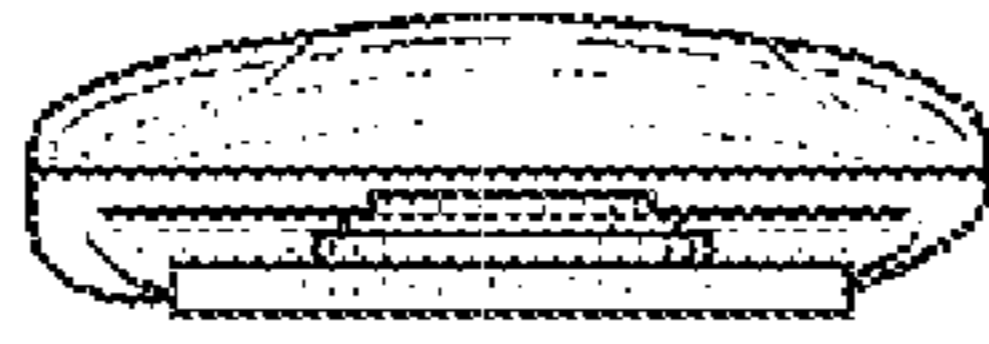

FIG. 6