



US00D718859S

(12) **United States Design Patent**  
**Pohlmann et al.**

(10) **Patent No.:** **US D718,859 S**

(45) **Date of Patent:** **\*\* Dec. 2, 2014**

(54) **DENTAL SCALER**

(71) Applicant: **American Eagle Instruments, Inc.**,  
Missoula, MT (US)

(72) Inventors: **Stephen Pohlmann**, Tel Aviv (IL);  
**Dennis Meuchel**, Missoula, MT (US)

(73) Assignee: **American Eagle Instruments, Inc.**,  
Missoula, MT (US)

(\*\*) Term: **14 Years**

(21) Appl. No.: **29/453,906**

(22) Filed: **May 3, 2013**

(51) **LOC (10) Cl.** ..... **24-02**

(52) **U.S. Cl.**  
USPC ..... **D24/152**

(58) **Field of Classification Search**  
USPC ..... D24/146–147, 149, 152, 154, 144;  
433/2–3, 82, 102, 118–119, 86, 152,  
433/142, 165–166, 141, 143  
See application file for complete search history.

(56) **References Cited**

**U.S. PATENT DOCUMENTS**

4,283,174	A *	8/1981	Sertich	433/119
4,283,175	A *	8/1981	Nash	433/119
D275,992	S *	10/1984	Detsch	D24/152
4,731,019	A *	3/1988	Martin	433/119
4,743,198	A *	5/1988	Kennedy	433/143
5,577,911	A *	11/1996	Garfinkel	433/119
5,682,665	A *	11/1997	Svanberg	433/143

6,007,333	A *	12/1999	Callan et al.	433/143
6,382,974	B1 *	5/2002	Garfinkel	433/141
D558,347	S *	12/2007	Darnold et al.	D24/152
D698,922	S *	2/2014	Kawasaki	D24/152

\* cited by examiner

*Primary Examiner* — Wan Laymon

(74) *Attorney, Agent, or Firm* — Heslin Rothenberg Farley  
& Mesiti P.C.

(57) **CLAIM**

The ornamental design for a dental scaler, as shown and described.

**DESCRIPTION**

FIG. 1 is a front perspective view of a dental scaler comprising the new design;  
FIG. 2 is a back perspective view of the design of FIG. 1;  
FIG. 3 is a top view of the design of FIG. 1;  
FIG. 4 is a bottom view of the design of FIG. 1;  
FIG. 5 is a right side elevational view of the design of FIG. 1;  
FIG. 6 is a left elevational view of the design of FIG. 1;  
FIG. 7 is a front elevational view of the design of FIG. 1;  
FIG. 8 is a back elevational view of the design of FIG. 1; and,  
FIG. 9 is another perspective view of the dental scaler of FIG. 1.  
The broken lines in the figures are directed to environment and for illustrative purposes only; the broken lines form no part of the claimed design.

**1 Claim, 3 Drawing Sheets**

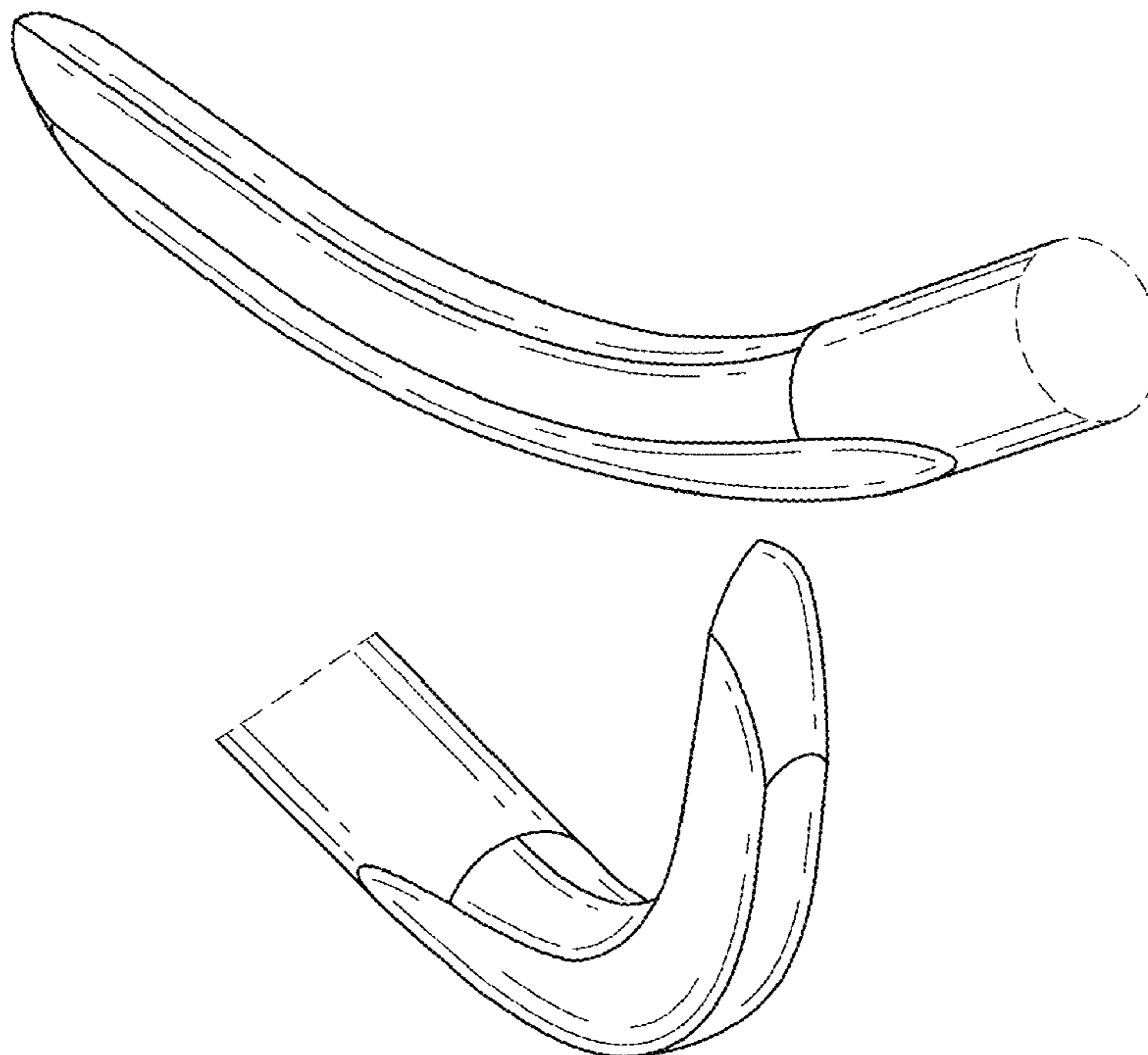

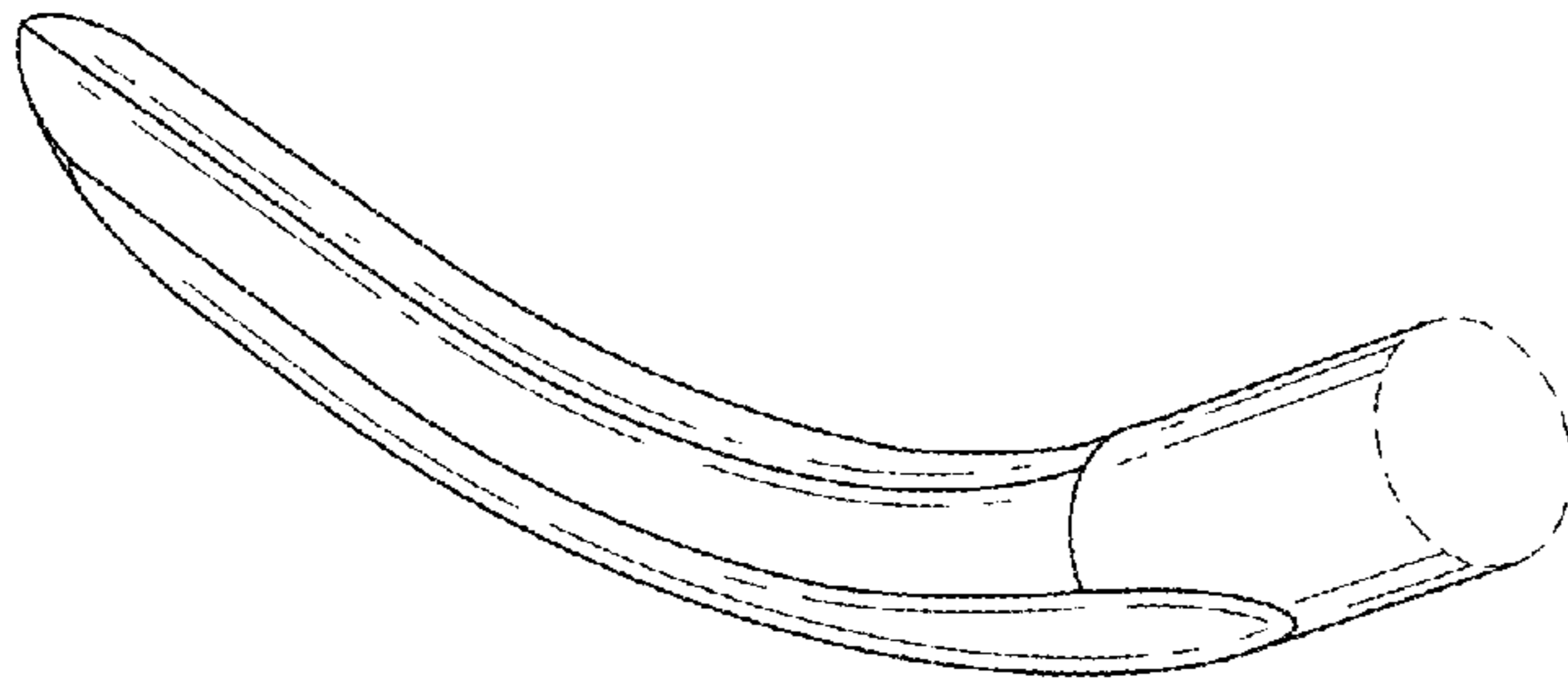

FIG. 1

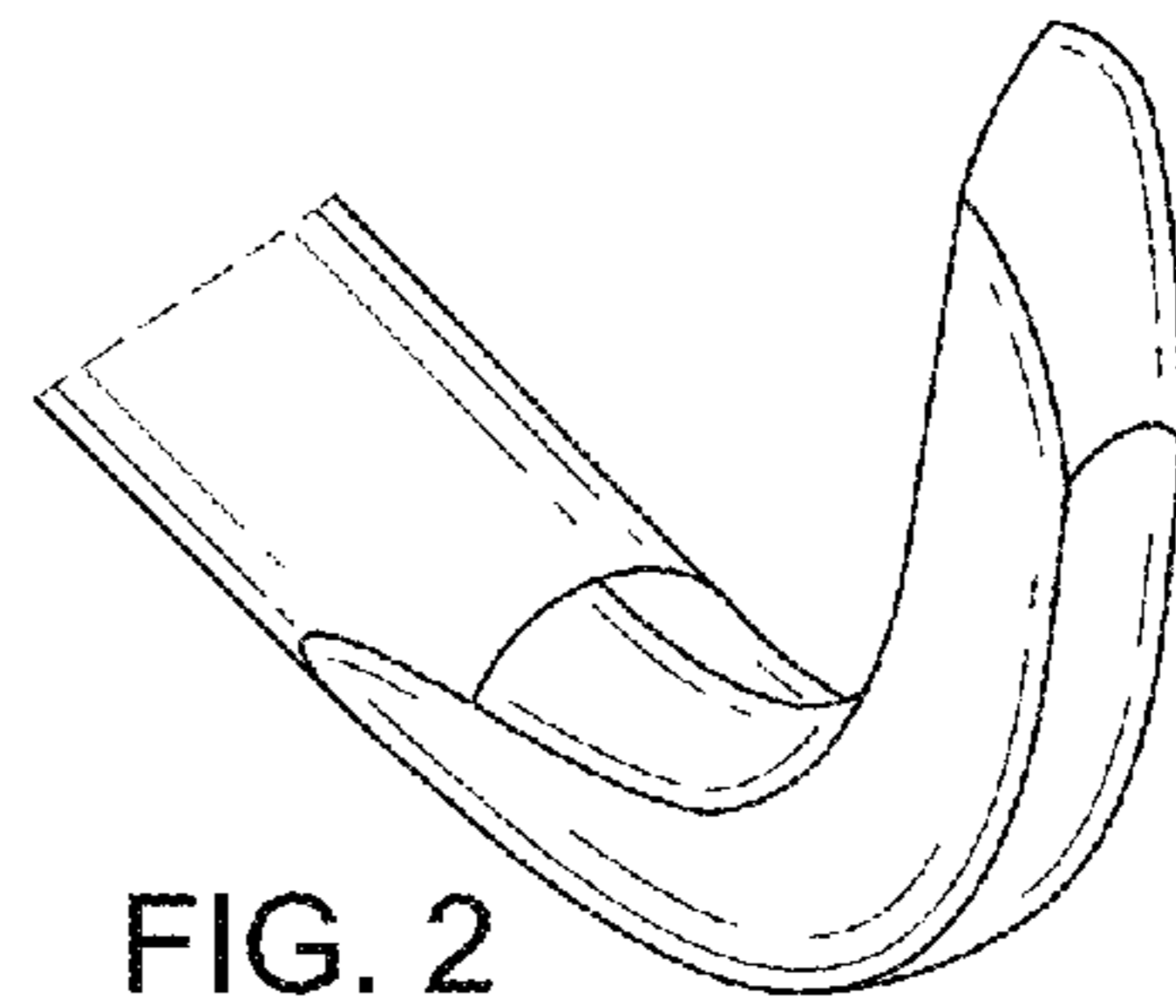

FIG. 2

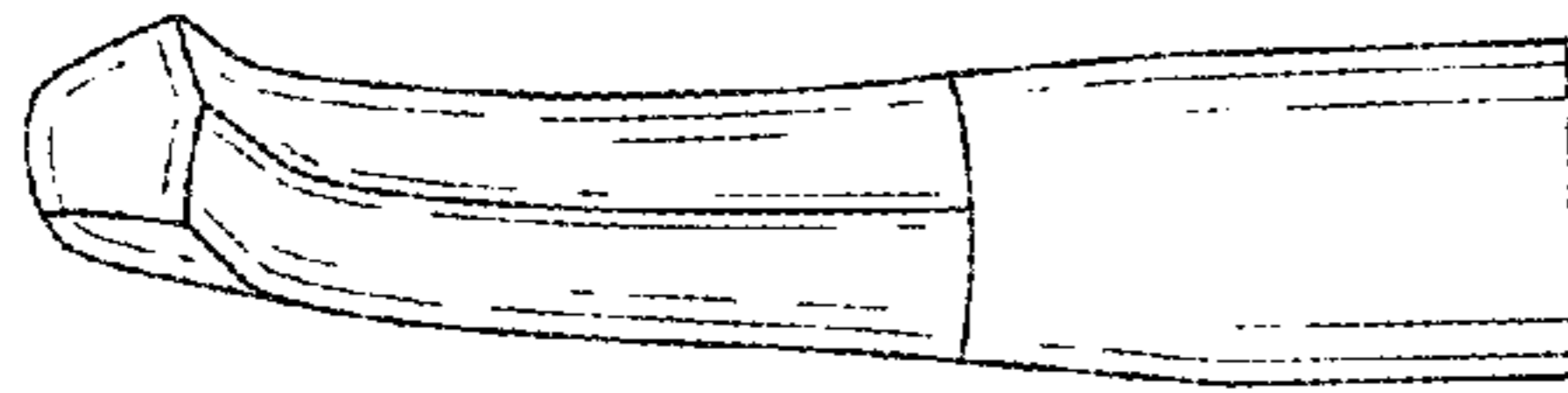

FIG. 3

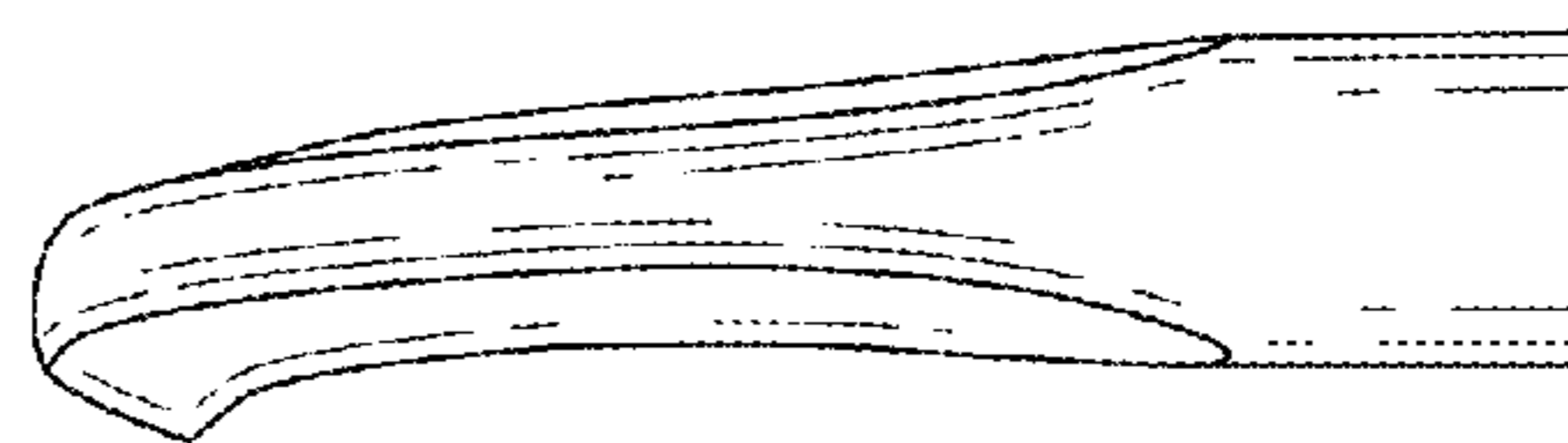

FIG. 4

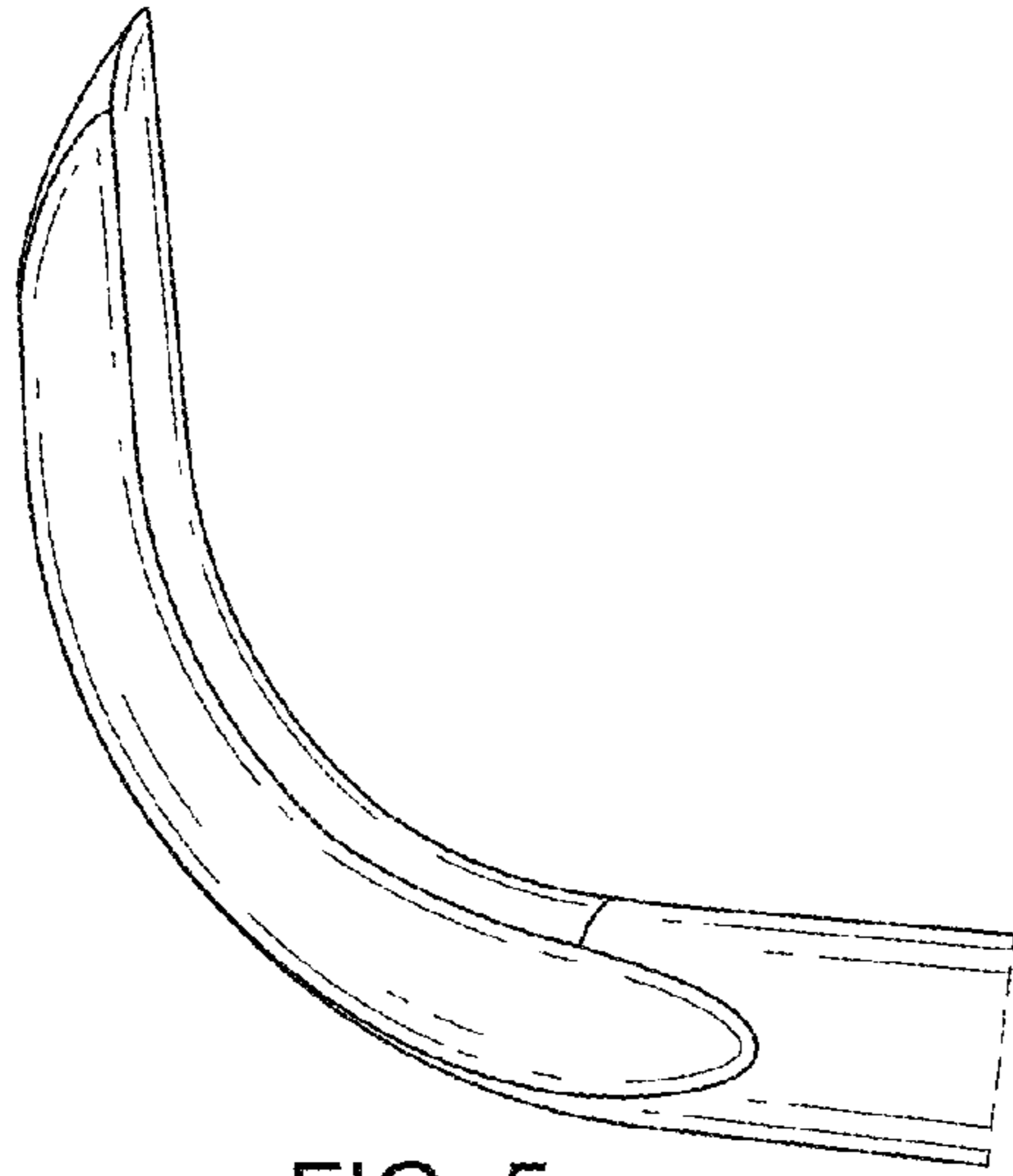

FIG. 5

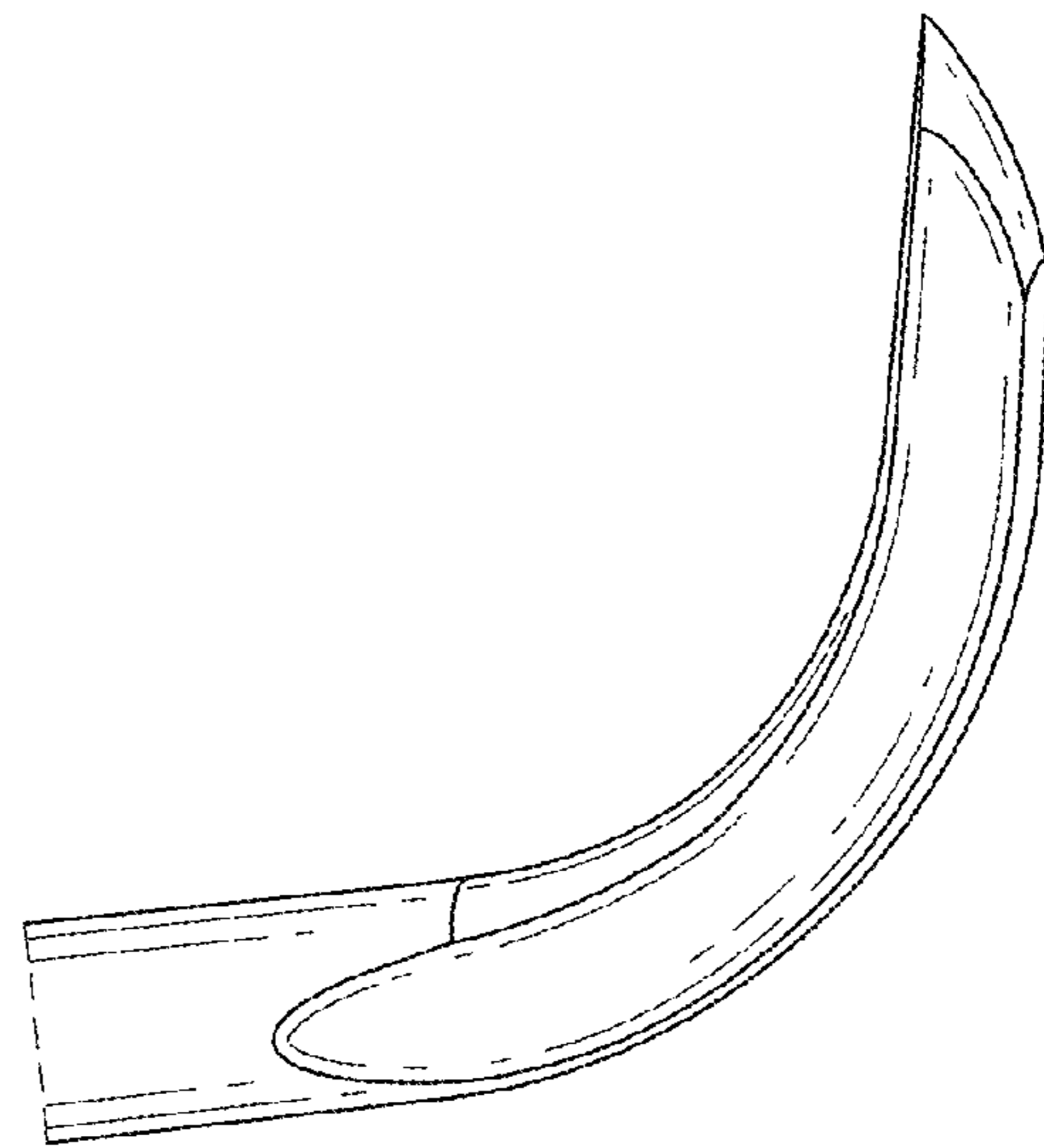

FIG. 6

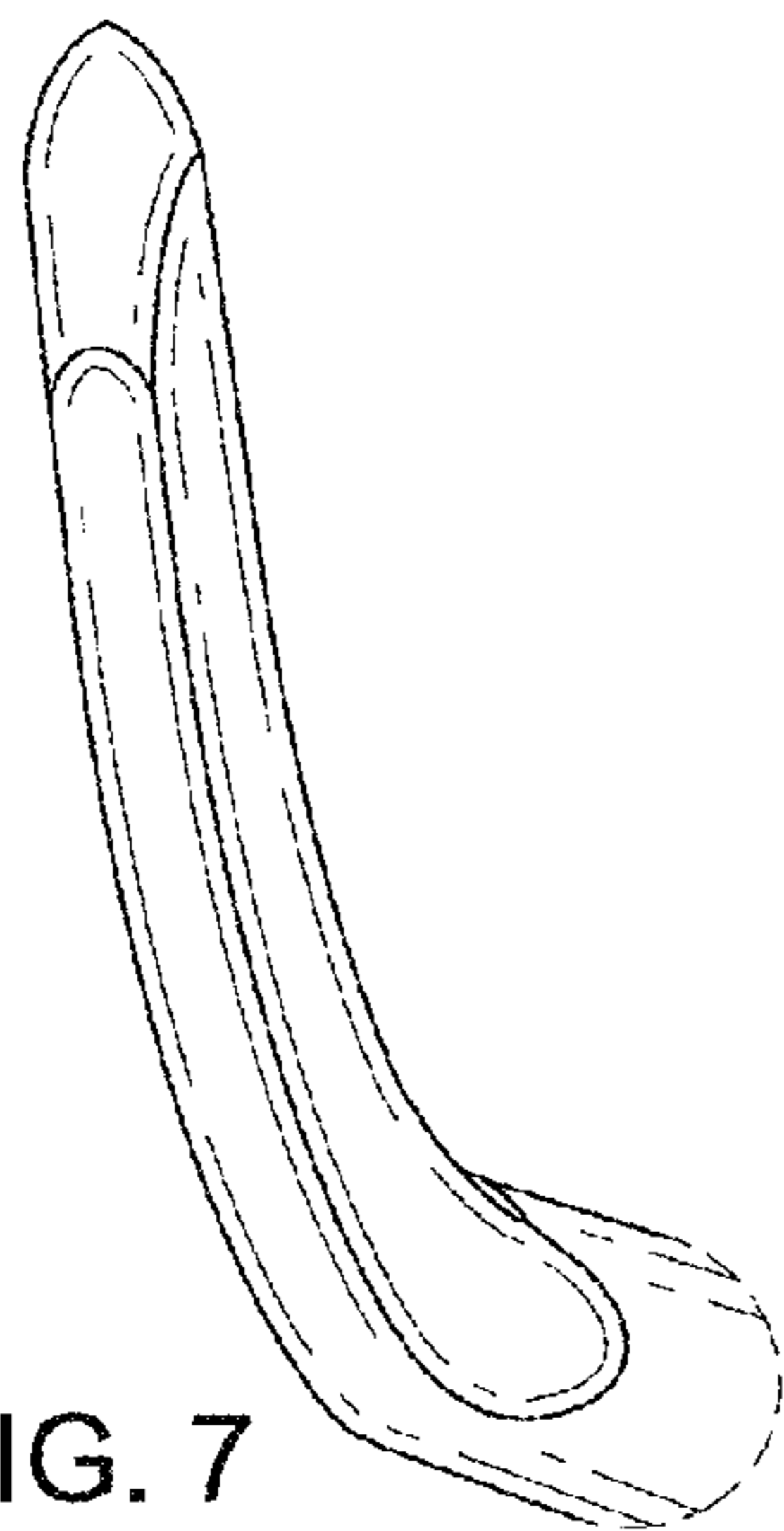

FIG. 7

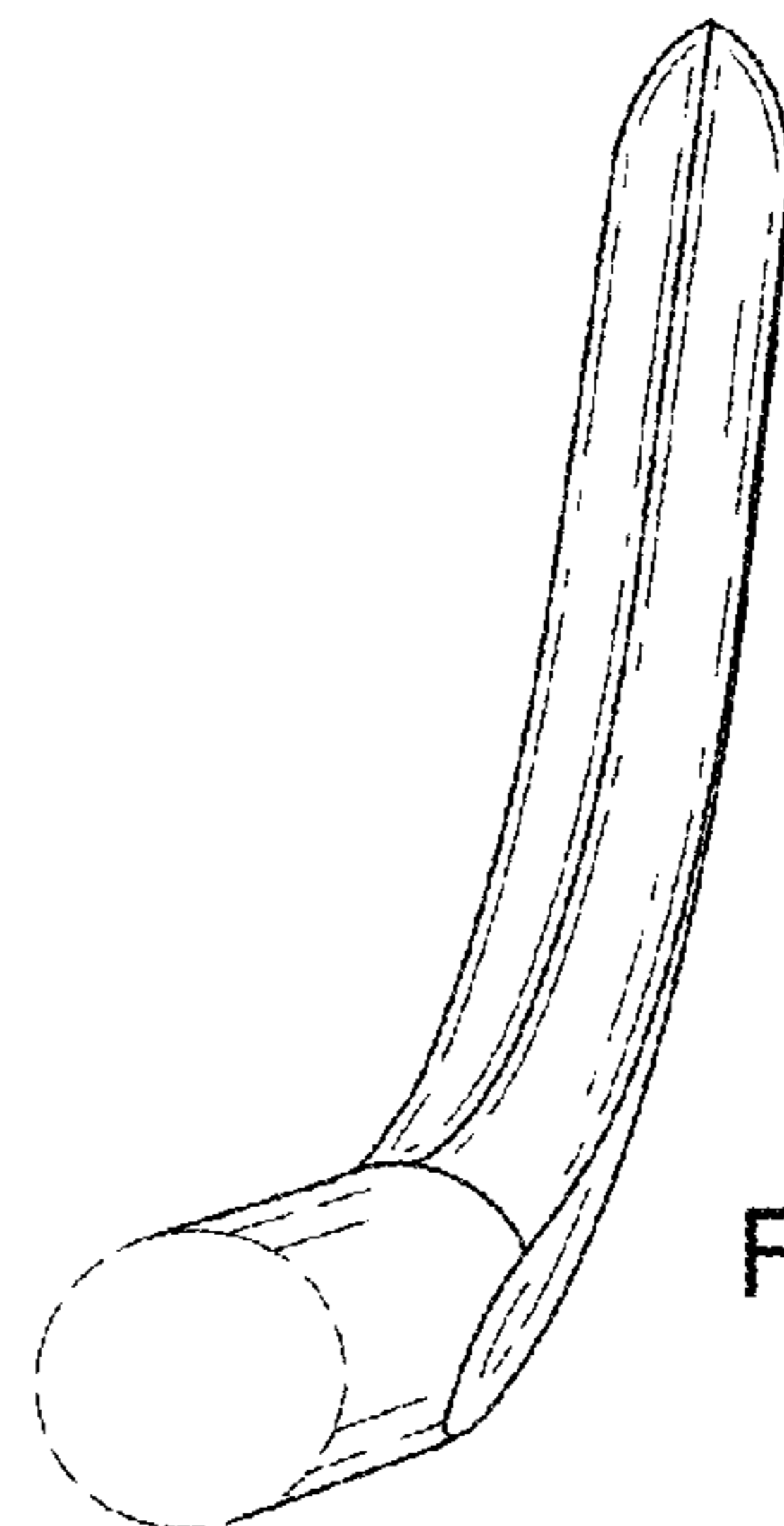

FIG. 8

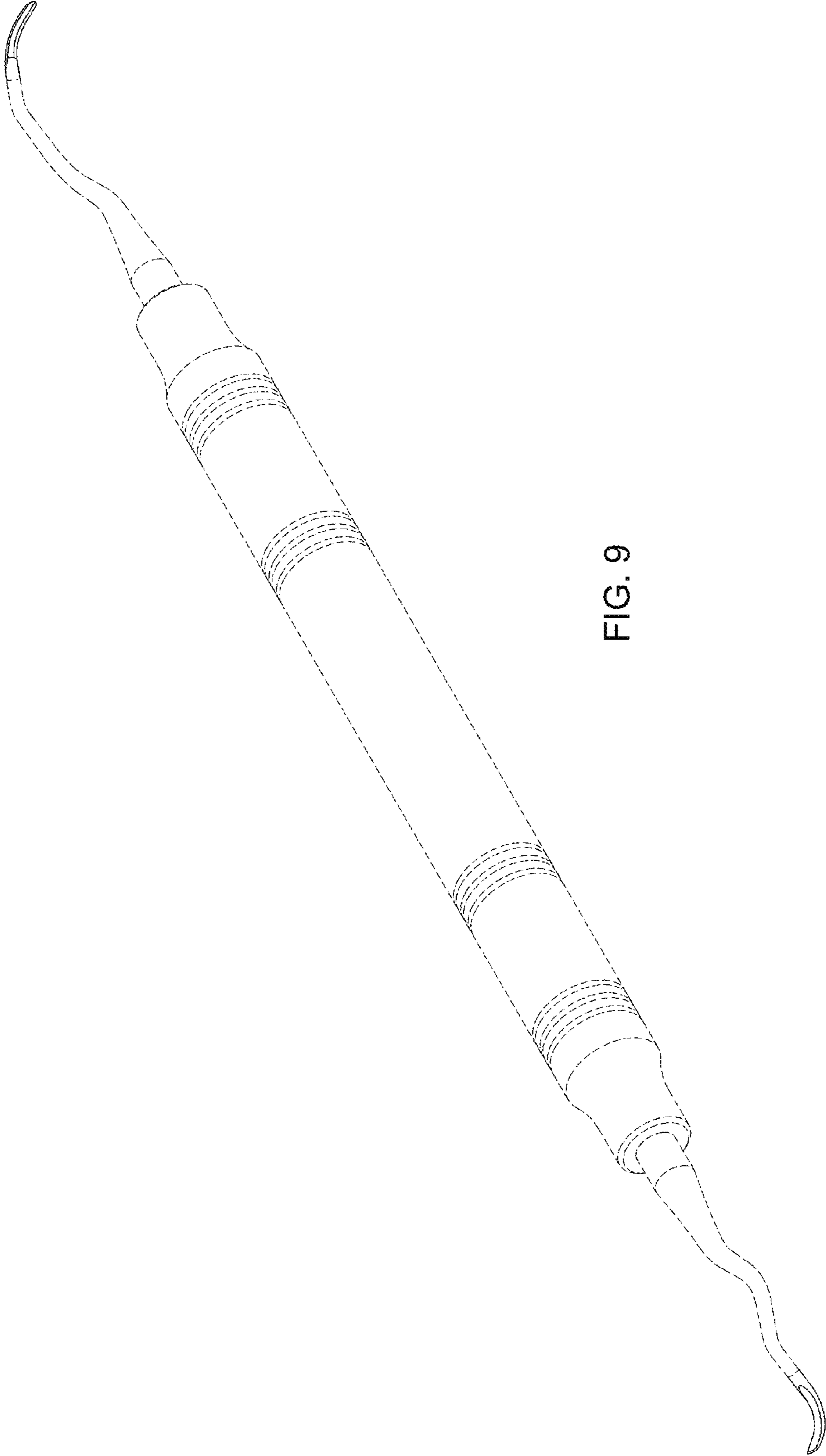

FIG. 9