



US00D718839S

(12) **United States Design Patent**
Garland

(10) **Patent No.:** **US D718,839 S**
(45) **Date of Patent:** **** Dec. 2, 2014**

(54) **FAUCET HANDLE**

(56) **References Cited**

(71) Applicant: **Masco Corporation of Indiana,**
Indianapolis, IN (US)

U.S. PATENT DOCUMENTS

(72) Inventor: **Celine Kwok Garland,** Zionsville, IN
(US)

D316,747 S *	5/1991	Fleischmann	D23/252
D346,644 S *	5/1994	Bonnell	D23/252
D460,532 S *	7/2002	Marcichow et al.	D23/252
D523,524 S *	6/2006	Schaffeld et al.	D23/249
D708,709 S *	7/2014	Yu	D23/238

(73) Assignee: **Masco Corporation of Indiana,**
Indianapolis, IN (US)

* cited by examiner

(**) Term: **14 Years**

Primary Examiner — Robert Delehanty

(21) Appl. No.: **29/488,862**

(74) *Attorney, Agent, or Firm* — Edgar A. Zarins; Nirav D. Parikh

(22) Filed: **Apr. 24, 2014**

(57) **CLAIM**

The ornamental design for a faucet handle, as shown and described.

(51) **LOC (10) Cl.** **23-01**

DESCRIPTION

(52) **U.S. Cl.**
USPC **D23/252**

(58) **Field of Classification Search**
USPC D23/238–239, 241–243, 249–250, 252;
4/675–678; 137/801

FIG. 1 is a perspective view of a faucet handle showing my new design;
FIG. 2 is a top plan view thereof;
FIG. 3 is a left side view thereof, the opposite side being a mirror image of the side shown;
FIG. 4 is a bottom view thereof;
FIG. 5 is a front end view thereof; and,
FIG. 6 is a rear end view thereof.

See application file for complete search history.

1 Claim, 1 Drawing Sheet

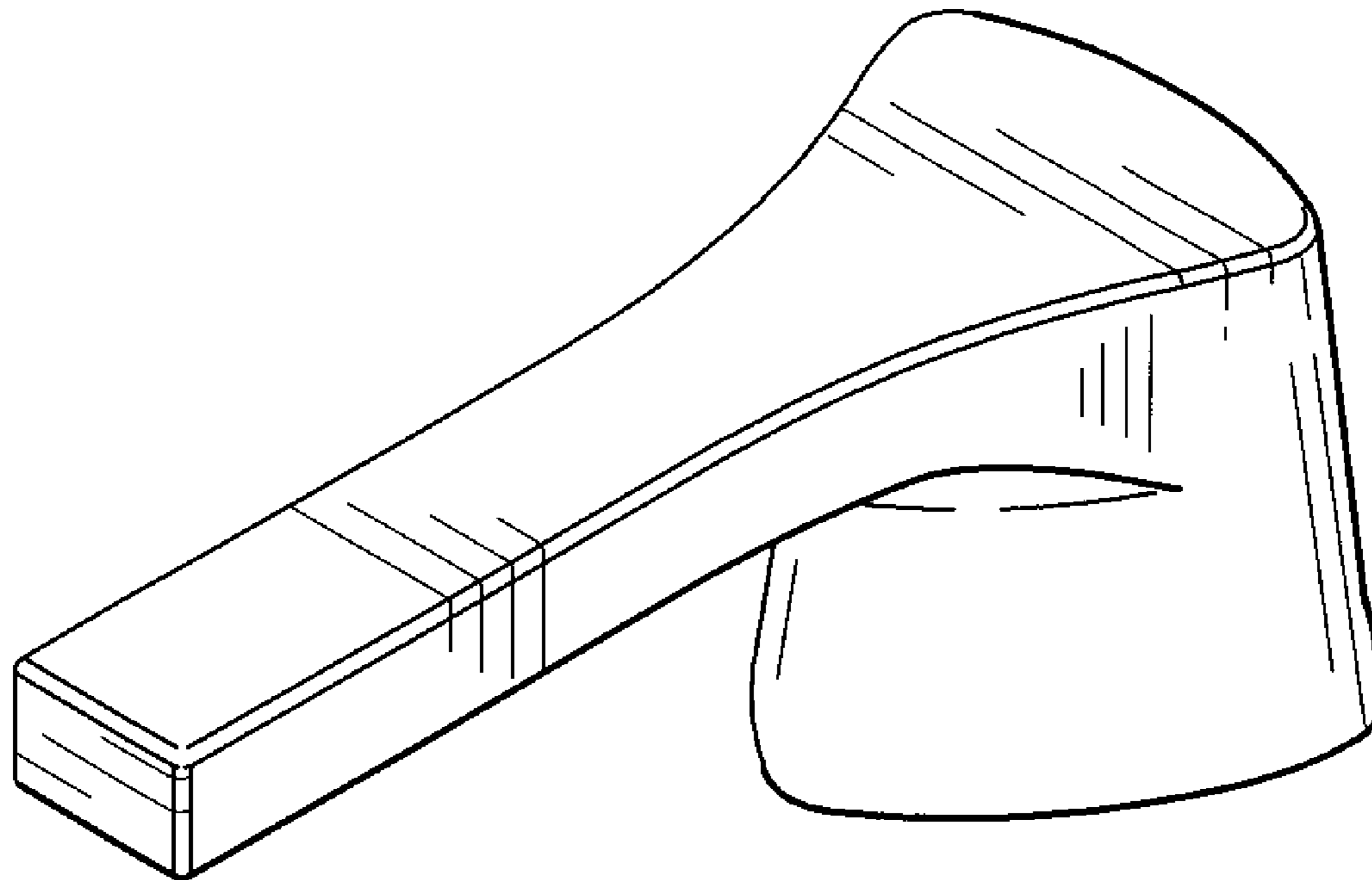

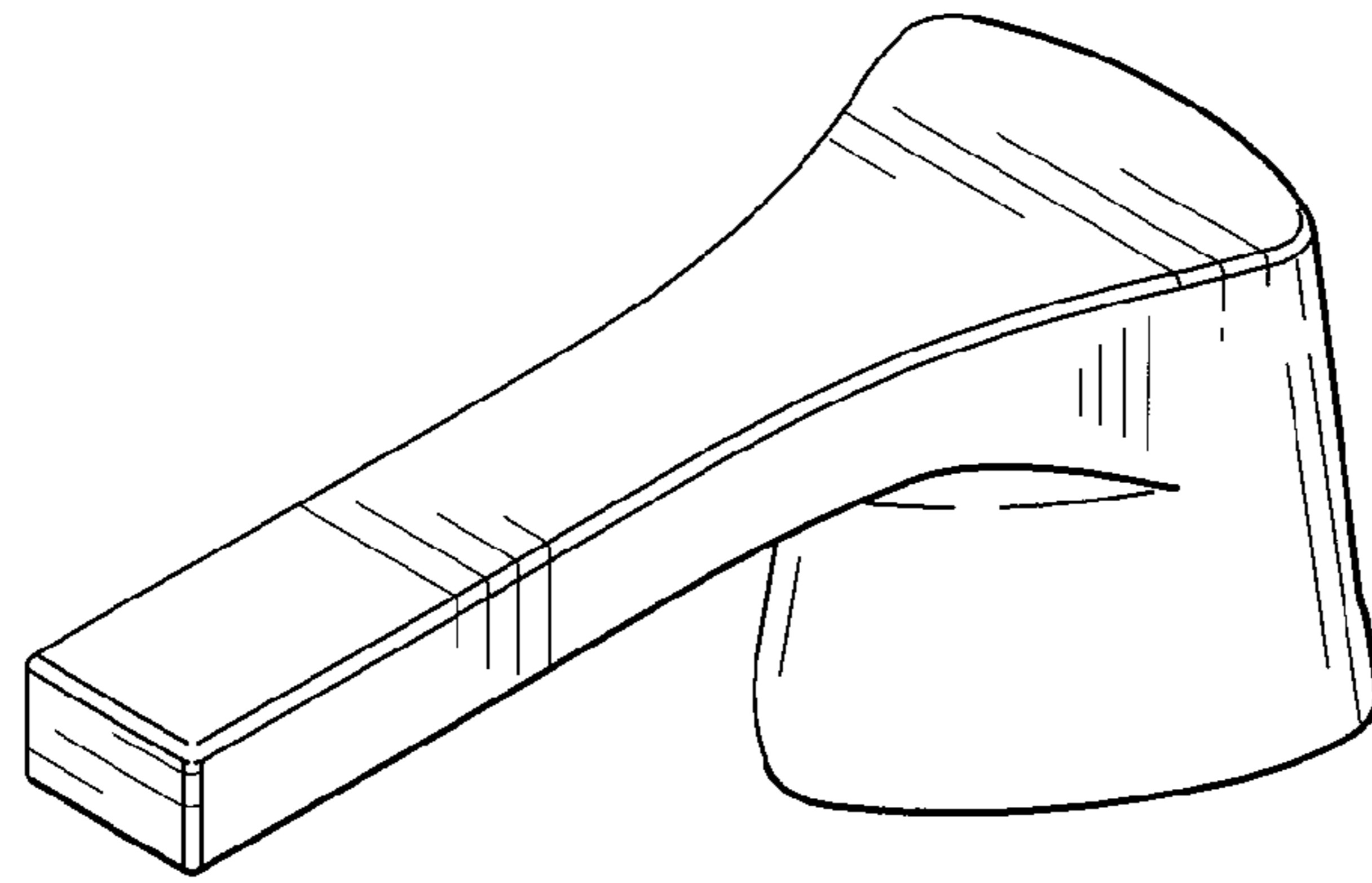

Fig-1

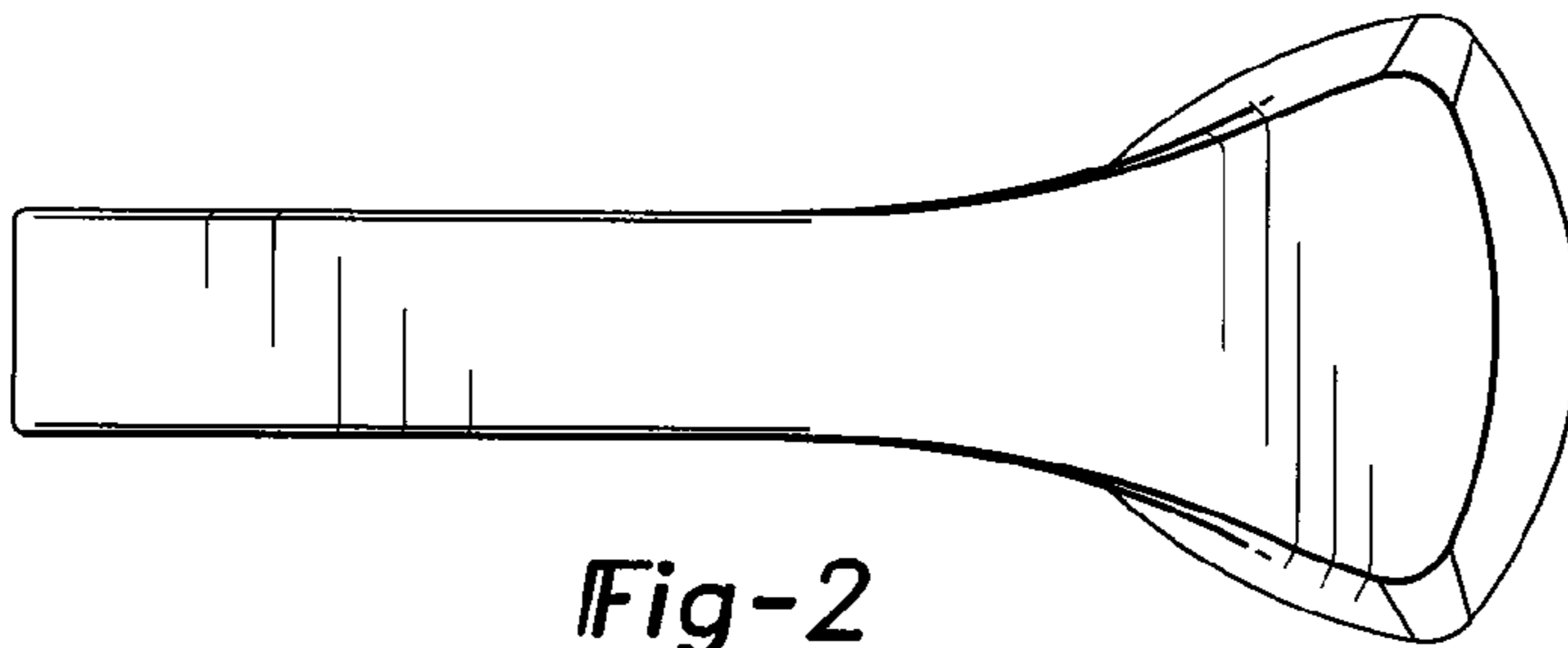

Fig-2

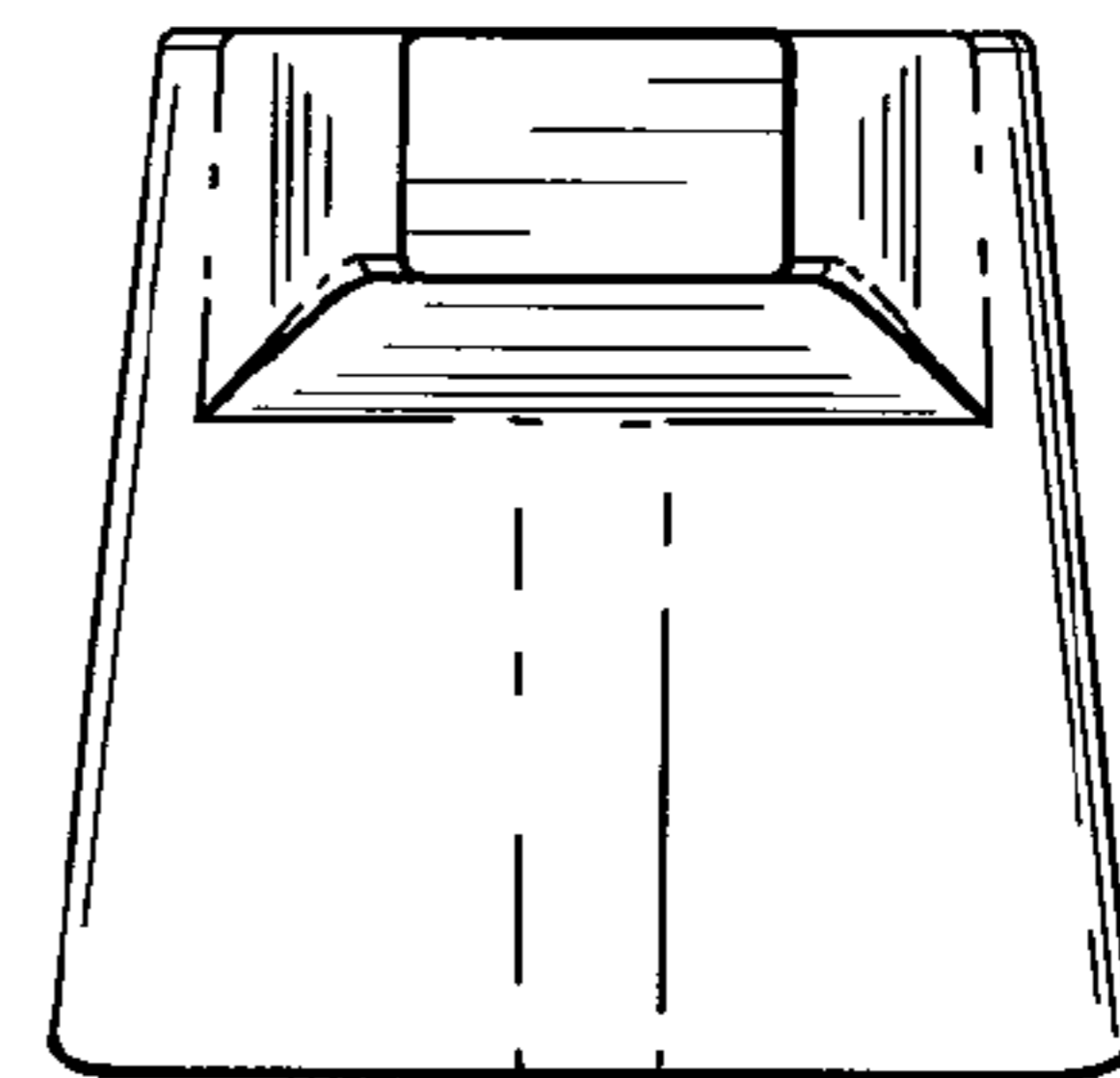

Fig-5

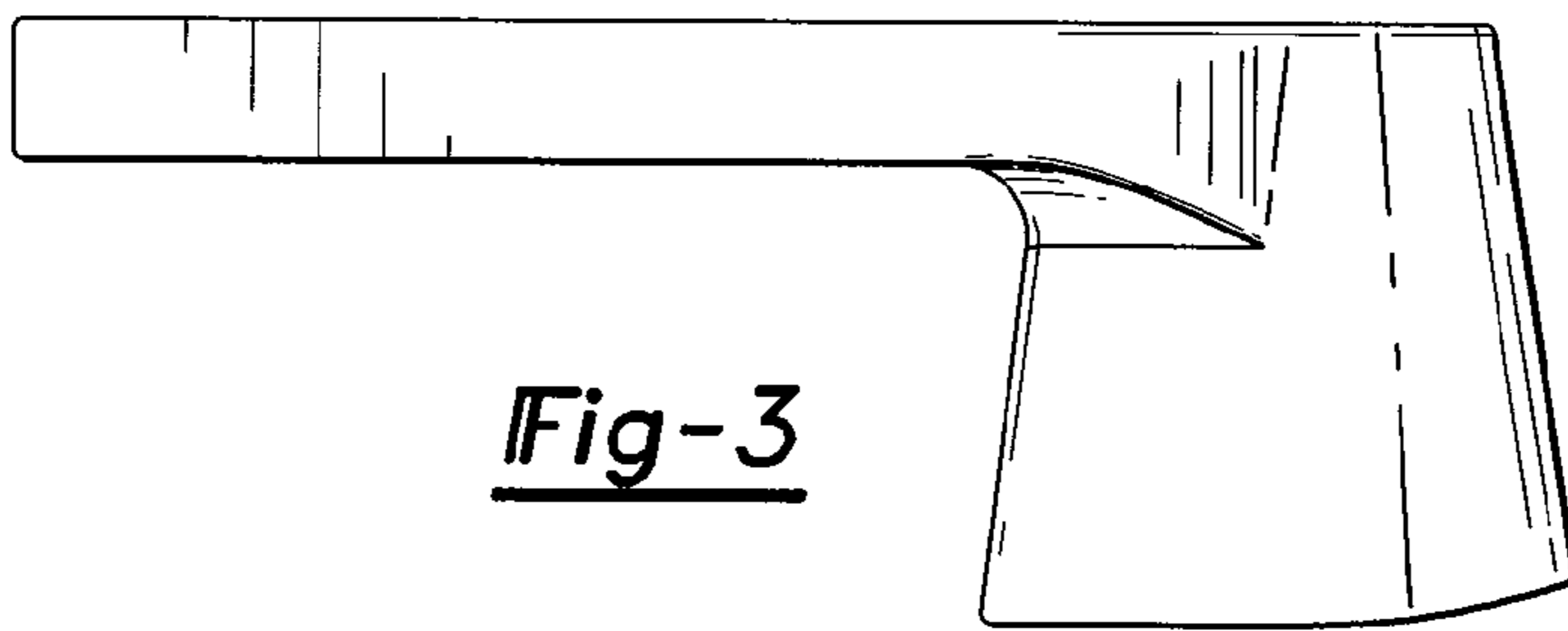

Fig-3

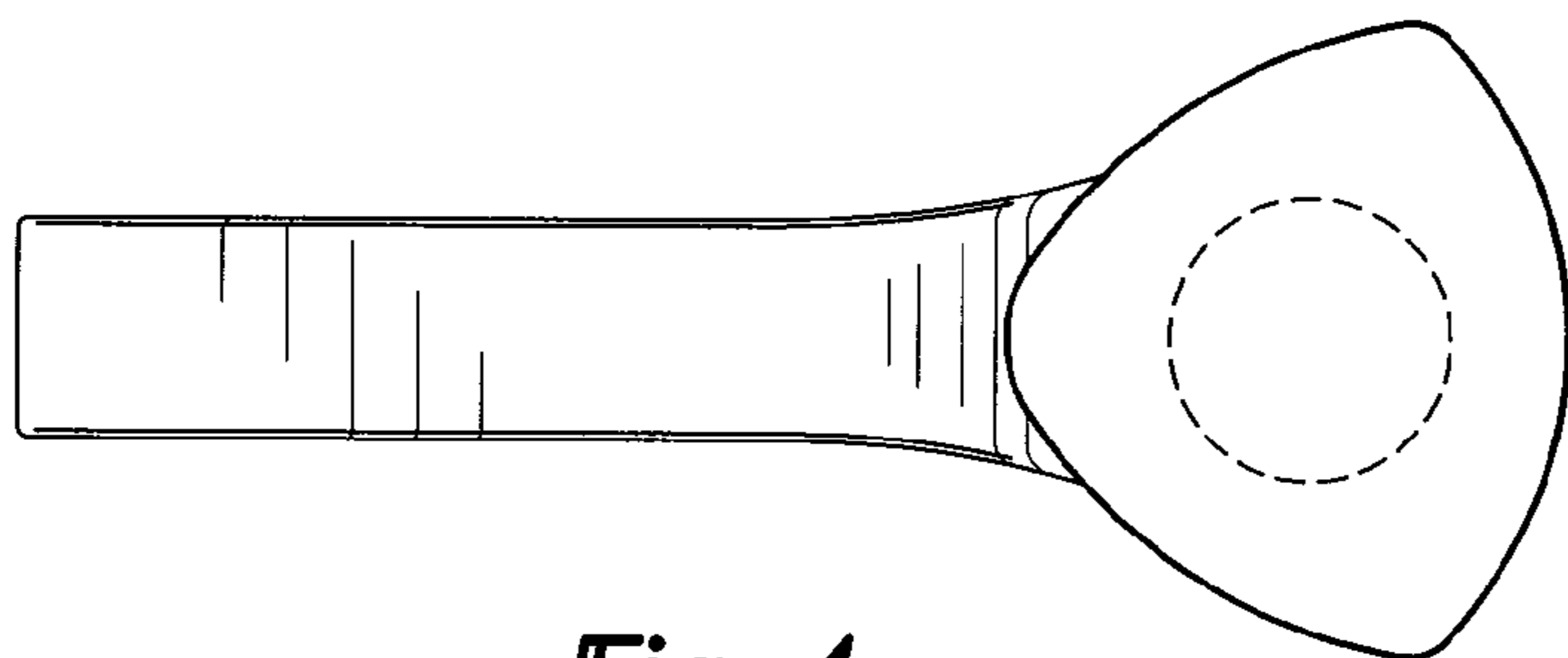

Fig-4

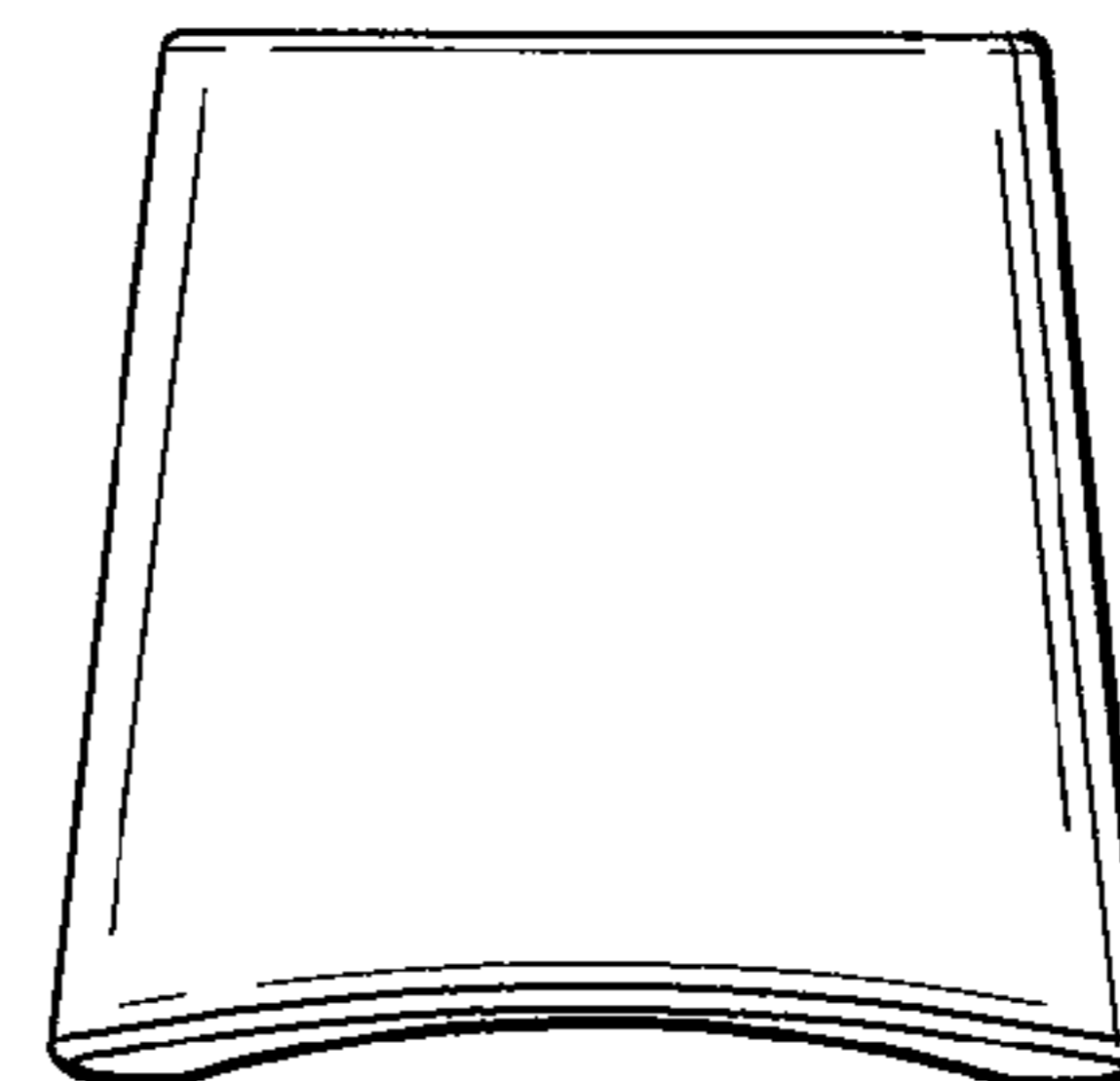

Fig-6